

000150



PLIERS AND VICES



14-23

WRENCHES AND SPANNERS



24-35

HAMMERS AND HATCHET



36-47

SOCKETS AND RATCHET HANDLES



48-61

SCREWDRIVERS, BITS AND HEXAGON KEYS



62-113

MEASURING TOOLS



114-131

CUTTING TOOLS

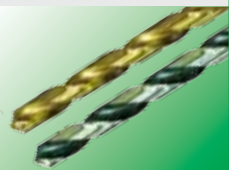

132-147

ABRASIVE TOOLS



148-161

KNIVES



162-175

SCISSORS



176-185

SAWS



186-201

GARDEN AND FARM TOOLS



202-219

BUILDING, WOODWORKING, PAINTING TOOLS



220-257

SAFETY AND PROTECTION



258-269

UNIVERSAL HARDWARE



270-275

CONSTRUCTION HARDWARE



276-283

HOUSEHOLD WARE



284-287

CONNECTING AND WELDING TOOLS



288-297

LIFTING AND TRANSPORTING TOOLS



298-303

VEHICLE REPAIRING



304-313

ELECTRICIAN'S TOOLS



314-321

LIGHTING APPLIANCES



322-329

POWER TOOLS



330-335

PNEUMATIC TOOLS



336-347

BOXES, CABINETS AND KITS



348-373



COMBINATION PLIERS

- ▶ Forged steel
- ▶ Polished
- ▶ Bi-color dipped handles



Item no.	Contents
10 10 00 01	5"
10 10 00 02	6"
10 10 00 03	7"
10 10 00 04	8"

LONG NOSE PLIERS

- ▶ Forged steel
- ▶ Polished
- ▶ Bi-color dipped handles



Item no.	Contents
10 10 30 01	5.5"
10 10 30 02	6"
10 10 30 03	7"
10 10 30 04	8"

ROUND NOSE PLIERS

- ▶ Forged steel
- ▶ Polished
- ▶ Bi-color dipped handles



Item no.	Contents
10 10 60 01	6"

DIAGONAL CUTTING PLIERS

- ▶ Forged steel
- ▶ Polished
- ▶ Bi-color dipped handles



Item no.	Contents
10 10 10 01	5.5"
10 10 10 02	6.5"
10 10 10 03	7.5"

BENT NOSE PLIERS

- ▶ Forged steel
- ▶ Polished
- ▶ Bi-color dipped handles



Item no.	Contents
10 10 40 01	5.5"
10 10 40 02	6"
10 10 40 03	7"
10 10 40 04	8"

END CUTTING PLIERS

- ▶ Forged steel
- ▶ Polished
- ▶ Bi-color dipped handles



Item no.	Contents
10 10 70 01	6"
10 10 70 02	7"
10 10 70 03	8"
10 10 70 04	10"

HEAVY DUTY DIAGONAL CUTTING PLIERS

- ▶ Forged steel
- ▶ Polished
- ▶ Bi-color dipped handles



Item no.	Contents
10 10 20 01	7"

FLAT NOSE PLIERS

- ▶ Forged steel
- ▶ Polished
- ▶ Bi-color dipped handles



Item no.	Contents
10 10 50 01	6"

SLIP JOINT PLIERS

- ▶ Light duty
- ▶ Forged steel
- ▶ Chrome-plated
- ▶ Dipped handles



Item no.	Contents
10 50 40 01	5"
10 50 40 02	6"
10 50 40 03	7"
10 50 40 04	8"
10 50 40 05	10"

SLIP JOINT PLIERS

- ▶ Heavy duty
- ▶ Forged steel
- ▶ Polished
- ▶ Bi-color dipped handles



Item no.	Contents
10 50 40 11	5"
10 50 40 12	6"
10 50 40 13	7"
10 50 40 14	8"
10 50 40 15	10"

LONG NOSE PLIERS

- ▶ Forged steel
- ▶ Polished
- ▶ Bi-color dipped handles



Item no.	Contents
10 10 99 05	7"
10 10 99 06	8"

POWER CRIMPING COMBINATION PLIERS

- ▶ Forged steel
- ▶ Polished
- ▶ Dipped handles



Item no.	Contents
10 10 99 10	10"

SLIP JOINT PLIERS

- ▶ With raised shoulder
- ▶ Forged steel
- ▶ Polished
- ▶ Bi-color dipped handles



Item no.	Contents
10 50 40 21	5"
10 50 40 22	6"
10 50 40 23	7"
10 50 40 24	8"
10 50 40 25	10"

POWER CRIMPING COMBINATION PLIERS

- ▶ Forged steel
- ▶ Polished
- ▶ Dipped handles



Item no.	Contents
10 10 99 07	10"

POWER CRIMPING COMBINATION PLIERS

- ▶ Forged steel
- ▶ Black oxidized & ground
- ▶ Dipped handles



Item no.	Contents
10 10 99 11	10"

POWER COMBINATION PLIERS

- ▶ Forged steel
- ▶ Polished
- ▶ Dipped handles



Item no.	Contents
10 10 99 08	10"

POWER CRIMPING COMBINATION PLIERS

- ▶ Forged steel
- ▶ Black oxidized & ground
- ▶ Dipped handles



Item no.	Contents
10 10 99 12	10"

COMBINATION PLIERS

- ▶ Forged steel
- ▶ Polished
- ▶ Bi-color dipped handles



Item no.	Contents
10 10 99 01	7"
10 10 99 02	8"

POWER COMBINATION PLIERS

- ▶ Forged steel
- ▶ Polished
- ▶ Dipped handles



Item no.	Contents
10 10 99 09	10"

LABORSAVING COMBINATION PLIER

- ▶ Forged steel
- ▶ Polished
- ▶ Bi-color dipped handles



Item no.	Contents
10 10 99 13	5"
10 10 99 14	7"

DIAGONAL CUTTING PLIERS

- ▶ Forged steel
- ▶ Polished
- ▶ Bi-color dipped handles



Item no.	Contents
10 10 99 03	6.5"
10 10 99 04	7.5"





LABORSAVING DIAGONAL PLIER

- ▶ Forged steel
- ▶ Polished
- ▶ Bi-color dipped handles



Item no.	Contents
10 10 99 15	5"
10 10 99 16	7"

LABORSAVING LONG NOSE PLIER

- ▶ Forged steel
- ▶ Polished
- ▶ Bi-color dipped handles



Item no.	Contents
10 10 99 17	5"
10 10 99 18	7"

COMBINATION PLIERS

- ▶ Forged steel
- ▶ Polished
- ▶ Bi-color plastic handles



Item no.	Contents
10 10 99 19	7"

DIAGONAL CUTTING PLIERS

- ▶ Forged steel
- ▶ Polished
- ▶ Bi-color plastic handles



Item no.	Contents
10 10 99 20	6"

LONG NOSE PLIERS

- ▶ Forged steel
- ▶ Polished
- ▶ Bi-color plastic handles



Item no.	Contents
10 10 99 21	6"

COMBINATION PLIERS

- ▶ With raised shoulder
- ▶ Forged steel / Cr-V
- ▶ Nickel-plated
- ▶ Bi-color dipped handles



Item no.	Contents
10 10 00 11	6"
10 10 00 12	7"
10 10 00 13	8"

DIAGONAL CUTTING PLIERS

- ▶ With raised shoulder
- ▶ Forged steel / Cr-V
- ▶ Nickel-plated
- ▶ Bi-color dipped handles



Item no.	Contents
10 10 10 11	6"
10 10 10 12	7"
10 10 10 13	8"

LONG NOSE PLIERS

- ▶ With raised shoulder
- ▶ Forged steel / Cr-V
- ▶ Nickel-plated
- ▶ Bi-color dipped handles



Item no.	Contents
10 10 30 11	6"
10 10 30 12	7"
10 10 30 13	8"

COMBINATION PLIERS

- ▶ Forged steel
- ▶ Nickel-plated
- ▶ Bi-color plastic handles



Item no.	Contents
10 10 00 21	5"
10 10 00 22	6"
10 10 00 23	7"
10 10 00 24	8"

DIAGONAL CUTTING PLIERS

- ▶ Forged steel
- ▶ Nickel-plated
- ▶ Bi-color plastic handles



Item no.	Contents
10 10 10 21	5.5"
10 10 10 22	6.5"
10 10 10 23	7.5"

HEAVY DUTY DIAGONAL CUTTING PLIERS

- ▶ Forged steel
- ▶ Nickel-plated
- ▶ Bi-color plastic handles



Item no.	Contents
10 10 20 21	7"

LONG NOSE PLIERS

- ▶ Forged steel
- ▶ Nickel-plated
- ▶ Bi-color plastic handles



Item no.	Contents
10 10 30 21	5.5"
10 10 30 22	6"
10 10 30 23	7"
10 10 30 24	8"

BENT NOSE PLIERS

- ▶ Forged steel
- ▶ Nickel-plated
- ▶ Bi-color plastic handles



Item no.	Contents
10 10 40 21	6.5"
10 10 40 22	8"

FLAT NOSE PLIERS

- ▶ Forged steel
- ▶ Nickel-plated
- ▶ Bi-color plastic handles



Item no.	Contents
10 10 50 21	6"

MINI COMBINATION PLIERS

- ▶ Forged steel
- ▶ Polished
- ▶ Bi-color dipped handles
- ▶ Double leaf spring



Item no.	Contents
10 15 00 01	4.5"

MINI FLAT NOSE PLIERS

- ▶ Forged steel
- ▶ Polished
- ▶ Bi-color dipped handles
- ▶ Double leaf spring



Item no.	Contents
10 15 50 01	4.5"

ROUND NOSE PLIERS

- ▶ Forged steel
- ▶ Nickel-plated
- ▶ Bi-color plastic handles



Item no.	Contents
10 10 60 21	6"

MINI DIAGONAL CUTTING PLIERS

- ▶ Forged steel
- ▶ Polished
- ▶ Bi-color dipped handles
- ▶ Double leaf spring



Item no.	Contents
10 15 10 01	4.5"

MINI ROUND NOSE PLIERS

- ▶ Forged steel
- ▶ Polished
- ▶ Bi-color dipped handles
- ▶ Double leaf spring



Item no.	Contents
10 15 60 01	4.5"

END CUTTING PLIERS

- ▶ Forged steel
- ▶ Polished
- ▶ Bi-color plastic handles



Item no.	Contents
10 10 70 21	6"
10 10 70 22	7"
10 10 70 23	8"
10 10 70 24	10"

MINI NEEDLE NOSE PLIERS

- ▶ Forged steel
- ▶ Polished
- ▶ Bi-color dipped handles
- ▶ Double leaf spring



Item no.	Contents
10 15 20 01	4.5"

MINI END CUTTING PLIERS

- ▶ Forged steel
- ▶ Polished
- ▶ Bi-color dipped handles
- ▶ Double leaf spring



Item no.	Contents
10 15 70 01	4.5"

WIRE STRIPPING PLIERS

- ▶ Forged steel
- ▶ Polished
- ▶ Bi-color plastic handles



Item no.	Contents
10 80 00 01	6"

MINI LONG NOSE PLIERS

- ▶ Forged steel
- ▶ Polished
- ▶ Bi-color dipped handles
- ▶ Double leaf spring



Item no.	Contents
10 15 30 01	4.5"

MINI COMBINATION PLIERS

- ▶ Forged steel
- ▶ Nickel plated
- ▶ Bi-color dipped handles
- ▶ Round spring
- ▶ With raised shoulder



Item no.	Contents
10 25 00 01	5"

MINI BENT NOSE PLIERS

- ▶ Forged steel
- ▶ Polished
- ▶ Bi-color dipped handles
- ▶ Double leaf spring



Item no.	Contents
10 15 40 01	4.5"





MINI DIAGONAL CUTTING PLIERS

- ▶ Forged steel
- ▶ Nickel plated
- ▶ Bi-color dipped handles
- ▶ Round spring
- ▶ With raised shoulder



Item no.	Contents
10 25 10 01	5"

MINI ROUND NOSE PLIERS

- ▶ Forged steel
- ▶ Nickel plated
- ▶ Bi-color dipped handles
- ▶ Round spring
- ▶ With raised shoulder

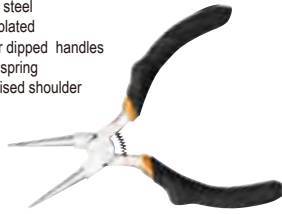

Item no.	Contents
10 25 60 01	5"

MINI LONG NOSE PLIERS

- ▶ Forged steel
- ▶ Polished
- ▶ Bi-color plastic handles
- ▶ Double leaf spring



Item no.	Contents
10 15 30 11	120 mm

MINI NEEDLE NOSE PLIERS

- ▶ Forged steel
- ▶ Nickel plated
- ▶ Bi-color dipped handles
- ▶ Round spring
- ▶ With raised shoulder

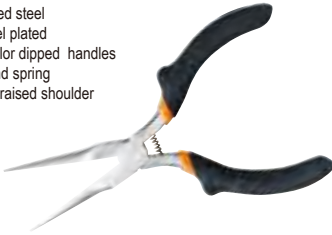

Item no.	Contents
10 25 20 01	5"

MINI END CUTTING PLIERS

- ▶ Forged steel
- ▶ Nickel plated
- ▶ Bi-color dipped handles
- ▶ Round spring
- ▶ With raised shoulder

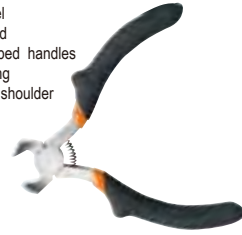

Item no.	Contents
10 25 70 01	5"

MINI BENT NOSE PLIERS, WITH CUTTER

- ▶ Forged steel
- ▶ Polished
- ▶ Bi-color plastic handles
- ▶ Double leaf spring



Item no.	Contents
10 15 40 11	120 mm

MINI LONG NOSE PLIERS

- ▶ Forged steel
- ▶ Nickel plated
- ▶ Bi-color dipped handles
- ▶ Round spring
- ▶ With raised shoulder



Item no.	Contents
10 25 30 01	5"

MINI COMBINATION PLIERS

- ▶ Forged steel
- ▶ Nickel plated
- ▶ Bi-color plastic handles
- ▶ Double leaf spring



Item no.	Contents
10 15 00 11	120 mm

MINI FLAT NOSE PLIERS

- ▶ Forged steel
- ▶ Polished
- ▶ Bi-color plastic handles
- ▶ Double leaf spring



Item no.	Contents
10 15 50 11	120 mm

MINI BENT NOSE PLIERS

- ▶ Forged steel
- ▶ Nickel plated
- ▶ Bi-color dipped handles
- ▶ Round spring
- ▶ With raised shoulder



Item no.	Contents
10 25 40 01	5"

MINI DIAGONAL CUTTING PLIERS

- ▶ Forged steel
- ▶ Polished
- ▶ Bi-color plastic handles
- ▶ Double leaf spring



Item no.	Contents
10 15 10 11	110 mm
10 15 10 12	120 mm

MINI ROUND NOSE PLIERS

- ▶ Forged steel
- ▶ Polished
- ▶ Bi-color plastic handles
- ▶ Double leaf spring



Item no.	Contents
10 15 60 11	120 mm

MINI FLAT NOSE PLIERS

- ▶ Forged steel
- ▶ Nickel plated
- ▶ Bi-color dipped handles
- ▶ Round spring
- ▶ With raised shoulder



Item no.	Contents
10 25 50 01	5"

MINI NEEDLE NOSE PLIERS

- ▶ Forged steel
- ▶ Polished
- ▶ Bi-color plastic handles
- ▶ Double leaf spring



Item no.	Contents
10 15 20 11	145 mm

MINI END CUTTING PLIERS

- ▶ Forged steel
- ▶ Polished
- ▶ Bi-color plastic handles
- ▶ Double leaf spring



Item no.	Contents
10 15 70 11	100 mm

8 PCS MINI PLIERS SET

- ▶ MINI COMBINATION PLIERS
- ▶ MINI LONG NOSE PLIERS
- ▶ MINI BENT NOSE PLIERS
- ▶ MINI DIAGONAL CUTTING PLIERS
- ▶ MINI END CUTTING PLIERS
- ▶ MINI FLAT NOSE PLIERS
- ▶ MINI NEEDLE NOSE PLIERS
- ▶ MINI ROUND NOSE PLIERS
- ▶ Polished
- ▶ Bi-color dipped handles
- ▶ Double leaf spring
- ▶ Packed in zipper bag



Item no.	Contents
10 90 00 02	5"

COMBINATION PLIERS

- ▶ Forged steel
- ▶ Nickel-plated
- ▶ Bi-color plastic handles



Item no.	Contents
10 20 00 01	160 mm
10 20 00 02	180 mm
10 20 00 03	200 mm

DIAGONAL CUTTING PLIERS

- ▶ Forged steel
- ▶ Nickel-plated
- ▶ Bi-color plastic handles



Item no.	Contents
10 20 10 01	160 mm

HEAVY DUTY SIDE CUTTER

- ▶ Forged steel
- ▶ Nickel-plated
- ▶ Bi-color plastic handles



Item no.	Contents
10 20 10 02	180 mm

POWER SIDE CUTTER

- ▶ Forged steel
- ▶ Nickel-plated
- ▶ Bi-color plastic handles



Item no.	Contents
10 20 20 01	180 mm

LONG NOSE PLIERS

- ▶ Forged steel
- ▶ Nickel-plated
- ▶ Bi-color plastic handles



Item no.	Contents
10 20 30 01	160 mm
10 20 30 02	200 mm

BENT NOSE PLIERS

- ▶ Forged steel
- ▶ Nickel-plated
- ▶ Bi-color plastic handles



Item no.	Contents
10 20 40 01	160 mm
10 20 40 02	200 mm

FLAT NOSE PLIERS

- ▶ Forged steel
- ▶ Nickel-plated
- ▶ Bi-color plastic handles



Item no.	Contents
10 20 50 01	160 mm

ROUND NOSE PLIERS

- ▶ Forged steel
- ▶ Nickel-plated
- ▶ Bi-color plastic handles



Item no.	Contents
10 20 60 01	160 mm

END CUTTER PLIERS

- ▶ Forged steel
- ▶ Nickel-plated
- ▶ Bi-color plastic handles



Item no.	Contents
10 20 70 01	160 mm

WIRE STRIPPING PLIERS

- ▶ Forged steel
- ▶ Nickel-plated
- ▶ Bi-color plastic handles



Item no.	Contents
10 20 80 02	160 mm

COMBINATION PLIERS

- ▶ Forged steel
- ▶ Nickel-plated
- ▶ Bi-color plastic handles, TPR



Item no.	Contents
10 20 00 11	160 mm
10 20 00 12	180 mm
10 20 00 13	200 mm





DIAGONAL CUTTING PLIERS

- ▶ Forged steel
- ▶ Nickel-plated
- ▶ Bi-color plastic handles, TPR



Item no.	Contents
10 20 10 11	160 mm

MINI FLAT NOSE PLIERS

- ▶ Forged steel
- ▶ Nickel-plated
- ▶ Bi-color plastic handles, TPR



Item no.	Contents
10 20 50 11	160 mm

HEAVY DUTY SIDE CUTTER

- ▶ Forged steel
- ▶ Nickel-plated
- ▶ Bi-color plastic handles, TPR



Item no.	Contents
10 20 20 11	180 mm

MINI ROUND NOSE PLIERS

- ▶ Forged steel
- ▶ Nickel-plated
- ▶ Bi-color plastic handles, TPR



Item no.	Contents
10 20 60 11	160 mm

LONG NOSE PLIERS

- ▶ Forged steel
- ▶ Nickel-plated
- ▶ Bi-color plastic handles, TPR



Item no.	Contents
10 20 30 11	160 mm
10 20 30 12	180 mm

WIRE STRIPPING PLIERS

- ▶ Forged steel
- ▶ Nickel-plated
- ▶ Bi-color plastic handles, TPR



Item no.	Contents
10 80 00 03	160 mm

BENT NOSE PLIERS

- ▶ Forged steel
- ▶ Nickel-plated
- ▶ Bi-color plastic handles, TPR



Item no.	Contents
10 20 40 11	160 mm
10 20 40 12	200 mm

HICEN PATENTED DESIGN PLASTIC HANGER



RECOMMENDATION HANDLES FROM HICEN

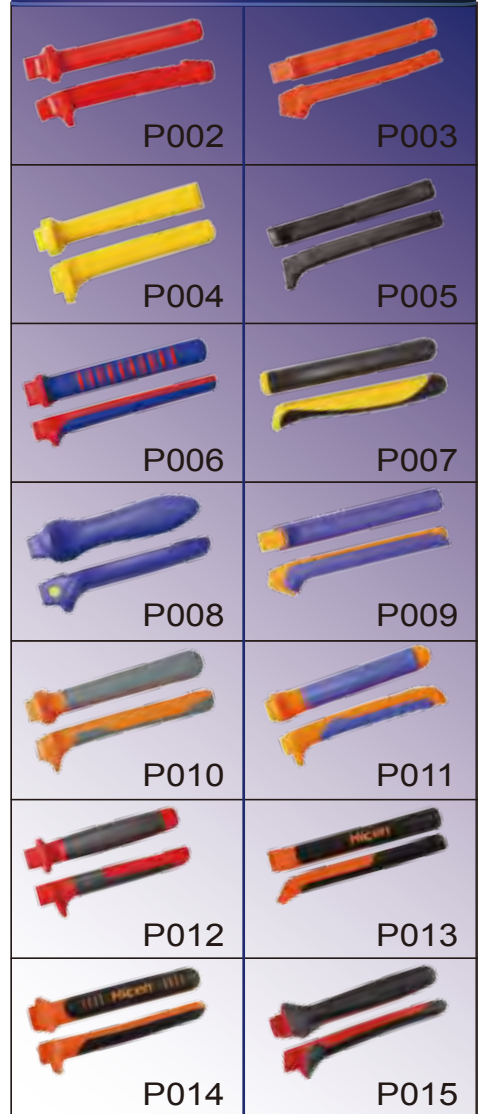

5PCS MINI PLIERS SET

- ▶ 4.5" combination plier
- ▶ 4.5" long nose plier
- ▶ 4.5" bent nose plier
- ▶ 4.5" diagonal cutting plier
- ▶ 4.5" end cutting plier



Item no.	Contents
10 90 60 01	

5PCS MINI PLIERS SET

- ▶ 4.5" combination plier
- ▶ 4.5" long nose plier
- ▶ 4.5" bent nose plier
- ▶ 4.5" diagonal cutting plier
- ▶ 4.5" flat nose plier



Item no.	Contents
10 90 60 04	

2PCS PLIERS SET

- ▶ 6" combination plier
- ▶ 4.5" combination plier



Item no.	Contents
10 90 60 07	

5PCS MINI PLIERS SET

- ▶ 4.5" flat nose plier
- ▶ 4.5" long nose plier
- ▶ 4.5" bent nose plier
- ▶ 4.5" diagonal cutting plier
- ▶ 4.5" end cutting plier



Item no.	Contents
10 90 60 02	

5PCS MINI PLIERS SET

- ▶ 4.5" combination plier
- ▶ 4.5" long nose plier
- ▶ 4.5" bent nose plier
- ▶ 4.5" diagonal cutting plier
- ▶ 4.5" end cutting plier



Item no.	Contents
10 90 60 05	

3PCS PLIERS SET

- ▶ 6" combination plier
- ▶ 6" long nose plier
- ▶ 6" diagonal cutting plier



Item no.	Contents
10 90 60 08	

8PCS MINI PLIERS SET

- ▶ 4.5" combination plier
- ▶ 4.5" long nose plier
- ▶ 4.5" bent nose plier
- ▶ 4.5" diagonal cutting plier
- ▶ 4.5" end cutting plier
- ▶ 4.5" flat nose plier
- ▶ 4.5" round nose plier
- ▶ 4.5" needle nose plier



Item no.	Contents
10 90 60 03	

2PCS PLIERS SET

- ▶ 6" long nose plier
- ▶ 4.5" long nose plier



Item no.	Contents
10 90 60 06	

3PCS PLIERS SET

- ▶ 6" combination plier
- ▶ 6" long nose plier
- ▶ 6" diagonal cutting plier



Item no.	Contents
10 90 60 09	



4PCS PLIERS SET

- ▶ 6" combination plier
- ▶ 6" long nose plier
- ▶ 6" diagonal cutting plier
- ▶ 6" wire stripping plier

Item no.	Contents
10 90 60 10	

4PCS PLIERS SET

- ▶ 6" combination plier
- ▶ 6" long nose plier
- ▶ 6" diagonal cutting plier
- ▶ 10" joint plier

Item no.	Contents
10 90 60 13	

3PCS PLIERS SET

- ▶ 8" Combination pliers
- ▶ 6" Diagonal cutting pliers
- ▶ 8" Slip joint pliers
- ▶ Polished
- ▶ Bi-color dipped handle

Item no.	Contents
10 90 60 16	

4PCS PLIERS SET

- ▶ 6" combination plier
- ▶ 6" long nose plier
- ▶ 6" diagonal cutting plier
- ▶ 6" joint plier

Item no.	Contents
10 90 60 11	

5PCS PLIERS SET

- ▶ 6" combination plier
- ▶ 6" long nose plier
- ▶ 6" diagonal cutting plier
- ▶ 6" wire stripping plier
- ▶ 10" joint plier

Item no.	Contents
10 90 60 14	

4PCS PLIERS SET

- ▶ 8" Combination pliers
- ▶ 6" Diagonal cutting pliers
- ▶ 6" Long nose pliers
- ▶ 8" Slip joint pliers
- ▶ Polished
- ▶ Bi-color dipped handle

Item no.	Contents
10 90 60 17	

4PCS PLIERS SET

- ▶ 7" combination plier
- ▶ 6" long nose plier
- ▶ 6" diagonal cutting plier
- ▶ 10" joint plier

Item no.	Contents
10 90 60 12	

3PCS PLIERS SET

- ▶ 6" Combination pliers
- ▶ 6" Diagonal cutting pliers
- ▶ 6" Long nose pliers
- ▶ Polished
- ▶ Bi-color dipped handle

Item no.	Contents
10 90 60 15	

4PCS PLIERS SET

- ▶ 180mm combination pliers
- ▶ 160mm long nose pliers
- ▶ 160mm diagonal cutting pliers
- ▶ 250mm box joint water pump pliers
- ▶ Black nickel-plated
- ▶ Bi-color plastic handles
- ▶ packing: double blister banding card

Item no.	Contents
10 90 60 18	

EXTRA LONG HANDLE LONG NOSE PLIERS

- ▶ 11" extra long handle
- ▶ Forged steel
- ▶ Polished
- ▶ Dipped handles



Item no.	Contents
10 30 00 01	0°
10 30 00 02	20°
10 30 00 03	45°
10 30 00 04	90°

EXTRA LONG HANDLE HOSE PLIERS

- ▶ Round tip
- ▶ 16" extra long handle
- ▶ Forged steel
- ▶ Polished
- ▶ Dipped handles



Item no.	Contents
10 30 00 12	5/16"
10 30 00 13	1/2"
10 30 00 14	3/4"

BOLT CUTTER

- ▶ Fixed arm
- ▶ Forged cutter jaws
- ▶ Black finished
- ▶ Steel tube handle with grips

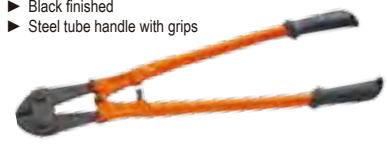

Item no.	Contents
10 40 00 02	12"
10 40 00 03	14"
10 40 00 04	18"
10 40 00 05	24"
10 40 00 06	30"
10 40 00 07	36"
10 40 00 08	42"

EXTRA LONG HANDLE HOSE PLIERS

- ▶ Round tip
- ▶ 11" extra long handle
- ▶ Forged steel
- ▶ Polished
- ▶ Dipped handles



Item no.	Contents
10 30 00 05	5/16"
10 30 00 06	1/2"
10 30 00 07	3/4"

LONG MINI PLIERS

- ▶ Forged steel
- ▶ Nickel plated
- ▶ Bi-color plastic handles
- ▶ Double leaf spring



Item no.	Contents
10 30 20 01	5.5" - 6"

BOLT CUTTER

- ▶ One arm adjustable
- ▶ Forged cutter jaws
- ▶ Black finished
- ▶ Steel tube handle with grips



Item no.	Contents
10 40 00 09	300 mm
10 40 00 10	350 mm
10 40 00 11	450 mm
10 40 00 12	600 mm
10 40 00 13	750 mm
10 40 00 14	900 mm

EXTRA LONG HANDLE LONG NOSE PLIERS

- ▶ 16" extra long handle
- ▶ Forged steel
- ▶ Polished
- ▶ Dipped handles



Item no.	Contents
10 30 00 08	0°
10 30 00 09	20°
10 30 00 10	45°
10 30 00 11	90°

POCKET BOLT CUTTER

- ▶ Forged cutter head
- ▶ Black finished
- ▶ Steel plate handle with grips



Item no.	Contents
10 40 00 01	8"

BOLT CUTTER

- ▶ Jaws edge adjusted by eccentric bolt
- ▶ Forged cutter jaws
- ▶ Black finished
- ▶ Steel tube handle with grips



Item no.	Contents
10 40 00 15	12"
10 40 00 16	14"
10 40 00 17	18"
10 40 00 18	24"
10 40 00 19	30"
10 40 00 20	36"
10 40 00 21	42"





BOLT CUTTER

- ▶ Jaws edge adjusted by eccentric bolt
- ▶ Forged cutter jaws
- ▶ Black finished
- ▶ Fully drop forged steel handle



Item no. Contents

10 40 00 22	12"
10 40 00 23	14"
10 40 00 24	18"
10 40 00 25	24"

BOLT CUTTER

- ▶ Jaws edge adjusted by eccentric bolt
- ▶ Forged cutter jaws
- ▶ Black finished
- ▶ Aluminum handle

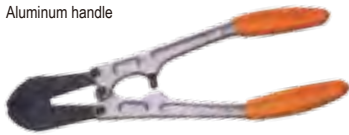

Item no. Contents

10 40 00 26	12"
10 40 00 27	14"
10 40 00 28	18"

CABLE CUTTER

- ▶ Forged steel
- ▶ Polished
- ▶ Dipped handle



Item no. Contents

10 80 40 01	6"
-------------	----

CABLE CUTTER

- ▶ Forged steel
- ▶ Polished
- ▶ Bi-color dipped handle



Item no. Contents

10 80 40 02	10"
-------------	-----

CABLE CUTTER

- ▶ Forged steel
- ▶ Polished
- ▶ Bi-color dipped handle



Item no. Contents

10 80 40 03	10"
-------------	-----

CABLE CUTTER

- ▶ Forged steel
- ▶ Polished
- ▶ Bi-color dipped handle



Item no. Contents

10 80 40 04	10"
-------------	-----

CABLE CUTTER

- ▶ Forged steel
- ▶ Polished
- ▶ Dipped handle



Item no. Contents

10 80 40 05	10"
-------------	-----

DOUBLE HANDLE PIPE WRENCH

- ▶ 90° bent nose



Item no. Contents

10 45 00 01	1"
10 45 00 02	1.5"
10 45 00 03	2"
10 45 00 04	3"
10 45 00 05	4"

DOUBLE HANDLE PIPE WRENCH

- ▶ 45° bent nose
- ▶ Straight jaws



Item no. Contents

10 45 00 06	1"
10 45 00 07	1.5"
10 45 00 08	2"

DOUBLE HANDLE PIPE WRENCH

- ▶ 45° bent nose
- ▶ Round jaws



Item no. Contents

10 45 00 09	1/2"
10 45 00 10	1"
10 45 00 11	1-1/2"
10 45 00 12	2"
10 45 00 13	3"



DOUBLE HANDLE PIPE WRENCH

- ▶ 45° bent nose
- ▶ S-shape jaws



Item no.	Contents
10 45 00 14	1/2"
10 45 00 15	1"
10 45 00 16	1-1/2"
10 45 00 17	2"
10 45 00 18	3"

AMERICAN TYPE PIPE WRENCH

- ▶ Heavy duty
- ▶ Casting iron frame
- ▶ Drop forged jaws
- ▶ Dipped handle



Item no.	Contents
10 45 00 34	8"
10 45 00 35	10"
10 45 00 36	12"
10 45 00 37	14"
10 45 00 38	18"
10 45 00 39	24"
10 45 00 40	36"
10 45 00 41	48"

SELF-ADJUSTABLE PIPE WRENCH

- ▶ Drop forged frame & jaws



Item no.	Contents
10 45 00 56	

AMERICAN TYPE PIPE WRENCH

- ▶ Light duty
- ▶ Casting iron frame
- ▶ Drop forged jaws



Item no.	Contents
10 45 00 20	8"
10 45 00 21	10"
10 45 00 22	12"
10 45 00 23	14"
10 45 00 24	18"
10 45 00 25	24"

OFFSET PIPE WRENCH

- ▶ Casting iron frame
- ▶ Drop forged jaws



Item no.	Contents
10 45 00 42	8"
10 45 00 43	10"
10 45 00 44	12"
10 45 00 45	14"
10 45 00 46	18"
10 45 00 47	24"
10 45 00 48	36"

ALUMINUM PIPE WRENCH

- ▶ Aluminum handle
- ▶ Drop forged jaws



Item no.	Contents
10 45 00 57	10"
10 45 00 58	12"
10 45 00 59	14"
10 45 00 60	18"
10 45 00 61	24"
10 45 00 62	36"
10 45 00 63	48"

AMERICAN TYPE PIPE WRENCH

- ▶ Heavy duty
- ▶ Casting iron frame
- ▶ Drop forged jaws



Item no.	Contents
10 45 00 26	8"
10 45 00 27	10"
10 45 00 28	12"
10 45 00 29	14"
10 45 00 30	18"
10 45 00 31	24"
10 45 00 32	36"
10 45 00 33	48"

BRITISH TYPE PIPE WRENCH

- ▶ Casting handle
- ▶ Drop forged frame & jaws



Item no.	Contents
10 45 00 49	8"
10 45 00 50	10"
10 45 00 51	12"
10 45 00 52	14"
10 45 00 53	18"
10 45 00 54	24"
10 45 00 55	36"

OFFSET ALUMINUM PIPE WRENCH

- ▶ Aluminum handle
- ▶ Drop forged jaws



Item no.	Contents
10 45 00 64	10"
10 45 00 65	12"
10 45 00 66	14"
10 45 00 67	18"
10 45 00 68	24"

CARPENTER'S PINCER

- ▶ Forged steel
- ▶ Sand-blasting finish
- ▶ Bi-color dipped handle



Item no.	Contents
10 40 20 01	6"
10 40 20 02	7"
10 40 20 03	8"

CARPENTER'S PINCER

- ▶ Forged steel
- ▶ Black finish



Item no. Contents

10 40 20 04	6"
10 40 20 05	7"
10 40 20 06	8"

TOWER PINCER

- ▶ Forged steel
- ▶ Black finish
- ▶ Dipped handle



Item no. Contents

10 40 20 07	8"
10 40 20 08	9"
10 40 20 09	10"

TOWER PINCER

- ▶ Forged steel
- ▶ Black finish



Item no. Contents

10 40 20 10	8"
10 40 20 11	9"
10 40 20 12	10"

END CUTTING PINCER

- ▶ Forged steel
- ▶ Black finished, polished head



Item no. Contents

10 20 70 02	6"
-------------	----

END CUTTING PINCER

- ▶ Forged steel
- ▶ Black finished
- ▶ Dipped handle



Item no. Contents

10 20 70 03	6"
10 20 70 04	7"
10 20 70 05	8"

3 PCS PLIERS SET

- ▶ 6" carpenter's pincer
- ▶ 9" tower pincer
- ▶ 10" box joint water pump pliers
- ▶ Forged steel
- ▶ Black finished
- ▶ Bi-color plastic handle



Item no. Contents

10 90 60 19	
-------------	--

A3 WATER PUMP PLIERS

- ▶ Forged steel
- ▶ Polished
- ▶ Bi-color dipped handle



Item no. Contents

10 45 20 01	6"
10 45 20 02	8"
10 45 20 03	10"
10 45 20 04	12"

A6 WATER PUMP PLIERS

- ▶ Forged steel
- ▶ Polished
- ▶ Bi-color dipped handle



Item no. Contents

10 45 20 05	8"
10 45 20 06	10"
10 45 20 07	12"

QUICK ADJUSTABLE WATER PUMP PLIERS

- ▶ Forged steel
- ▶ Jaws with plastic inserts
- ▶ Polished
- ▶ Dipped handle



Item no. Contents

10 45 20 09	11"
-------------	-----

QUICK ADJUSTABLE WATER PUMP PLIERS

- ▶ Forged steel
- ▶ Polished
- ▶ Bi-color dipped handle



Item no. Contents

10 45 20 10	11"
-------------	-----

QUICK ADJUSTABLE WATER PUMP PLIERS

- ▶ Forged steel
- ▶ Polished
- ▶ Bi-color dipped handle



Item no. Contents

10 45 20 11	6.5"
10 45 20 12	9"

D2 WATER PUMP PLIERS

- ▶ Forged steel
- ▶ Polished jaws
- ▶ Painted handle



Item no. Contents

10 45 20 13	250 mm
-------------	--------

D4 WATER PUMP PLIERS

- ▶ Forged steel
- ▶ Nickel plated
- ▶ Bi-color plastic handle



Item no. Contents

10 45 20 14	250 mm
-------------	--------

ADL. SYPHON PLIERS

- ▶ Forged steel
- ▶ Chrome plated
- ▶ Dipped handles



Item no.	Contents
10 45 20 15	9.5"

CIRCLIP PLIERS

- ▶ Straight external
- ▶ Bent external
- ▶ Straight internal
- ▶ Bent internal
- ▶ Forged steel
- ▶ Black finish



Item no.	Contents
10 90 30 01	6"
10 90 30 02	7"
10 90 30 03	8"

CIRCLIP PLIERS

- ▶ Straight external
- ▶ Bent external
- ▶ Straight internal
- ▶ Bent internal
- ▶ Forged steel
- ▶ Chrome-plated



Item no.	Contents
10 90 30 04	6"
10 90 30 05	7"
10 90 30 06	8"

CIRCLIP PLIERS

- ▶ Straight internal
- ▶ Forged steel
- ▶ Nickel plated
- ▶ Bi-color dipped handle



Item no.	Contents
10 50 00 01	5"
10 50 00 02	6"
10 50 00 03	7"
10 50 00 04	8"
10 50 00 05	9"
10 50 00 06	10"
10 50 00 07	12"

CIRCLIP PLIERS

- ▶ Straight internal
- ▶ Forged steel
- ▶ Nickel plated
- ▶ Bi-color dipped handle



Item no.	Contents
10 50 00 08	5"
10 50 00 09	6"
10 50 00 10	7"
10 50 00 11	8"
10 50 00 12	9"
10 50 00 13	10"
10 50 00 14	12"

CIRCLIP PLIERS

- ▶ Straight external
- ▶ Forged steel
- ▶ Nickel plated
- ▶ Bi-color dipped handle



Item no.	Contents
10 50 00 15	5"
10 50 00 16	6"
10 50 00 17	7"
10 50 00 18	8"
10 50 00 19	9"
10 50 00 20	10"
10 50 00 21	12"

CIRCLIP PLIERS

- ▶ Straight external
- ▶ Forged steel
- ▶ Nickel plated
- ▶ Bi-color dipped handle



Item no.	Contents
10 50 00 22	5"
10 50 00 23	6"
10 50 00 24	7"
10 50 00 25	8"
10 50 00 26	9"
10 50 00 27	10"
10 50 00 28	12"

CIRCLIP PLIERS

- ▶ Straight external
- ▶ Bent external
- ▶ Straight internal
- ▶ Bent internal
- ▶ Fully drop forged
- ▶ Black oxidized & ground
- ▶ Dipped handle



Item no.	Contents
10 50 00 29	5"
10 50 00 30	7"
10 50 00 31	9"

4 PCS CIRCLIP PLIERS SET

- ▶ 1pc Straight external head
- ▶ 1pc Bent external head
- ▶ 1pc Straight internal head
- ▶ 1pc Bent internal head
- ▶ Steel plate made
- ▶ Black finish
- ▶ Plastic handle



Item no.	Contents
10 90 30 07	6"



4 PCS CIRCLIP PLIERS SET

- ▶ 1pc 7" straight external pliers
- ▶ 1pc 7" bent external pliers
- ▶ 1pc 7" straight internal pliers
- ▶ 1pc 7" bent internal pliers
- ▶ Forged steel
- ▶ Nickel-plated
- ▶ Bi-color dipped handle
- ▶ Packing: BMC with window



Item no.	Contents
10 90 30 09	7"

FISHERMAN'S PLIER, WITH SPLIT RING TOOL

- ▶ Stainless steel construction with black Nickel plated finish
- ▶ Split ring tool, change out hooks easily
- ▶ Soft-grip handles allow a firm grip on the tool, even when wet



Item no.	Contents
10 60 00 01	6"

MINI SIDE CUTTER

- ▶ The perfect size to keep handy in pocket, boat dash or in tackle box.
- ▶ Firm plastic handles with soft insert for slip-resistant grip
- ▶ Soft-grip handles allow a firm grip on the tool, even when wet



Item no.	Contents
10 60 00 02	4.5"

FISHING PLIER, WITH SPLIT RING TOOL

- ▶ Stainless steel construction with black Nickel plated finish
- ▶ Split ring tool, change out hooks easily
- ▶ Soft-grip handles allow a firm grip on the tool, even when wet



Item no.	Contents
10 60 00 03	6"

FISHING PLIERS

- ▶ Forged steel
- ▶ Black nickel plated
- ▶ Plastic handle with leaf spring



Item no.	Contents
10 60 00 04	7"
10 60 00 05	9"

FISHING PLIERS

- ▶ Forged steel
- ▶ Black nickel plated
- ▶ Plastic handle with leaf spring



Item no.	Contents
10 60 00 06	7"
10 60 00 07	9"

FISHING PLIERS

- ▶ Forged steel
- ▶ Nickel plated
- ▶ Bi-color dipped handle with round spring



Item no.	Contents
10 60 00 08	6"

FISHING PLIERS

- ▶ Forged steel
- ▶ Nickel plated
- ▶ Bi-color dipped handle



Item no.	Contents
10 60 00 09	6"

FISHING PLIERS

- ▶ Forged steel
- ▶ Nickel plated
- ▶ Bi-color dipped handle



Item no.	Contents
10 60 00 10	7"
10 60 00 11	9"

LOCKING PLIERS

- ▶ CR type
- ▶ Hardened and tempered Jaws
- ▶ Nickel plated
- ▶ With Bi-color plastic handle



Item no.	Contents
10 50 20 01	5"
10 50 20 02	7"
10 50 20 03	10"

LOCKING PLIERS

- ▶ WR type
- ▶ Hardened and tempered Jaws
- ▶ Nickel plated



Item no.	Contents
10 50 20 04	4"
10 50 20 05	5"
10 50 20 06	7"
10 50 20 07	10"

LOCKING PLIERS

- ▶ CR type
- ▶ Hardened and tempered Jaws
- ▶ Nickel plated



Item no.	Contents
10 50 20 08	5"
10 50 20 09	7"
10 50 20 10	10"

LOCKING PLIERS

- ▶ CD type
- ▶ Hardened and tempered Jaws
- ▶ Nickel plated
- ▶ With Bi-color plastic handle



Item no.	Contents
10 50 20 14	5"
10 50 20 15	6.5"
10 50 20 16	9"

LOCKING PLIERS

- ▶ W type
- ▶ U-shape jaws, deep throated
- ▶ Nickel plated



Item no.	Contents
10 50 20 26	10"

SELF-ADJUSTABLE LOCKING PLIERS

- ▶ Hardened and tempered Jaws
- ▶ Black finished
- ▶ With plastic handle

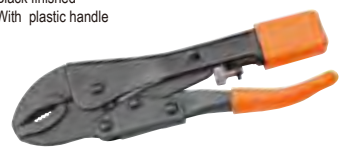

Item no.	Contents
10 50 20 29	7"
10 50 20 30	8"
10 50 20 31	10"

LOCKING PLIERS

- ▶ CD type
- ▶ Hardened and tempered Jaws
- ▶ Nickel plated



Item no.	Contents
10 50 20 17	5"
10 50 20 18	6.5"
10 50 20 19	9"

LOCKING PLIERS

- ▶ SM type
- ▶ Nickel plated



Item no.	Contents
10 50 20 27	10"

SELF-ADJUSTABLE LOCKING PLIERS

- ▶ Hardened and tempered Jaws
- ▶ Black finished
- ▶ With plastic handle



Item no.	Contents
10 50 20 32	8"
10 50 20 33	10"

LOCKING PLIERS

- ▶ R4 type
- ▶ Hardened and tempered Jaws
- ▶ Nickel plated



Item no.	Contents
10 50 20 20	10"

2 PCS LOCKING PLIERS SET

- ▶ 1 pc 9" CD type locking pliers
- ▶ 1 pc 10" WR type locking pliers
- ▶ Nickel plated
- ▶ With Bi-color plastic handle



Item no.	Contents
10 90 60 20	

LOCKING GRIP PLIERS

- ▶ Hardened and tempered Jaws
- ▶ Black finished
- ▶ With plastic handle



Item no.	Contents
10 50 20 34	4"
10 50 20 35	5"
10 50 20 36	7"
10 50 20 37	10"

LOCKING PLIERS

- ▶ C type
- ▶ Swivel pad C-clamp
- ▶ Nickel plated



Item no.	Contents
10 50 20 21	5"
10 50 20 22	6"
10 50 20 23	9"
10 50 20 24	11"
10 50 20 25	18"

3 PCS LOCKING PLIERS SET

- ▶ 1 pc 6.5" CD type locking pliers
- ▶ 1 pc 7" WR type locking pliers
- ▶ 1 pc 10" WR type locking pliers
- ▶ Nickel plated
- ▶ With Bi-color plastic handle



Item no.	Contents
10 90 60 21	

REVOLVING PUNCH PLIERS

- ▶ Chrome-plated
- ▶ With dipped handle



Item no.	Contents
10 65 00 01	9"





REVOLVING PUNCH PLIERS

- ▶ Chrome-plated



Item no.	Contents
10 65 00 02	9"

FENCING PLIERS

- ▶ Forged carbon steel
- ▶ 2 wire cutter
- ▶ with dipped handle



Item no.	Contents
10 65 40 01	10"

LIGHT STEEL KEEL CLAMP

- ▶ Casting Alu. frame & steel plate handle
- ▶ Chrome plated
- ▶ Dipped handle



Item no.	Contents
10 50 60 05	10"

REVOLVING PUNCH PLIERS

- ▶ Chrome-plated



Item no.	Contents
10 65 00 03	9"

TILE CUTTER

- ▶ Forged steel
- ▶ Black finish
- ▶ Dipped handle
- ▶ With spring



Item no.	Contents
10 50 60 01	8"

LIGHT STEEL KEEL CLAMP

- ▶ Steel plate made
- ▶ Plastic powder coated
- ▶ Dipped handle



Item no.	Contents
10 50 60 06	12"

EYELET-PLIERS

- ▶ Chrome plated with 100 piece eyelets

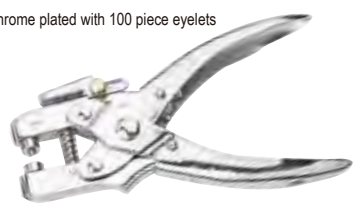

Item no.	Contents
10 65 00 04	7"

TILE CUTTER

- ▶ Forged steel
- ▶ Black finish
- ▶ Dipped handle
- ▶ With round spring



Item no.	Contents
10 50 60 02	8"

LIGHT STEEL KEEL CLAMP

- ▶ Casting Steel made
- ▶ Chrome plated
- ▶ With plastic handle



Item no.	Contents
10 50 60 07	12"

EYELET-PLIERS

- ▶ Chrome plated
- ▶ Dipped handle



Item no.	Contents
10 65 00 05	7"

TILE CUTTER

- ▶ Forged steel
- ▶ Black finish, polished jaw
- ▶ Bi-color dipped handle
- ▶ With spring



Item no.	Contents
10 50 60 03	190 mm

BENCH VICE

- ▶ Stationary base without anvil
- ▶ Hardened and tempered Jaws
- ▶ Lacquered



Item no.	Contents
10 70 00 01	3"
10 70 00 02	4"
10 70 00 03	5"
10 70 00 04	6"
10 70 00 05	8"

2 PCS PUNCH & EYELET PLIERS SET

- ▶ 1 pc revolving punch pliers
- ▶ 1 pc eyelet pliers
- ▶ With 100 eyelets
- ▶ Chrome plated
- ▶ Dipped handle



Item no.	Contents
10 90 50 08	

TILE CUTTER

- ▶ Forged steel
- ▶ Black finish
- ▶ Dipped handle



Item no.	Contents
10 50 60 04	190 mm

BENCH VICE

- ▶ Stationary base without anvil
- ▶ Hardened and tempered Jaws
- ▶ Lacquered



Item no.	Contents
10 70 00 06	3"
10 70 00 07	4"
10 70 00 08	5"
10 70 00 09	6"
10 70 00 10	8"

BENCH VICE

- ▶ Stationary base without anvil
- ▶ Hardened and tempered Jaws
- ▶ Lacquered



Item no.	Contents
10 70 00 11	3"
10 70 00 12	4"
10 70 00 13	5"
10 70 00 14	6"
10 70 00 15	8"

BENCH VICE

- ▶ Stationary base without anvil
- ▶ Hardened and tempered Jaws
- ▶ Lacquered



Item no.	Contents
10 70 00 16	3"
10 70 00 17	4"
10 70 00 18	5"
10 70 00 19	6"
10 70 00 20	8"

UNIVERSAL TABLE VICE

- ▶ Casting Aluminum



Item no.	Contents
10 70 00 21	70 mm

TABLE VICE

- ▶ Swivel base with anvil
- ▶ Lacquered



Item no.	Contents
10 70 00 22	50 mm
10 70 00 23	60 mm
10 70 00 24	65 mm

TABLE VICE

- ▶ With 2 guide bar
- ▶ Lacquered



Item no.	Contents
10 70 00 25	2"
10 70 00 26	2.5"
10 70 00 27	3"



VICE FOR DRILL PRESS

- ▶ Hardened and tempered Jaws
- ▶ Black finish thread bar & handle



Item no.	Contents
10 70 00 28	3"
10 70 00 39	4"
10 70 00 30	5"
10 70 00 31	6"

VICE FOR DRILL PRESS

- ▶ Hardened and tempered Jaws
- ▶ Chrome-plated thread bar & handle



Item no.	Contents
10 70 00 32	3"
10 70 00 33	4"
10 70 00 34	5"
10 70 00 35	6"

ALUMINUM VICE

- ▶ Casting aluminum frame
- ▶ Black finish thread bar & plastic handle



Item no.	Contents
10 70 00 36	60 mm

ANGLE ALUMINUM VICE

- ▶ Casting aluminum frame
- ▶ Black finish thread bar & plastic handle



Item no.	Contents
10 70 00 37	60 mm



BENCH VICE FOR WOOD WORKING

- ▶ With 2 guide bar
- ▶ Lacquered



Item no. Contents

10 70 00 38	6"
10 70 00 39	8"

ANVIL

- ▶ Casting iron
- ▶ Lacquered



Item no. Contents

10 70 00 40	5 kg
10 70 00 41	10 kg
10 70 00 42	25 kg
10 70 00 43	50 kg
10 70 00 44	75 kg

AUTOMATIC WIRE STRIPPER

- ▶ Automatic clamping action and length gauge facility ensure stripped ends are uniform strip five insulation or wire diameter
- ▶ 1.0,1.6,2.0,3.2mm spring loaded moulded grips



Item no. Contents

10 80 00 04	180 mm
-------------	--------

AUTOMATIC WIRE STRIPPER

- ▶ Steel body with nylon reinforced moving handles
- ▶ Wire stripper and cable cutter



Item no. Contents

10 80 00 05	165 mm
-------------	--------

ADJUSTABLE AUTOMATIC WIRE STRIPPER

- ▶ Steel body with nylon reinforced moving handles
- ▶ Wire stripper and cable cutter
- ▶ Wire adj. screw



Item no. Contents

10 80 00 06	
-------------	--

CRIMPING AND STRIPPING PLIERS

- ▶ Hardened Steel
- ▶ Black finished
- ▶ With size printing, crimping for 1.5-6 mm²
- ▶ Stripping for 0.75-6.0 mm 2
- ▶ With heavy duty 2 components plastic handle



Item no. Contents

10 80 00 07	
-------------	--

PROFESSIONAL MULTI-PURPOSE WIRE CUTTER AND CRIMPING PLIERS

- ▶ Hardened steel, black finish, laser printing
- ▶ Wire cutting for standard size as AWG 24-12
- ▶ Crimping for AWG 22-10
- ▶ With dipped handle



Item no. Contents

10 80 00 08	
-------------	--

PROFESSIONAL WIRE STRIPPER PLIERS

- ▶ Hardened steel
- ▶ Black finished, stamped scale
- ▶ With lock, with two component dipped handle
- ▶ With cutter
- ▶ Wire stripping for AWG 22-10, 0.6-2.6 mm
- ▶ With dipped handle



Item no. Contents

10 80 00 09	6"
-------------	----



WIRE STRIPPER PLIERS

- ▶ Hardened steel
- ▶ Black electrophoretic lacquered
- ▶ Lased scale
- ▶ Wire stripping for AWG24-12
- ▶ Strong plastic handle
- ▶ With lock
- ▶ In blister card



Item no. Contents

10 80 00 11	6"
-------------	----

WIRE STRIPPER PLIERS

- ▶ Hardened steel
- ▶ Black electrophoretic lacquered
- ▶ Lased scale
- ▶ Wire stripping for AWG30-20
- ▶ Strong plastic handle
- ▶ With lock
- ▶ In blister card



Item no. Contents

10 80 00 12	6"
-------------	----

HEAVY DUTY WIRE STRIPPER AND CRIMPER PLIERS

- ▶ Hardened steel
- ▶ Black electrophoretic lacquered, lased scale
- ▶ Wire stripping for standard size as AWG26-10
- ▶ Crimping for AWG26-10
- ▶ With cutter
- ▶ With dipped handle
- ▶ In double blister



Item no. Contents

10 80 00 13	8.5"
-------------	------

WIRE TWISTING PLIERS

- ▶ Hardened steel



Item no. Contents

10 80 30 01	
-------------	--

WIRE STRIPPING & CRIMPING PLIERS

- ▶ Hardened steel
- ▶ Black electrophoretic lacquered
- ▶ Lased scale
- ▶ Strong plastic handle

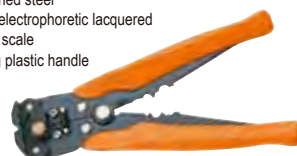

Item no. Contents

10 80 10 01	9"
-------------	----

CRIMPING PLIERS

- ▶ For the terminals from 0.5-6 mm
- ▶ For crimping cord and insulation in one operation
- ▶ Ratchet controlled
- ▶ Adjustable handle opening
- ▶ Jaws made of precision die-cast



Item no.	Contents
10 80 10 02	260 mm

MULTI-FUNCTION CRIMPING PLIERS

- ▶ Forged blades tubular handle with grips
- ▶ For cutting 6mm wire rope
- ▶ For pressing 1/16"-3/16"



Item no.	Contents
10 80 10 03	14"
10 80 10 04	24"

WIRE ROPE CUTTER

- ▶ Forged blades
- ▶ With dipped handle



Item no.	Contents
10 40 00 29	

WIRE ROPE CUTTER

- ▶ Forged blades tubular handle with grips



Item no.	Contents
10 40 00 30	18"
10 40 00 31	32"

2-IN-1 MODULAR TELEPHONE PLUG CRIMPER

- ▶ For cutting
- ▶ Stripping
- ▶ Crimping 2 type of plug 8P, 6P
- ▶ Embedded cable cutter and stripper
- ▶ Ergonomically ratcheting frame
- ▶ With 12 pcs 8P plug & 12 pcs 6P plug
- ▶ With 2 m telephone cords
- ▶ In double blister



Item no.	Contents
10 80 20 01	

COMPUTER PLIERS

- ▶ For crimping modular plug 4P4C & 4P2C
- ▶ Embedded cable cutter and stripper



Item no.	Contents
10 80 20 02	190 mm

COMPUTER PLIERS

- ▶ For crimping modular plug 6P6C/RJ-12, 6P6C/RJ-11& 6P2C; 8P8C/RJ-45, 8P6C, 8P4C& 8P2C
- ▶ Embedded cable cutter and stripper
- ▶ With ratchet



Item no.	Contents
10 80 20 03	185 mm

HYDRAULIC CRIMPING TOOLS

- ▶ For crimping cable copper 16-400mm² and Alu. Terminal bushing 10-300mm²
- ▶ Hexagonal mould is adopted to ensure tight press connection
- ▶ Crimping force 12 Ton, safety system inside



Item no.	Contents
10 99 00 01	12 Ton

CABLE CUTTER

- ▶ For cutting copper & Alu. Cable only
- ▶ Max. capacity ≤960 mm²



Item no.	Contents
10 80 40 06	870 mm



ADJUSTABLE WRENCH

- ▶ Forged carbon steel
- ▶ Hardened
- ▶ Chrome plated/satin nickel plated/satin chrome plated/black nickel plated/lacquer painting/black finish and head polished



Item no.	Contents
13 40 00 01	4"/100mm
13 40 00 02	6"/150mm
13 40 00 03	8"/200mm
13 40 00 04	10"/250mm
13 40 00 05	12"/300mm
13 40 00 06	15"/375mm
13 40 00 07	18"/450mm

ADJUSTABLE WRENCH

- ▶ Forged carbon steel
- ▶ Hardened
- ▶ Chrome plated/satin nickel plated/satin chrome plated/black nickel plated/lacquer painting/black finish and head polished



Item no.	Contents
13 40 00 08	2.5"/60mm
13 40 00 09	4"/100mm
13 40 00 10	6"/150mm
13 40 00 11	8"/200mm
13 40 00 12	10"/250mm
13 40 00 13	12"/300mm
13 40 00 14	15"/375mm
13 40 00 15	18"/450mm

ADJUSTABLE WRENCH

- ▶ Forged carbon steel
- ▶ Hardened
- ▶ Black phosphate finish
- ▶ With scale on the fixed jaws



Item no.	Contents
13 40 00 16	4"/100mm
13 40 00 17	6"/150mm
13 40 00 18	8"/200mm
13 40 00 19	10"/250mm
13 40 00 20	12"/300mm
13 40 00 21	15"/375mm

HEAVY DUTY ADJUSTABLE WRENCH

- ▶ Forged carbon steel
- ▶ Hardened
- ▶ Chrome plated,
- ▶ With matte dipped handles



Item no.	Contents
13 40 40 01	4"/100mm
13 40 40 02	6"/150mm
13 40 40 03	8"/200mm
13 40 40 04	10"/250mm
13 40 40 05	12"/300mm

PROFESSIONAL ADJUSTABLE WRENCH

- ▶ Made of carbon steel/Cr-v steel
- ▶ Matte chrome-plated
- ▶ With non-slip injection plastic handle
- ▶ Hardened and milled jaws
- ▶ Precise duct of snail-wheel
- ▶ With scale on the fixed jaws



Item no.	Contents
13 40 20 01	6"/150mm
13 40 20 02	8"/200mm
13 40 20 03	10"/250mm
13 40 20 04	12"/300mm

PROFESSIONAL ADJUSTABLE WRENCH

- ▶ Made of carbon steel/Cr-v steel
- ▶ Matte chrome-plated
- ▶ With non-slip injection plastic handle
- ▶ Hardened and milled jaws
- ▶ Precise duct of snail-wheel
- ▶ With scale on the fixed jaws



Item no.	Contents
13 40 20 05	6"/150mm
13 40 20 06	8"/200mm
13 40 20 07	10"/250mm
13 40 20 08	12"/300mm

PROFESSIONAL ADJUSTABLE WRENCH

- ▶ Made of carbon steel/Cr-v steel
- ▶ Matte chrome-plated
- ▶ With non-slip injection plastic handle
- ▶ Hardened and milled jaws
- ▶ Precise duct of snail-wheel
- ▶ With scale on the fixed jaws



Item no.	Contents
13 40 20 09	6"/150mm
13 40 20 10	8"/200mm
13 40 20 11	10"/250mm
13 40 20 12	12"/300mm

PROFESSIONAL ADJUSTABLE WRENCH

- ▶ Made of Cr-v steel
- ▶ Black nickel plated
- ▶ With 2 colors non-slip injection plastic handle
- ▶ Hardened and milled jaws
- ▶ Precise duct of snail-wheel
- ▶ With scale on the fixed jaws
- ▶ Middle hex hole
- ▶ Hanging hole can be used as an offset ring spanner



Item no.	Contents
13 40 20 13	6"/150mm
13 40 20 14	8"/200mm
13 40 20 15	10"/250mm
13 40 20 16	12"/300mm

PROFESSIONAL ADJUSTABLE WRENCH

- ▶ Made of Cr-v steel
- ▶ heavy duty head
- ▶ satin nickel plated
- ▶ With non-slip injection plastic handle
- ▶ Hardened and milled jaws
- ▶ Precise duct of snail-wheel
- ▶ With scale on the fixed jaws
- ▶ Middle hex hole
- ▶ Hanging hole can be used as an offset ring spanner



Item no. Contents

13 40 20 17	6"/150mm
13 40 20 18	8"/200mm
13 40 20 19	10"/250mm
13 40 20 20	12"/300mm

PROFESSIONAL ADJUSTABLE WRENCH

- ▶ Made of Cr-v steel
- ▶ satin nickel plated
- ▶ With 2 colors non-slip injection plastic handle
- ▶ Whole wrench is heat-treated and milled jaws
- ▶ Precise duct of snail-wheel
- ▶ With scale on the fixed jaws
- ▶ Bigger jaw opening with laser carved scale
- ▶ Torque up to ANSI standard



Item no. Contents

13 40 20 21	6"/150mm
13 40 20 22	8"/200mm
13 40 20 23	10"/250mm
13 40 20 24	12"/300mm

PROFESSIONAL ADJUSTABLE WRENCH

- ▶ Made of Cr-v steel
- ▶ Heavy duty head
- ▶ Satin nickel plated
- ▶ With non-slip injection plastic handle
- ▶ Hardened and milled jaws
- ▶ Precise duct of snail-wheel
- ▶ With scale on the fixed jaws
- ▶ Middle hex hole



Item no. Contents

13 40 20 25	6"/150mm
13 40 20 26	8"/200mm
13 40 20 27	10"/250mm
13 40 20 28	12"/300mm



PROFESSIONAL ADJUSTABLE WRENCH

- ▶ Made of Cr-v steel
- ▶ Black finish
- ▶ With 2 colors non-slip injection plastic handle
- ▶ Hardened and milled jaws
- ▶ Precise duct of snail-wheel
- ▶ With scale on the fixed jaws



Item no. Contents

13 40 20 29	6"/150mm
13 40 20 30	8"/200mm
13 40 20 31	10"/250mm
13 40 20 32	12"/300mm

PROFESSIONAL ADJUSTABLE WRENCH

- ▶ Made of Cr-v steel
- ▶ Satin chrome plated
- ▶ With 2 colors non-slip injection plastic handle
- ▶ Hardened and milled jaws
- ▶ Precise duct of snail-wheel
- ▶ With scale on the fixed jaws
- ▶ Bigger jaw opening with laser carved scale
- ▶ Torque up to ANSI standard



Item no. Contents

13 40 20 33	6"/150mm
13 40 20 34	8"/200mm
13 40 20 35	10"/250mm
13 40 20 36	12"/300mm

STUBBY ADJUSTABLE WRENCH

- ▶ Made of forged carbon steel
- ▶ Black finish & polished head
- ▶ With non-slip injection plastic handle
- ▶ Hardened and milled jaws
- ▶ Precise duct of snail-wheel
- ▶ With scale on the fixed jaws



Item no. Contents

13 40 20 37	6"/150mm
-------------	----------

STUBBY ADJUSTABLE WRENCH

- ▶ Made of forged carbon steel
- ▶ Black finish & polished head
- ▶ With 2 color non-slip injection plastic handle
- ▶ Hardened and milled jaws
- ▶ Precise duct of snail-wheel
- ▶ With scale on the fixed jaws



Item no. Contents

13 40 20 38	6"/150mm
-------------	----------

STUBBY ADJUSTABLE WRENCH

- ▶ Made of forged carbon steel
- ▶ Black finish & polished head
- ▶ With 2 components non-slip injection plastic handle
- ▶ Hardened and milled jaws
- ▶ Precise duct of snail-wheel
- ▶ With scale on the fixed jaws
- ▶ Bigger jaw opening with laser carved scale



Item no. Contents

13 40 20 39	6"/150mm
-------------	----------

STUBBY ADJUSTABLE WRENCH

- ▶ Made of Cr-v steel
- ▶ Head fine polished
- ▶ With 2 colors non-slip injection plastic handle
- ▶ Whole wrench is heat-treated and milled jaws
- ▶ Precise duct of snail-wheel
- ▶ With scale on the fixed jaws
- ▶ Bigger jaw opening with laser carved scale
- ▶ Compact wrench body fit to small working space



Item no. Contents

13 40 20 40	6"/150mm
-------------	----------

3PCS ADJUSTABLE WRENCH SET

- ▶ Made of carbon steel
- ▶ Matte chrome-plated
- ▶ Without handle
- ▶ Hardened and milled jaws
- ▶ Precise duct of snail-wheel
- ▶ With scale on the fixed jaws
- ▶ Double blister card



Item no. Contents

13 90 40 01	6"- 8"- 10"
-------------	-------------

STUBBY ADJUSTABLE WRENCH

- ▶ Made of carbon steel
- ▶ Matte chrome-plated
- ▶ With non-slip injection plastic handle
- ▶ Hardened and milled jaws
- ▶ Precise duct of snail-wheel
- ▶ With scale on the fixed jaws
- ▶ Double blister card with tie



Item no. Contents

13 90 40 02	6"- 8"- 10"
-------------	-------------



DOUBLE OPEN END WRENCH

- ▶ Forged carbon steel/chrome vanadium steel
- ▶ With raised panel/recessed panel/fully polished
- ▶ Hardened
- ▶ Chrome-plated



Item no.	Contents
13 20 00 01	6x7
13 20 00 02	8x9
13 20 00 03	10x11
13 20 00 04	12x13
13 20 00 05	14x15
13 20 00 06	16x17
13 20 00 07	18x19
13 20 00 08	20x22
13 20 00 09	21x23
13 20 00 10	24x27
13 20 00 11	25x28
13 20 00 12	30x32

COMBINATION WRENCH

- ▶ Forged carbon steel/chrome vanadium steel
- ▶ With raised panel/recessed panel/fully polished
- ▶ Hardened
- ▶ Chrome-plated



Item no.	Contents
13 30 20 01	6
13 30 20 02	7
13 30 20 03	8
13 30 20 04	9
13 30 20 05	10
13 30 20 06	11
13 30 20 07	12
13 30 20 08	13
13 30 20 09	14
13 30 20 10	15
13 30 20 11	16
13 30 20 12	17
13 30 20 13	18
13 30 20 14	19
13 30 20 15	20
13 30 20 16	21
13 30 20 17	22
13 30 20 18	23
13 30 20 19	24
13 30 20 20	27
13 30 20 21	30
13 30 20 22	32

DEEP OFFSET COMBINATION WRENCH

- ▶ Forged carbon steel/chrome vanadium steel
- ▶ With raised panel/recessed panel/fully polished
- ▶ Hardened
- ▶ Chrome-plated



Item no.	Contents
13 30 20 23	6
13 30 20 24	7
13 30 20 25	8
13 30 20 26	9
13 30 20 27	10
13 30 20 28	11
13 30 20 29	12
13 30 20 30	13
13 30 20 31	14
13 30 20 32	15
13 30 20 33	16
13 30 20 34	17
13 30 20 35	18
13 30 20 36	19
13 30 20 37	20
13 30 20 38	21
13 30 20 39	22
13 30 20 40	23
13 30 20 41	24
13 30 20 42	27
13 30 20 43	30
13 30 20 44	32

DOUBLE RING WRENCH

- ▶ Forged carbon steel/chrome vanadium steel
- ▶ With raised panel/recessed panel/fully polished
- ▶ Hardened
- ▶ Chrome-plated



Item no.	Contents
13 20 40 01	6x7
13 20 40 02	8x9
13 20 40 03	10x11
13 20 40 04	12x13
13 20 40 05	14x15
13 20 40 06	16x17
13 20 40 07	18x19
13 20 40 08	20x22
13 20 40 09	21x23
13 20 40 10	24x27
13 20 40 11	25x28
13 20 40 12	30x32

DOUBLE OPEN END WRENCH SET

- ▶ Forged carbon steel
- ▶ With fully polished
- ▶ Hardened
- ▶ Chrome-plated
- ▶ In PVC pouch



Item no.	Contents
13 90 20 01	6PCS Size: 6x7 8x9 10x11 12x13 14x15 16x17 MM
13 90 20 02	8PCS Size: 6x7 8x9 10x11 12x13 14x15 16x17 18x19 20x22MM
13 90 20 03	10PCS Size: 6x7 8x9 10x11 12x13 14x15 16x17 18x19 20x22 21x23 24x27MM
13 90 20 04	12PCS Size: 6x7 8x9 10x11 12x13 14x15 16x17 18x19 20x22 21x23 24x27 25x28 30x32 MM

DOUBLE OPEN END WRENCH SET

- ▶ Forged carbon steel
- ▶ With fully polished with dipped handle
- ▶ Hardened
- ▶ Chrome-plated
- ▶ In PVC pouch

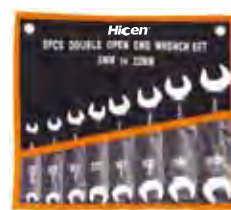

Item no.	Contents
13 90 20 05	6PCS Size: 6x7 8x9 10x11 12x13 14x15 16x17 MM
13 90 20 06	8PCS Size: 6x7 8x9 10x11 12x13 14x15 16x17 18x19 20x22MM
13 90 20 07	10PCS Size: 6x7 8x9 10x11 12x13 14x15 16x17 18x19 20x22 21x23 24x27MM
13 90 20 08	12PCS Size: 6x7 8x9 10x11 12x13 14x15 16x17 18x19 20x22 21x23 24x27 25x28 30x32 MM



DOUBLE OPEN END WRENCH SET

- ▶ Forged chrome vanadium steel
- ▶ With recessed panel
- ▶ Hardened
- ▶ Chrome-plated
- ▶ In plastic holder



Item no.	Contents
13 90 20 09	6PCS Size: 6x7 8x9 10x11 12x13 14x15 16x17 MM
13 90 20 10	8PCS Size: 6x7 8x9 10x11 12x13 14x15 16x17 18x19 20x22MM
13 90 20 11	10PCS Size: 6x7 8x9 10x11 12x13 14x15 16x17 18x19 20x22 21x23 24x27MM
13 90 20 12	12PCS Size: 6x7 8x9 10x11 12x13 14x15 16x17 18x19 20x22 21x23 24x27 25x28 30x32 MM

COMBINATION WRENCH SET

- ▶ Forged chrome vanadium steel
- ▶ With recessed panel
- ▶ Hardened
- ▶ Chrome plated
- ▶ In plastic holder



Item no.	Contents
13 90 30 01	6PCS Size: 8-10-11-12-14-17MM
13 90 30 02	8PCS Size: 8-9-10-12-13-14-17-19MM
13 90 30 03	10PCS Size: 8-9-10-11-12-13-15-17-19-22MM
13 90 40 04	12PCS Size: 6-7-8-9-10-11-12-13-14-17-19-22MM

STUBBY TYPE DOUBLE OPEN END WRENCH SET

- ▶ Forged carbon steel
- ▶ With mirror polished
- ▶ Chrome plated
- ▶ In plastic holder



Item no.	Contents
13 90 20 21	6x7 8x9 10x11 12x13 14x15 16x17MM

STUBBY TYPE COMBINATION WRENCH SET

- ▶ Forged carbon steel
- ▶ With mirror polished
- ▶ Chrome plated
- ▶ In plastic holder



Item no.	Contents
13 90 20 22	8-10-12-14-17-19MM

6PCS DOUBLE RING WRENCH SET

- ▶ Forged chrome vanadium steel
- ▶ With recessed panel
- ▶ Hardened
- ▶ Chrome-plated
- ▶ In plastic holder



Item no.	Contents
13 90 20 13	6PCS Size: 6x7 8x9 10x11 12x13 14x15 16x17 MM
13 90 20 14	8PCS Size: 6x7 8x9 10x11 12x13 14x15 16x17 18x19 20x22MM
13 90 20 15	10PCS Size: 6x7 8x9 10x11 12x13 14x15 16x17 18x19 20x22 21x23 24x27MM
13 90 20 16	12PCS Size: 6x7 8x9 10x11 12x13 14x15 16x17 18x19 20x22 21x23 24x27 25x28 30x32 MM

COMBINATION WRENCH SET

- ▶ Forged carbon steel
- ▶ With fully polished
- ▶ Hardened
- ▶ Chrome-plated
- ▶ In PVC pouch



Item no.	Contents
13 90 30 06	6PCS Size: 8-10-11-12-14-17MM
13 90 30 07	8PCS Size: 8-9-10-12-13-14-17-19MM
13 90 30 08	10PCS Size: 8-9-10-11-12-13-15-17-19-22MM
13 90 40 09	12PCS Size: 6-7-8-9-10-11-12-13-14-17-19-22MM

7PCS METRIC STUBBY COMBINATION WRENCH SET

- ▶ Drop forged chrome vanadium steel, hardened & tempered for high strength and durability
- ▶ Mirror polished, chrome plated
- ▶ Mini type for easy working
- ▶ Packed in double blister card with tray



Item no.	Contents
13 90 30 11	8,10,11,12,13,14,15mm

DOUBLE RING WRENCH SET

- ▶ Forged carbon steel
- ▶ With fully polished
- ▶ Hardened
- ▶ Chrome-plated
- ▶ In PVC pouch



Item no.	Contents
13 90 20 17	6PCS Size: 6x7 8x9 10x11 12x13 14x15 16x17 MM
13 90 20 18	8PCS Size: 6x7 8x9 10x11 12x13 14x15 16x17 18x19 20x22MM
13 90 20 19	10PCS Size: 6x7 8x9 10x11 12x13 14x15 16x17 18x19 20x22 21x23 24x27MM
13 90 20 20	12PCS Size: 6x7 8x9 10x11 12x13 14x15 16x17 18x19 20x22 21x23 24x27 25x28 30x32 MM

STUBBY TYPE DOUBLE RING WRENCH SET

- ▶ Forged carbon steel
- ▶ With mirror polished
- ▶ Chrome plated
- ▶ In plastic holder



Item no.	Contents
13 90 30 10	6x7 8x9 10x11 12x13 14x15 16x17MM



FLARE NUT WRENCH

- ▶ Drop forged carbon steel/chrome vanadium steel
- ▶ Sand blasting and chrome plated
- ▶ Hexagon type / Ring type head



Item no.	Contents
13 20 00 21	6x8mm
13 20 00 22	10x11mm
13 20 00 23	12x14mm
13 20 00 24	16x17mm
13 20 00 25	18x19mm
13 20 00 26	22x24mm



WRENCHES AND SPANNERS

6 PCS FLARE NUT SPANNER

- ▶ Professional quality
- ▶ Bent head for easy working
- ▶ Drop forged carbon steel
- ▶ Fully polished and chrome plated
- ▶ Packing in plastic holder



Item no.	Contents
13 90 20 24	6X8mm,10X11mm, 12X14mm,16X17mm, 18X19mm,22X24mm

6 PCS FLEXIBLE COMBINATION SOCKET WRENCH SET

- ▶ Professional quality
- ▶ Drop forged carbon steel
- ▶ Head polished, expert satin chrome plated raised panel
- ▶ Socket head 180° adjustable for easy working



Item no.	Contents
13 90 30 12	10mm,12mm,13mm,14mm, 17mm,19mm

6 PCS DOUBLE RING FLEXIBLE SOCKET WRENCH SET

- ▶ High quality tool steel
- ▶ Satin chrome plated
- ▶ Socket heads polished
- ▶ Expert hardened
- ▶ 180° adjustable for easy working
- ▶ Packing in plastic box



Item no.	Contents
13 90 20 25	8X9mm,10X11mm, 12X13mm,14X15mm, 17X19mm

DOUBLE RING GEAR WRENCH

- ▶ #40 chrome steel, #50 chrome vanadium steel gear
- ▶ 72 teeth
- ▶ Fully polished satin chrome plated/mirror polished chrome plated



Item no.	Contents
13 20 60 01	8x9
13 20 60 02	10x11
13 20 60 03	12x13
13 20 60 04	14x15
13 20 60 05	16x17
13 20 60 06	18x19
13 20 60 07	20x22
13 20 60 08	23x24

6PCS DOUBLE RING GEAR WRENCH SET

- ▶ #40 chrome steel,#50 chrome vanadium steel gear
- ▶ 72 teeth
- ▶ Fully polished satin chrome plated/mirror polished chrome plated, plastic holder packing



Item no.	Contents
13 90 20 26	8x9,10x11,12x13,14x15, 16x17,18x19

5PCS DOUBLE RING GEAR WRENCH SET

- ▶ Made of #40Cr-v steel
- ▶ Dropped forged and heat treatment
- ▶ fully polished chrome plated
- ▶ 12 edges ring, black finish, 72 teeth
- ▶ packed in blow mould case
- ▶ Size:6X8 10X11 12X13 14X15 17X19MM;



Item no.	Contents
13 90 20 27	6x8,10x11,12x13,14x15, 17x19 mm

FLEXIBLE DOUBLE RING GEAR WRENCH

- ▶ #40 chrome steel, #50 chrome vanadium steel gear
- ▶ 72 teeth
- ▶ Fully polished satin chrome plated/mirror polished chrome plated



Item no.	Contents
13 20 60 09	8x9
13 20 60 10	10x11
13 20 60 11	12x13
13 20 60 12	14x15
13 20 60 13	16x17
13 20 60 14	18x19
13 20 60 15	20x22
13 20 60 16	23x24

DOG BONE WRENCH

- ▶ Cr-V steel, chrome plated
- ▶ With magnetic tip for easy hang up



Item no.	Contents
13 60 00 01	12,13,14,15,16,17,18,19/ 8,10,12,13,14,17,19,21 3/8,7/16,1/2,9/16,5/8, 11/16,3/4,13/16

FLEXIBLE DOUBLE RING GEAR WRENCH SET

- ▶ #40 chrome steel,#50 chrome vanadium steel gear
- ▶ 72 teeth
- ▶ Fully polished satin chrome plated/mirror polished chrome plated, packed in blow mould case



Item no.	Contents
13 90 20 28	8x9,10x11,12x13,14x15, 16x17,17x19 mm

REVERSIBLE DOUBLE RING GEAR WRENCH

- ▶ #40 chrome steel, #50 chrome vanadium steel gear
- ▶ 72 teeth
- ▶ Fully polished satin chrome plated/mirror polished chrome plated



Item no.	Contents
13 20 60 17	8x9
13 20 60 18	10x11
13 20 60 19	12x13
13 20 60 20	14x15
13 20 60 21	16x17
13 20 60 22	18x19
13 20 60 23	20x22
13 20 60 24	23x24

REVERSIBLE DOUBLE RING GEAR WRENCH SET

- ▶ #40 chrome steel, #50 chrome vanadium steel gear
- ▶ 72 teeth
- ▶ Fully polished satin chrome plated/mirror polished chrome plated, packed in pouch



Item no.	Contents
13 90 20 29	8x9, 10x11, 12x13, 14x15, 16x17, 18x19 mm

REVERSIBLE GEAR WRENCH SET

- ▶ #40 chrome steel, #50 chrome vanadium steel gear
- ▶ 72 teeth
- ▶ Fully polished satin chrome plated/mirror polished chrome plated, packed in pouch



Item no.	Contents
13 90 30 13	8-10-12-13-14-17



GEAR WRENCH

- ▶ #40 chrome steel, #50 chrome vanadium steel gear
- ▶ 72 teeth
- ▶ Fully polished satin chrome plated/mirror polished chrome plated



Item no.	Contents
13 30 00 01	6
13 30 00 02	7
13 30 00 03	8
13 30 00 04	9
13 30 00 05	10
13 30 00 06	11
13 30 00 07	12
13 30 00 08	13
13 30 00 09	14
13 30 00 10	15
13 30 00 11	16
13 30 00 12	17
13 30 00 13	18
13 30 00 14	19
13 30 00 15	20
13 30 00 16	21
13 30 00 17	22
13 30 00 18	23
13 30 00 19	24
13 30 00 20	27
13 30 00 21	30
13 30 00 22	32

GEAR WRENCH SET

- ▶ #40 chrome steel, #50 chrome vanadium steel gear
- ▶ 72 teeth
- ▶ Fully polished satin chrome plated/mirror polished chrome plated, plastic holder packing



Item no.	Contents
13 90 30 14	5PCS Size: 8-10-12-13-14mm
13 90 30 15	6PCS Size: 8-10-12-13-14-17mm
13 90 30 16	8PCS Size: 8-10-11-12-14-16-17-19mm
13 90 30 17	12PCS Size: 8-9-10-11-12-13-14-15-16-17-18-19mm

FLEXIBLE GEAR WRENCH

- ▶ #40 chrome steel, #50 chrome vanadium steel gear
- ▶ 72 teeth
- ▶ Fully polished satin chrome plated/mirror polished chrome plated



Item no.	Contents
13 30 00 23	6
13 30 00 24	7
13 30 00 25	8
13 30 00 26	9
13 30 00 27	10
13 30 00 28	11
13 30 00 29	12
13 30 00 30	13
13 30 00 31	14
13 30 00 32	15
13 30 00 33	16
13 30 00 34	17
13 30 00 35	18
13 30 00 36	19
13 30 00 37	20
13 30 00 38	21
13 30 00 39	22
13 30 00 40	23
13 30 00 41	24
13 30 00 42	27
13 30 00 43	30
13 30 00 44	32

FLEXIBLE GEAR WRENCH SET

- ▶ #40 chrome steel, #50 chrome vanadium steel gear
- ▶ 72 teeth
- ▶ Fully polished satin chrome plated/mirror polished chrome plated, plastic holder packing



Item no.	Contents
13 90 30 18	5PCS Size: 8-10-12-13-14mm
13 90 30 19	6PCS Size: 8-10-12-13-14-17mm
13 90 30 20	8PCS Size: 8-10-11-12-14-16-17-19mm
13 90 30 21	12PCS Size: 8-9-10-11-12-13-14-15-16-17-18-19mm



WRENCHES AND SPANNERS

GEAR WRENCH SET

- ▶ #40 chrome steel,#50 chrome vanadium steel gear
- ▶ 72 teeth
- ▶ Fully polished satin chrome plated/mirror polished chrome plated, plastic holder packing



Item no.	Contents
13 90 30 22	5PCS Size: 8-10-12-13-14mm
13 90 30 23	7PCS Size: 8-10-12-13-14-17-19mm

FLEXIBLE GEAR WRENCH SET

- ▶ #40 chrome steel,#50 chrome vanadium steel gear
- ▶ 72 teeth
- ▶ Fully polished satin chrome plated/mirror polished chrome plated, plastic holder packing



Item no.	Contents
13 90 30 24	5PCS Size: 8-10-12-13-14mm
13 90 30 25	7PCS Size: 8-10-12-13-14-17-19mm

5PCS GEAR WRENCH SET

- ▶ Drop forged carbon steel body, mirror polished, chrome plated, alloy steel ratchet, hardened for high torque
- ▶ 72teeth for ratchet gear, fast tightening and high torque transfer
- ▶ Packed in plastic case



Item no.	Contents
13 90 30 26	10,12,13,14,17mm

5PCS FLEXIBLE GEAR WRENCH SET

- ▶ Drop forged carbon steel body, mirror polished, chrome plated, alloy steel ratchet, hardened for high torque
- ▶ 72teeth for ratchet gear & flexible head, fast tightening and high torque transfer
- ▶ Packed in plastic case



Item no.	Contents
13 90 30 27	10,12,13,14,17mm

7PCS GEAR WRENCH SET

- ▶ #40 chrome steel, #50 chrome vanadium steel gear
- ▶ 72 teeth
- ▶ Fully polished satin chrome plated/mirror polished chrome plated, canvas bag packing



Item no.	Contents
13 90 30 28	8-10-12-13-14-15-18mm

8PCS GEAR WRENCH SET

- ▶ Cr-V steel material with heat treatment
- ▶ 72 teeth
- ▶ Fully polished and Chrome plated/ Mirror polished
- ▶ Packed in plastic tray with holder & tie.



Item no.	Contents
13 90 30 29	Metric: 8mm,10mm,12mm,13mm,14mm,16mm,17mm,19mm, SAE: 5/16",3/8",7/15",1/2",9/16",5/8",11/16",3/4",2

7PCS GEAR WRENCH SET

- ▶ #40 chrome steel
- ▶ #50 chrome vanadium steel gear
- ▶ 72 teeth
- ▶ Fully polished satin chrome plated/mirror polished chrome plated



Item no.	Contents
13 90 30 30	8-10-12-13-14-17-19mm

12PCS GEAR WRENCH SET

- ▶ Blow mould case packing
- ▶ Professional quality
- ▶ Drop forged tool steel, fully polished and chrome plated panel
- ▶ Gear hardened and black finished



Item no.	Contents
13 90 30 31	8-10-12-13-17-19mm gear wrench Adaptor(hexagon to square) 10mm-1/4",13mm-3/8",19mm-1/2" Adaptor(Square to Hexagon) 1/4"-1/4",-3/8"-5/16",1/2"-10MM

10PCS GEAR WRENCH SET

- ▶ Professional quality
- ▶ Drop forged tool steel, fully polished and chrome plated panel
- ▶ Gear hardened and black finished
- ▶ with 45 teeth for improving working efficiency
- ▶ With 4pcs adaptors
- ▶ Packed in blow mould case



Item no.	Contents
13 90 30 34	8-10-13-14-17-19mm

10PCS FLEXSBILE GEAR WRENCH SET

- ▶ Drop forged carbon steel body, fully polished and chrome plated panel.
- ▶ Alloy steel ratchet, hardeed for high torque
- ▶ Flexible head for more convenient working and will be improve the working efficiency highly.
- ▶ The ideal wrench for getting into different spaces
- ▶ With 4pcs adaptors
- ▶ Packed in blow mould case



Item no.	Contents
13 90 30 35	8-10-13-14-17-19mm

6PCS GEAR WRENCH SET

- ▶ Drop forged carbon steel body, fully polished and chrome plated panel.
- ▶ Alloy steel ratchet, hardened for high torque
- ▶ Flexible head for more convenient working and will be improve the working efficiency highly.
- ▶ The ideal wrench for getting into different spaces
- ▶ Packed in metal box



Item no.	Contents
13 90 30 38	8mm, 10mm, 13mm, 14mm, 17mm, 19mm

5PCS ULTRA-SHORT GEAR WRENCH

- ▶ Polished, with 45 teeth, body made of carbon steel and teeth made of 40Cr, chrome plated
- ▶ Packed on plastic holder



Item no.	Contents
13 90 30 41	10-12-13-17-19mm

13PCS FLEXIBLE GEAR WRENCH SET

- ▶ #40 chrome steel
- ▶ #50 chrome vanadium steel gear
- ▶ 72 teeth
- ▶ Fully polished satin chrome plated/mirror polished chrome plated



Item no.	Contents
13 90 30 36	8-10-12-13-14-17-19-21-22-24-27-30-32mm

6PCS FLEXIBLE GEAR WRENCH SET

- ▶ Drop forged carbon steel body, mirror polished, chrome plated, alloy steel ratchet, hardened for high torque
- ▶ 72teeth for ratchet gear, fast tightening and high torque transfer



Item no.	Contents
13 90 30 39	8,10,13,14,17,19mm

5PCS ULTRA-SHORT FLEXIBLE GEAR WRENCH SET

- ▶ #40 chrome steel,#50 chrome vanadium steel gear
- ▶ 72 teeth,fully polished satin



Item no.	Contents
13 90 30 42	8-10-13-14-17mm

13PCS FLEXIBLE GEAR WRENCH SET

- ▶ #40 chrome steel,#50 chrome vanadium steel gear
- ▶ 72 teeth
- ▶ Fully polished satin chrome plated/mirror polished chrome plated



Item no.	Contents
13 90 30 37	8-10-12-13-15-16-17-19-22-24MM 3pcs adapter 1/4", 3/8", 1/2"

12PCS ULTRA-SHORT GEAR WRENCH

- ▶ #40 chrome steel,#50 chrome vanadium steel gear,72 teeth,fully polished satin chrome plated/mirror polished chrome plated



Item no.	Contents
13 90 30 40	8-9-10-11-12-13-14-15-16-17-18-19mm



6 PIECES RATCHET SPANNER SET

- ▶ Forged carbon steel shaft, Cr-v steel gear part with heat treatment
- ▶ Polished and chrome plated in metal clip



Item no.	Contents
13 90 20 30	10x11 12x13 14x15 16x17 18x19 20x22MM



WRENCHES AND SPANNERS

5PCS RATCHET RING SPANNER SET

- ▶ Carbon steel gear, forged and hardened, middle carbon steel plate shaft
- ▶ ABS enclosure
- ▶ Packed in blow mould case



Item no.	Contents
13 90 20 31	1/4X5/16, 3/8X7/16, 1/2X9/16 5/8X11/16, 3/4X7/8
13 90 20 32	6X8, 10X12, 11X13 14X17, 19X21mm

5PCS RATCHET SPANNER SET

- ▶ reversible ratchet ring head in each end
- ▶ Chrome plated
- ▶ In plastic holder



Item no.	Contents
13 90 20 33	6X8, 10X12, 11X13 14X17, 19X21mm

RATCHET SPANNER SET

- ▶ Reversible
- ▶ Chrome-plated
- ▶ With plastic surround
- ▶ 25 degree head for easy using
- ▶ Packed in double blister



Item no.	Contents
13 90 20 34	3PCS Size:10x12 11x13 14x17MM
13 90 20 35	5PCS Size:6x8 10x12 11x13 14x17 19x21MM

5PCS RATCHET SPANNER SET

- ▶ Reversible
- ▶ Chrome-plated
- ▶ With plastic surround
- ▶ 25 degree head for easy using
- ▶ Packed in double blister



Item no.	Contents
13 90 20 36	3PCS Size:10x12 11x13 14x17MM
13 90 20 37	5PCS Size:6x8 10x12 11x13 14x17 19x21MM

STRAIGHT TAIL GEAR SOCKET WR

- ▶ Professional quality
- ▶ Drop forged tool steel
- ▶ Fine sand blasting and black finished
- ▶ Gear reversible, hardened



Item no.	Contents
13 30 30 45	10x12mm-12x14mm-13x17mm 14x17mm-17x19mm-19x21mm

BENT TAIL GEAR SOCKET WRENCH

- ▶ Professional quality
- ▶ Drop forged tool steel
- ▶ Fine sand blasting and chrome plated
- ▶ Gear reversible, hardened



Item no.	Contents
13 30 30 46	10x12mm-12x14mm-13x17mm 14x17mm-17x19mm-19x21mm

OPEN END SLOGGING WRENCH

- ▶ Forged #50 chrome vanadium steel, hardened
- ▶ Sand blasting and black finish



Item no.	Contents
13 10 00 01	24
13 10 00 02	27
13 10 00 03	30
13 10 00 04	32
13 10 00 05	36
13 10 00 06	41
13 10 00 07	46
13 10 00 08	50
13 10 00 09	55
13 10 00 10	60
13 10 00 11	65
13 10 00 12	70
13 10 00 13	75

RING SLOGGING WRENCH

- ▶ Forged #50 chrome vanadium steel, hardened, sand blasting and black finish



Item no.	Contents
13 10 40 01	24
13 10 40 02	27
13 10 40 03	30
13 10 40 04	32
13 10 40 05	36
13 10 40 06	41
13 10 40 07	46
13 10 40 08	50
13 10 40 09	55
13 10 40 10	60
13 10 40 11	65
13 10 40 12	70
13 10 40 13	75

OPEN END SPANNER

- ▶ Forged carbon steel, heat treatment, black finish



Item no.	Contents
13 10 00 14	10
13 10 00 15	12
13 10 00 16	13
13 10 00 17	14
13 10 00 18	17
13 10 00 19	19
13 10 00 20	22
13 10 00 21	24
13 10 00 22	26
13 10 00 23	27
13 10 00 24	30
13 10 00 25	32
13 10 00 26	35
13 10 00 27	36
13 10 00 28	38
13 10 00 29	41
13 10 00 30	46
13 10 00 31	50
13 10 00 32	55
13 10 00 33	60
13 10 00 34	65
13 10 00 35	70
13 10 00 36	75



TUBULAR BOX SPANNER

- ▶ Carbon steel tube with chrome plated
- ▶ Punched round hole
- ▶ Sliding card packing/In PVC pouch

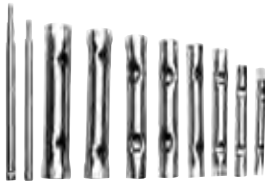

Item no.	Contents
13 90 00 01	6PCS Size: 8X9,10X11,12X13,14X15,16X17MM
13 90 00 02	10PCS Size: 6X7,8X9,10X11,12X13,14X15,16X17, 18X19,20X22MM

TUBULAR SOCKET WRENCH

- ▶ Made of #40 Cr-v steel
- ▶ Dropped forged and heat treatment
- ▶ fully polished chrome plated



Item no.	Contents
13 20 40 13	6x7
13 20 40 14	8x9
13 20 40 15	10x11
13 20 40 16	12x13
13 20 40 17	14x15
13 20 40 18	16x17
13 20 40 19	18x19
13 20 40 20	20x22
13 20 40 21	21x23
13 20 40 22	24x26
13 20 40 23	25x28
13 20 40 24	30x32

SPARK PLUG WRENCH

- ▶ Cast iron, fully polished chrome plated
- ▶ With T-handle
- ▶ PVC dipped covered
- ▶ With/without spring



Item no.	Contents
13 10 40 14	16mm
13 10 40 15	20.8mm
13 10 40 16	16-20.8mm

LONG T-TYPE WRENCH

- ▶ Made of carbon steel
- ▶ Dropped forged and heat treatment
- ▶ Socket fully polished
- ▶ Handle sand blasting chrome plated



Item no.	Contents
13 10 40 17	16mm
13 10 40 18	20.8mm

FOLDING 4-WAY RIM WRENCH

- ▶ Made of carbon steel
- ▶ Drop forged with heat treatment
- ▶ Fully polished chrome plated



Item no.	Contents
13 50 00 01	7"
13 50 00 02	14"

CROSS RIM WRENCH

- ▶ Forged carbon steel, heat treatment, fully polished, silver lacquer finish, GS certificate



Item no.	Contents
13 50 00 03	14"
13 50 00 04	15"
13 50 00 05	20"

CROSS RIM WRENCH WITH IRON PAD

- ▶ Forged carbon steel, heat treatment, fully polished, chrome plated



Item no.	Contents
13 50 00 06	14"
13 50 00 07	15"
13 50 00 08	20"
13 50 00 09	30"

CROSS RIM WRENCH WITH DIPPED HANDLE

- ▶ Forged carbon steel, heat treatment, fully polished, 3 socket bits + 1 socket holder, dipped handle



Item no.	Contents
13 50 00 06	14"

Y-TYPE WRENCH

- ▶ Made of carbon steel
- ▶ Dropped forged and heat treatment
- ▶ Socket fully polished
- ▶ Handle sand blasting chrome plated



Item no.	Contents
13 50 40 01	8x9x10
13 50 40 02	9x11x13
13 50 40 03	10x12x14
13 50 40 04	10x14x17
13 50 40 05	12x14x17



WRENCHES AND SPANNERS

EXTENDABLE LUG WRENCH

- ▶ 1/2" square driver with rubber grip adjustable 350mm to 550mm reversible socket 17 x 19 mm



Item no.	Contents
13 90 20 31	(17x19)x350-550

L-TYPE WRENCH WITH HOLE

- ▶ Forged carbon steel
- ▶ Chrome-plated



Item no.	Contents
13 50 20 02	6
13 50 20 03	7
13 50 20 04	8
13 50 20 05	9
13 50 20 06	10
13 50 20 07	11
13 50 20 08	12
13 50 20 09	13
13 50 20 10	14
13 50 20 11	15
13 50 20 12	16
13 50 20 13	17
13 50 20 14	18
13 50 20 15	19
13 50 20 16	20
13 50 20 17	21
13 50 20 18	22
13 50 20 19	23
13 50 20 20	24
13 50 20 21	25
13 50 20 22	26
13 50 20 23	27
13 50 20 24	30
13 50 20 25	34
13 50 20 26	36

L-TYPE WRENCH WITH CROWBAR

- ▶ Made of carbon steel
- ▶ Dropped forged and heat treatment
- ▶ Socket fully polished
- ▶ Handle sand blasting chrome plated



Item no.	Contents
13 50 20 27	14 mm
13 50 20 28	17 mm
13 50 20 29	19 mm
13 50 20 30	21 mm
13 50 20 31	22 mm
13 50 20 32	23 mm
13 50 20 33	24 mm
13 50 20 34	26 mm
13 50 20 35	27 mm

S TYPE DOUBLE RING SPANNER

- ▶ Drop forged carbon steel/chrome vanadium steel
- ▶ Sand blasting and chrome plated
- ▶ 45#/Cr-V



Item no.	Contents
13 90 50 01	10x11-12x13-14x15-16x17-18x19mm

U TYPE DOUBLE RING SPANNER

- ▶ Drop forged carbon steel/chrome vanadium steel
- ▶ Sand blasting and chrome plated



Item no.	Contents
13 90 50 02	8x10 11x13 14x15 17x19 21x22mm

QUICK WRENCH

- ▶ Chrome vanadium steel jaws, heat treatment, carbon steel body, black finish, 2 color dipped handle, adjustable size jaws



Item no.	Contents
13 99 00 01	Max work size: 21mm

ADJUSTABLE AUTO WRENCH

- ▶ Forged carbon steel
- ▶ Chrome-plated



Item no.	Contents
13 99 00 01	230MM/280MM/375MM



HAMMERS AND HATCHET

MACHINIST'S HAMMER, DIN 1041

- ▶ Forged carbon steel
- ▶ Fine wooden handle



Item no.	Contents
15 20 00 01	100 g
15 20 00 02	200 g
15 20 00 03	300 g
15 20 00 04	400 g
15 20 00 05	500 g
15 20 00 06	600 g
15 20 00 07	800 g
15 20 00 08	1000 g
15 20 00 09	1500 g
15 20 00 10	2000 g

MACHINIST'S HAMMER, DIN 1041

- ▶ Forged carbon steel
- ▶ Bleached handle with metal protection



Item no.	Contents
15 20 40 21	100 g
15 20 40 22	200 g
15 20 40 23	300 g
15 20 40 24	400 g
15 20 40 25	500 g
15 20 40 26	600 g
15 20 40 27	800 g
15 20 40 28	1000 g

MACHINIST'S HAMMER, DIN 1041

- ▶ Forged carbon steel
- ▶ Fiberglass handle



Item no.	Contents
15 20 20 01	100 g
15 20 20 02	200 g
15 20 20 03	300 g
15 20 20 04	400 g
15 20 20 05	500 g
15 20 20 06	600 g
15 20 20 07	800 g
15 20 20 08	1000 g
15 20 20 09	1500 g
15 20 20 10	2000 g

MACHINIST'S HAMMER, DIN 1041

- ▶ Forged carbon steel
- ▶ Wooden handle



Item no.	Contents
15 20 00 11	100 g
15 20 00 12	200 g
15 20 00 13	300 g
15 20 00 14	400 g
15 20 00 15	500 g
15 20 00 16	600 g
15 20 00 17	800 g
15 20 00 18	1000 g
15 20 00 19	1500 g
15 20 00 20	2000 g

MACHINIST'S HAMMER, DIN 1041

- ▶ Forged carbon steel
- ▶ Tubular steel handle



Item no.	Contents
15 20 40 01	100 g
15 20 40 02	200 g
15 20 40 03	300 g
15 20 40 04	400 g
15 20 40 05	500 g
15 20 40 06	600 g
15 20 40 07	800 g
15 20 40 08	1000 g

MACHINIST'S HAMMER, DIN 1041

- ▶ Forged Carbon Steel
- ▶ Fiberglass Handle
- ▶ Plastic coated
- ▶ With 2 components soft handle.



Item no.	Contents
15 20 20 11	100 g
15 20 20 12	200 g
15 20 20 13	300 g
15 20 20 14	400 g
15 20 20 15	500 g
15 20 20 16	600 g
15 20 20 17	800 g
15 20 20 18	1000 g
15 20 20 19	1500 g
15 20 20 20	2000 g

MACHINIST'S HAMMER, GERMANY TYPE

- ▶ Forged carbon steel
- ▶ Tubular handle
- ▶ With two components TPR soft grip



Item no.	Contents
15 20 40 09	300 g
15 20 40 10	500 g

MACHINIST'S HAMMER, GERMANY TYPE

- ▶ Forged carbon steel
- ▶ Fiberglass handle
- ▶ Anti-slip comfortable TPR coated
- ▶ 2 components soft handle



Item no.	Contents
15 20 20 21	100 g
15 20 20 22	200 g
15 20 20 23	300 g
15 20 20 24	400 g
15 20 20 25	500 g
15 20 20 26	600 g

MACHINIST'S HAMMER HEAD

- ▶ Forged carbon steel



Item no.	Contents
15 99 00 01	100 g
15 99 00 02	200 g
15 99 00 03	300 g
15 99 00 04	400 g
15 99 00 05	500 g
15 99 00 06	600 g
15 99 00 07	800 g
15 99 00 08	1000 g
15 99 00 09	1500 g
15 99 00 10	2000 g

STONING HAMMER, DIN 6475

- ▶ Forged carbon steel
- ▶ Wooden handle



Item no.	Contents
15 40 00 06	800 g
15 40 00 07	1000 g
15 40 00 08	1250 g
15 40 00 09	1500 g
15 40 00 10	2000 g

MACHINIST'S HAMMER, FRENCH TYPE

- ▶ Forged carbon steel
- ▶ Wooden handle



Item no.	Contents
15 20 00 29	20 mm
15 20 00 30	25 mm
15 20 00 31	28 mm
15 20 00 32	30 mm
15 20 00 33	35 mm
15 20 00 34	40 mm
15 20 00 35	45 mm

SPALLING HAMMER HEAD

- ▶ Forged carbon steel



Item no.	Contents
15 99 00 11	3 kg
15 99 00 12	4 kg
15 99 00 13	5 kg
15 99 00 14	6 kg
15 99 00 15	8 kg
15 99 00 16	10 kg

STONING HAMMER, DIN 6475

- ▶ Forged carbon steel
- ▶ Bleached handle with metal protection



Item no.	Contents
15 40 00 11	1000 g
15 40 00 12	1250 g
15 40 00 13	1500 g
15 40 00 14	2000 g

MACHINIST'S HAMMER, FRENCH TYPE

- ▶ Forged carbon steel
- ▶ Fiberglass Handle
- ▶ Plastic coated



Item no.	Contents
15 20 20 27	20 mm
15 20 20 28	25 mm
15 20 20 29	28 mm
15 20 20 30	30 mm
15 20 20 31	35 mm
15 20 20 32	40 mm
15 20 20 33	45 mm

STONING HAMMER, DIN 6475

- ▶ Forged carbon steel
- ▶ Fine hickory wooden handle



Item no.	Contents
15 40 00 01	800 g
15 40 00 02	1000 g
15 40 00 03	1250 g
15 40 00 04	1500 g
15 40 00 05	2000 g

STONING HAMMER, DIN 6475

- ▶ Forged carbon steel
- ▶ Tubular steel handle



Item no.	Contents
15 40 40 01	1000 g
15 40 40 02	1250 g
15 40 40 03	1500 g
15 40 40 04	2000 g

STONING HAMMER, GERMANY TYPE

- ▶ Forged carbon steel
- ▶ Tubular handle
- ▶ With two components TPR soft grip

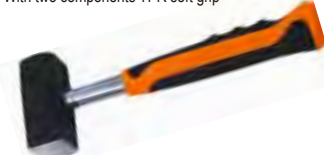

Item no.	Contents
15 40 40 05	1000 g



HAMMERS AND HATCHET



STONING HAMMER, DIN 6475

- ▶ Forged carbon steel
- ▶ Fiberglass handle, plastic coated
- ▶ With 2 components soft handle



Item no. Contents

15 40 20 05	1000 g
15 40 20 06	1250 g
15 40 20 07	1500 g
15 40 20 08	2000 g

STONING HAMMER, AMERICAN TYPE

- ▶ Forged carbon steel
- ▶ Fiberglass handle, plastic coated
- ▶ With soft rubber grip



Item no. Contents

15 40 20 12	2 LB
15 40 20 13	2.5 LB
15 40 20 14	3 LB
15 40 20 15	4 LB

STONING HAMMER, SPANISH TYPE

- ▶ Forged carbon steel
- ▶ Wooden handle



Item no. Contents

15 40 00 23	1 kg
15 40 00 24	1.25 kg
15 40 00 25	1.5 kg
15 40 00 26	2 kg

STONING HAMMER, GERMANY TYPE

- ▶ Forged carbon steel
- ▶ Fiberglass handle, anti-slip comfortable TPR coated
- ▶ 2 components soft handle



Item no. Contents

15 40 20 09	800 g
15 40 20 10	1000 g
15 40 20 11	1500 g

STONING HAMMER, FRENCH TYPE

- ▶ Forged carbon steel
- ▶ Wooden handle



Item no. Contents

15 40 00 19	1 kg
15 40 00 20	1.25 kg
15 40 00 21	1.5 kg
15 40 00 22	2 kg

JOINER'S HAMMER, FRENCH TYPE

- ▶ Forged carbon steel
- ▶ Wooden handle



Item no. Contents

15 30 20 01	20 mm
15 30 20 02	22 mm
15 30 20 03	25 mm
15 30 20 04	28 mm
15 30 20 05	30 mm

STONING HAMMER, AMERICAN TYPE

- ▶ Forged carbon steel
- ▶ Wooden handle



Item no. Contents

15 40 00 15	2 LB
15 40 00 16	2.5 LB
15 40 00 17	3 LB
15 40 00 18	4 LB

STONING HAMMER, SPANISH TYPE

- ▶ Forged carbon steel
- ▶ Fiberglass handle, anti-slip comfortable TPR coated
- ▶ 2 components soft handle



Item no. Contents

15 40 20 16	1 kg
15 40 20 17	1.25 kg
15 40 20 18	1.5 kg
15 40 20 19	2 kg

JOINER'S HAMMER, FRENCH TYPE

- ▶ Forged carbon steel
- ▶ Fiberglass handle
- ▶ Plastic coated
- ▶ 2 components soft handle



Item no. Contents

15 30 20 06	20 mm
15 30 20 07	22 mm
15 30 20 08	25 mm
15 30 20 09	28 mm
15 30 20 10	30 mm

JOINER'S HAMMER, FRENCH TYPE

- ▶ Forged carbon steel
- ▶ Fiberglass handle
- ▶ Anti-slip comfortable TPR coated
- ▶ 2 components soft handle



Item no.	Contents
15 30 00 01	20 mm
15 30 00 02	22 mm
15 30 00 03	25 mm
15 30 00 04	28 mm
15 30 00 05	30 mm

BRICK HAMMER

- ▶ Forged carbon steel
- ▶ Head polished
- ▶ Fine wooden handle



Item no.	Contents
15 50 20 01	24 OZ

BRICK HAMMER

- ▶ Forged carbon steel
- ▶ Head polished
- ▶ Fiberglass handle
- ▶ Plastic coated
- ▶ Soft grip



Item no.	Contents
15 50 20 01	600 g
15 50 20 02	16 OZ
15 50 20 03	20 OZ
15 50 20 04	24 OZ

BRICKLAYER'S HAMMER, BERLIN PATTERN

- ▶ Forged carbon steel
- ▶ With tubular steel handle
- ▶ Black lacquered head



Item no.	Contents
15 50 40 01	600 g

BRICKLAYER'S HAMMER, BERLIN PATTERN

- ▶ Forged carbon steel
- ▶ With tubular steel handle
- ▶ Black lacquered head



Item no.	Contents
15 50 40 02	600 g

MULTI-PURPOSE HATCHET

- ▶ Forged carbon steel
- ▶ Tubular steel handle
- ▶ Black lacquered head



Item no.	Contents
15 99 00 18	600 g

ROOFING HAMMER

- ▶ Forged carbon steel
- ▶ Head polished
- ▶ Fine wooden handle



Item no.	Contents
15 55 00 01	600 g



ROOFING HAMMER

- ▶ Forged carbon steel
- ▶ With tubular steel handle
- ▶ Black lacquered head



Item no.	Contents
15 55 40 01	600 g

ROOFING HAMMER

- ▶ Forged carbon steel
- ▶ Fiberglass handle



Item no.	Contents
15 55 20 01	600 g

ROOFING HAMMER

- ▶ Forged carbon steel
- ▶ Fiberglass handle
- ▶ Plastic coated
- ▶ 2 components soft handle



Item no.	Contents
15 55 20 02	600 g

CLAW HAMMER, AMERICAN TYPE

- ▶ Forged carbon steel
- ▶ Ground and fully polished
- ▶ With fine wooden handle



Item no.	Contents
15 60 00 01	8 OZ
15 60 00 02	12 OZ
15 60 00 03	16 OZ
15 60 00 04	20 OZ
15 60 00 05	24 OZ



HAMMERS AND HATCHET

CLAW HAMMER, AMERICAN TYPE

- ▶ Forged carbon steel
- ▶ Ground and fully polished
- ▶ With fine wooden handle



Item no.	Contents
15 60 00 06	8 OZ
15 60 00 07	12 OZ
15 60 00 08	16 OZ
15 60 00 09	20 OZ
15 60 00 10	24 OZ

CLAW HAMMER, AMERICAN TYPE

- ▶ Forged carbon steel
- ▶ Ground and fully polished
- ▶ With fine wooden handle



Item no.	Contents
15 60 00 11	8 OZ
15 60 00 12	12 OZ
15 60 00 13	16 OZ
15 60 00 14	20 OZ
15 60 00 15	24 OZ

CLAW HAMMER, AMERICAN TYPE

- ▶ Forged carbon steel
- ▶ Ground and fully polished
- ▶ With fine Hickory wooden handle



Item no.	Contents
15 60 00 16	8 OZ
15 60 00 17	12 OZ
15 60 00 18	16 OZ
15 60 00 19	20 OZ
15 60 00 20	24 OZ

CLAW HAMMER, AMERICAN TYPE

- ▶ Forged carbon steel
- ▶ Ground and polished
- ▶ Fiberglass handle
- ▶ With soft grip



Item no.	Contents
15 60 20 01	8 OZ
15 60 20 02	12 OZ
15 60 20 03	16 OZ
15 60 20 04	20 OZ
15 60 20 05	24 OZ

CLAW HAMMER

- ▶ Forged carbon steel
- ▶ Fiberglass handle, anti-slip comfortable TPR coated
- ▶ 2 components soft handle



Item no.	Contents
15 60 20 06	8 OZ
15 60 20 07	16 OZ
15 60 20 08	20 OZ

CLAW HAMMER, AMERICAN TYPE

- ▶ Forged carbon steel
- ▶ Ground and polished
- ▶ Fiberglass handle, Plastic coated
- ▶ With 2 components soft handle



Item no.	Contents
15 60 20 09	8 OZ
15 60 20 10	12 OZ
15 60 20 11	16 OZ
15 60 20 12	20 OZ
15 60 20 13	24 OZ

CLAW HAMMER

- ▶ Forged carbon steel
- ▶ Tubular handle
- ▶ With two components TPR soft grip



Item no.	Contents
15 60 40 01	8 OZ
15 60 40 02	16 OZ
15 60 40 03	20 OZ

CLAW HAMMER

- ▶ Forged carbon steel
- ▶ Ground and polished
- ▶ With tubular handle
- ▶ With soft grip



Item no.	Contents
15 60 40 04	8 OZ
15 60 40 05	12 OZ
15 60 40 06	16 OZ
15 60 40 07	20 OZ
15 60 40 08	24 OZ

CLAW HAMMER, CALIFORNIA TYPE

- ▶ Forged carbon steel
- ▶ Milled face
- ▶ With fine Hickory wooden handle



Item no.	Contents
15 60 00 31	20 OZ
15 60 00 32	25 OZ

CLAW HAMMER, BRITISH TYPE

- ▶ Forged carbon steel
- ▶ Ground and polished
- ▶ With wooden handle



Item no.	Contents
15 60 00 38	21 mm
15 60 00 39	23 mm
15 60 00 40	25 mm
15 60 00 41	27 mm
15 60 00 42	29 mm

CLAW HAMMER, BRITISH TYPE

- ▶ Forged carbon steel
- ▶ Ground and polished
- ▶ With fiberglass handle
- ▶ With soft grip



Item no.	Contents
15 60 20 19	21 mm
15 60 20 20	23 mm
15 60 20 21	25 mm
15 60 20 22	27 mm
15 60 20 23	29 mm

CLAW HAMMER, BRITISH TYPE

- ▶ Forged carbon steel
- ▶ Ground and polished
- ▶ With fiberglass handle
- ▶ With soft grip



Item no. Contents

15 60 20 24	21 mm
15 60 20 25	23 mm
15 60 20 26	25 mm
15 60 20 27	27 mm
15 60 20 28	29 mm

ITALY STYLE HAMMER

- ▶ Forged carbon steel
- ▶ With fiberglass handle
- ▶ Plastic coated
- ▶ With two components TPR soft grip



Item no. Contents

15 60 20 36	0.25 kg
15 60 20 37	0.3 kg
15 60 20 38	0.4 kg
15 60 20 39	0.5 kg

SLEDGE HAMMER

- ▶ Forged carbon steel
- ▶ Fiberglass handle
- ▶ Plastic coated



Item no. Contents

15 70 00 11	6 LB
15 70 00 12	8 LB
15 70 00 13	10 LB
15 70 00 14	12 LB
15 70 00 15	14 LB
15 70 00 16	16 LB
15 70 00 17	18 LB
15 70 00 18	20 LB

CLAW HAMMER

- ▶ Forged carbon steel
- ▶ Fiberglass handle
- ▶ Anti-slip comfortable TPR coated
- ▶ 2 components soft handle



Item no. Contents

15 60 20 29	23 mm
15 60 20 30	25 mm
15 60 20 31	27 mm

SPANISH STYLE HAMMER

- ▶ Forged carbon steel
- ▶ With wooden handle



Item no. Contents

15 60 00 47	0.6 kg
15 60 00 48	0.7 kg

CROSS PEIN SLEDGE HAMMER, AMERICAN TYPE

- ▶ Forged carbon steel
- ▶ With wooden handle



Item no. Contents

15 70 00 19	3 LB
15 70 00 20	4 LB

CLAW HAMMER

- ▶ Forged carbon steel
- ▶ Tubular handle
- ▶ With two components TPR soft grip



Item no. Contents

15 60 40 09	23 mm
15 60 40 10	25 mm
15 60 40 11	27 mm

SLEDGE HAMMER

- ▶ Forged carbon steel
- ▶ With bleached handle



Item no. Contents

15 70 00 01	2 LB
15 70 00 02	2.5 LB
15 70 00 03	3 LB
15 70 00 04	4 LB
15 70 00 05	5 LB

CROSS PEIN SLEDGE HAMMER, AMERICAN TYPE

- ▶ Forged carbon steel
- ▶ With fiberglass handle
- ▶ With soft handle



Item no. Contents

15 70 00 21	3 LB
15 70 00 22	4 LB

ITALY STYLE HAMMER

- ▶ Forged carbon steel
- ▶ With wooden handle



Item no. Contents

15 60 00 43	0.25 kg
15 60 00 44	0.3 kg
15 60 00 45	0.4 kg
15 60 00 46	0.5 kg

SLEDGE HAMMER

- ▶ Forged carbon steel
- ▶ Fiberglass handle



Item no. Contents

15 70 00 06	2 LB
15 70 00 07	2.5 LB
15 70 00 08	3 LB
15 70 00 09	4 LB
15 70 00 10	5 LB





OCTAGONAL HAMMER, JAPANESE TYPE

- ▶ Forged carbon steel
- ▶ Fully polished
- ▶ With fiberglass handle
- ▶ With soft handle



Item no.	Contents
15 70 00 23	450 g
15 70 00 24	900 g
15 70 00 25	1100 g
15 70 00 26	1300 g
15 70 00 27	1500 g

BALL PEIN HAMMER

- ▶ Forged carbon steel
- ▶ Polished head
- ▶ With fine hickory wooden handle



Item no.	Contents
15 70 20 05	12 OZ
15 70 20 06	16 OZ
15 70 20 07	24 OZ
15 70 20 08	32 OZ

BRASS HAMMER RED COPPER HAMMER

- ▶ Head material: red copper or brass
- ▶ With fine hickory wooden handle



Item no.	Contents
15 80 20 01	16 OZ
15 80 20 02	24 OZ
15 80 20 03	32 OZ
15 80 20 04	40 OZ
15 80 20 05	48 OZ
15 80 20 06	64 OZ
15 80 20 07	80 OZ

SLEDGE HAMMER HEAD

- ▶ Forged carbon steel
- ▶ Black lacquered



Item no.	Contents
15 99 00 19	2 LB
15 99 00 20	2.5 LB
15 99 00 21	4 LB
15 99 00 22	6 LB
15 99 00 23	8 LB
15 99 00 24	10 LB
15 99 00 25	12 LB
15 99 00 26	14 LB
15 99 00 27	16 LB
15 99 00 28	18 LB
15 99 00 29	20 LB

BALL PEIN HAMMER

- ▶ Forged carbon steel
- ▶ Polished head
- ▶ With fiberglass handle
- ▶ With soft grip



Item no.	Contents
15 70 20 09	12 OZ
15 70 20 10	16 OZ
15 70 20 11	24 OZ
15 70 20 12	32 OZ

BRASS HAMMER RED COPPER HAMMER

- ▶ Head material: red copper or brass
- ▶ With wooden handle



Item no.	Contents
15 80 20 08	16 OZ
15 80 20 09	24 OZ
15 80 20 10	32 OZ
15 80 20 11	40 OZ
15 80 20 12	48 OZ
15 80 20 13	64 OZ
15 80 20 14	80 OZ

BALL PEIN HAMMER

- ▶ Forged carbon steel
- ▶ Fully mirror polished head
- ▶ Fine wooden handle



Item no.	Contents
15 70 20 01	12 OZ
15 70 20 02	16 OZ
15 70 20 03	24 OZ
15 70 20 04	32 OZ

BALL PEIN HAMMER

- ▶ Forged carbon steel
- ▶ Fiberglass handle, anti-slip comfortable TPR coated
- ▶ 2 components soft handle



Item no.	Contents
15 70 20 13	8 OZ
15 70 20 14	16 OZ
15 70 20 15	20 OZ

RUBBER MALLET

- ▶ Rubber head
- ▶ With wooden handle



Item no.	Contents
15 80 40 01	8 OZ
15 80 40 02	12 OZ
15 80 40 03	16 OZ
15 80 40 04	20 OZ
15 80 40 05	24 OZ
15 80 40 06	32 OZ

BALL PEIN HAMMER

- ▶ Forged carbon steel
- ▶ Polished head
- ▶ With tubular handle
- ▶ With soft grip



Item no.	Contents
15 70 20 16	12 OZ
15 70 20 17	16 OZ
15 70 20 18	24 OZ
15 70 20 19	32 OZ

RUBBER MALLET, FRENCH TYPE

- ▶ Rubber head
- ▶ With wooden handle



Item no. Contents

15 80 40 07	8 OZ
15 80 40 08	12 OZ
15 80 40 09	16 OZ
15 80 40 10	20 OZ
15 80 40 11	24 OZ
15 80 40 12	32 OZ

RUBBER MALLET

- ▶ Rubber head
- ▶ With tubular handle
- ▶ With soft grip



Item no. Contents

15 80 40 25	8 OZ
15 80 40 26	12 OZ
15 80 40 27	16 OZ
15 80 40 28	20 OZ
15 80 40 29	24 OZ
15 80 40 30	32 OZ

DEAD BLOW RUBBER MALLET

- ▶ Rubbers head for heavy and effective blows
- ▶ With tubular handle
- ▶ With soft grip



Item no. Contents

15 80 40 41	1.0 LB
15 80 40 42	1.5 LB
15 80 40 43	2.0 LB
15 80 40 44	3.0 LB
15 80 40 45	4.0 LB

RUBBER MALLET

- ▶ Rubber head
- ▶ With tubular handle
- ▶ With soft grip



Item no. Contents

15 80 40 13	8 OZ
15 80 40 14	12 OZ
15 80 40 15	16 OZ
15 80 40 16	20 OZ
15 80 40 17	24 OZ
15 80 40 18	32 OZ

DEAD BLOW RUBBER MALLET

- ▶ Rubbers head for heavy and effective blows



Item no. Contents

15 80 40 31	1.0 LB
15 80 40 32	1.5 LB
15 80 40 33	2.0 LB
15 80 40 34	3.0 LB
15 80 40 35	4.0 LB

TWO WAY MALLET

- ▶ Replaceable rubber/nylon head
- ▶ With tubular handle
- ▶ With soft grip



Item no. Contents

15 80 40 46	20 mm
15 80 40 47	25 mm
15 80 40 48	30 mm
15 80 40 49	35 mm
15 80 40 50	40 mm
15 80 40 51	45 mm

RUBBER MALLET

- ▶ Rubber head
- ▶ With tubular handle
- ▶ With soft grip



Item no. Contents

15 80 40 19	8 OZ
15 80 40 20	12 OZ
15 80 40 21	16 OZ
15 80 40 22	20 OZ
15 80 40 23	24 OZ
15 80 40 24	32 OZ

DEAD BLOW RUBBER MALLET

- ▶ Rubbers head for heavy and effective blows

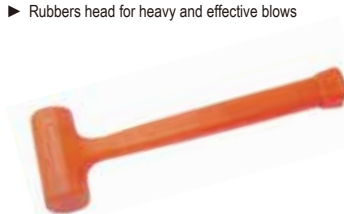

Item no. Contents

15 80 40 36	1.0 LB
15 80 40 37	1.5 LB
15 80 40 38	2.0 LB
15 80 40 39	3.0 LB
15 80 40 40	4.0 LB

TWO WAY MALLET

- ▶ Replaceable rubber/nylon head
- ▶ With wood handle



Item no. Contents

15 80 40 52	20 mm
15 80 40 53	25 mm
15 80 40 54	30 mm
15 80 40 55	35 mm
15 80 40 56	40 mm
15 80 40 57	45 mm





TWO WAY Mallet

- ▶ Replaceable rubber/nylon head
- ▶ With fiberglass handle
- ▶ With soft grip



Item no. Contents

15 80 40 58	20 mm
15 80 40 59	25 mm
15 80 40 60	30 mm
15 80 40 61	35 mm
15 80 40 62	40 mm
15 80 40 63	45 mm

Chipping Hammer

- ▶ With bleached wooden handle



Item no. Contents

15 85 40 01	200 g
15 85 40 02	300 g
15 85 40 03	400 g
15 85 40 04	500 g

Expert Claw Hammer

- ▶ Solid forged one piece fine grain carbon steel.
- ▶ Polished and lacquered all over
- ▶ Solid shaft with two components soft anti-slip TPR grip



Item no. Contents

15 55 40 03	16 OZ
-------------	-------

Wood Mallet

- ▶ With solid head and angled striking faces
- ▶ With tapered mortise shaft



Item no. Contents

15 80 00 01	80x50 mm
-------------	----------

Chipping Hammer, American Type

- ▶ Carbon steel
- ▶ With spring handle



Item no. Contents

15 85 40 05	200 g
15 85 40 06	300 g
15 85 40 07	500 g

Expert Claw Hammer

- ▶ Solid forged one piece fine grain carbon steel.
- ▶ Polished and lacquered all over
- ▶ Solid shaft with two components soft anti-slip TPR grip



Item no. Contents

15 55 40 05	16 OZ
-------------	-------

Car Body Repairing Hammer

- ▶ With wooden handle



Item no. Contents

15 85 20 01	
-------------	--

Expert Anti-Shock Roofing Hammer

- ▶ Solid forged one piece fine grain carbon steel
- ▶ Polished and lacquered all over
- ▶ Solid shaft with two components soft anti-slip TPR grip



Item no. Contents

15 55 40 02	600 g
-------------	-------

All Steel Stone Hammer

- ▶ Solid forged one piece tool steel
- ▶ Polished fully
- ▶ Solid shaft with two components soft anti-slip TPR grip



Item no. Contents

15 40 40 06	2 LB
15 40 40 07	3 LB
15 40 40 08	4 LB

Cross Pein Hammer

- ▶ With wooden handle



Item no. Contents

15 85 00 01	
-------------	--

All Steel Brick Hammer

- ▶ Solid forged one piece tool steel
- ▶ Polished
- ▶ Solid shaft with two components soft anti-slip TPR grip



Item no. Contents

15 50 40 03	600 g
-------------	-------

Stubby Claw Hammer

- ▶ Drop forged carbon steel
- ▶ With two components soft comfortable TPR handle



Item no. Contents

15 60 20 40	
-------------	--

STUBBY BALL PEIN HAMMER

- ▶ Drop forged carbon steel
- ▶ With two components soft comfortable TPR handle



Item no.	Contents
15 70 20 24	

ELECTRICIAN'S HAMMER, FRENCH TYPE

- ▶ Forged carbon steel
- ▶ Wooden handle



Item no.	Contents
15 85 00 02	15 mm
15 85 00 03	16 mm
15 85 00 04	18 mm
15 85 00 05	20 mm
15 85 00 06	22 mm
15 85 00 07	25 mm

ELECTRICIAN'S HAMMER, FRENCH TYPE

- ▶ Forged carbon steel
- ▶ With fiberglass handle
- ▶ With soft grip



Item no.	Contents
15 85 00 08	15 mm
15 85 00 09	16 mm
15 85 00 10	18 mm
15 85 00 11	20 mm
15 85 00 12	22 mm
15 85 00 13	25 mm

3PCS HAMMER SET



Item no.	Contents
15 90 00 04	

4PCS HAMMER SET



Item no.	Contents
15 90 00 05	

7 PCS CAR BODY REPAIR TOOL SET



Item no.	Contents
15 90 00 02	

7 PCS CAR BODY REPAIR TOOL SET



Item no.	Contents
15 90 00 06	

7 PCS CAR BODY REPAIR TOOL SET



Item no.	Contents
15 90 00 03	

HATCHET

- ▶ Forged carbon steel
- ▶ Head ground and polished
- ▶ With fiberglass handle, With soft grip



Item no.	Contents
15 10 00 01	600 g
15 10 00 02	800 g
15 10 00 03	1000 g
15 10 00 04	1250 g

HATCHET

- ▶ Forged carbon steel
- ▶ Head ground and polished
- ▶ With wooden handle



Item no.	Contents
15 10 00 05	600 g
15 10 00 06	800 g
15 10 00 07	1000 g
15 10 00 08	1250 g

HATCHET

- ▶ Forged carbon steel
- ▶ Head ground and polished
- ▶ With fiberglass handle
- ▶ With soft grip



Item no.	Contents
15 10 00 14	1 LB
15 10 00 15	1.25 LB
15 10 00 16	2 LB
15 10 00 17	3 LB
15 10 00 18	4 LB





HATCHET

- ▶ Forged carbon steel
- ▶ Head ground and polished
- ▶ With wooden handle



Item no.	Contents
15 10 00 09	1 LB
15 10 00 10	1.25 LB
15 10 00 11	2 LB
15 10 00 12	3 LB
15 10 00 13	4 LB

AXE WITH WEDGE

- ▶ Forged carbon steel
- ▶ Head ground and polished
- ▶ With fiberglass handle
- ▶ With soft grip



Item no.	Contents
15 10 20 01	1 kg
15 10 20 02	2 kg
15 10 20 03	3 kg
15 10 20 04	4 kg

SPLITTING AXE

- ▶ Forged carbon steel
- ▶ Head ground and polished
- ▶ With fiberglass handle
- ▶ Plastic coated
- ▶ With soft grip



Item no.	Contents
15 10 20 09	8 LB

HAMMERS AND HATCHET

HATCHET

- ▶ Forged carbon steel
- ▶ Head ground and lacquered
- ▶ With wooden handle



Item no.	Contents
15 10 00 19	450 g
15 10 00 20	600 g
15 10 00 21	800 g

SPLITTING AXE

- ▶ Forged carbon steel
- ▶ Head ground and polished
- ▶ With fiberglass handle
- ▶ With soft grip



Item no.	Contents
15 10 20 05	6 LB
15 10 20 06	8 LB

SPLITTING AXE

- ▶ Forged carbon steel
- ▶ Head ground and polished
- ▶ With wooden handle



Item no.	Contents
15 10 20 07	6 LB
15 10 20 08	8 LB



HATCHET

- ▶ Forged carbon steel
- ▶ Head ground and lacquered
- ▶ With wooden handle



Item no.	Contents
15 10 00 22	1.25 LB
15 10 00 23	2 LB



1/4" DR. SOCKET

► DIN3124



Item no.	S(mm)	S(inch)	H(mm)	L(mm)	g
20 10 00 01	4.0	5/32	11.8	25.0	10.0
20 10 00 02	4.5		11.8	25.0	10.0
20 10 00 03	5.0	3/16	11.8	25.0	10.0
20 10 00 04	5.5	7/32	11.8	25.0	10.0
20 10 00 05	6.0	1/4	11.8	25.0	10.0
20 10 00 06	7.0	9/32	11.8	25.0	13.5
20 10 00 07	8.0	5/16	11.8	25.0	12.5
20 10 00 08	9.0	11/32	12.8	25.0	14.0
20 10 00 09	10.0	3/8	14.5	25.0	18.0
20 10 00 10	11.0	7/16	15.8	25.0	22.0
20 10 00 11	12.0		16.8	25.0	25.0
20 10 00 12	13.0	1/2	17.8	25.0	26.0
20 10 00 13	14.0	9/16	19.8	25.0	35.0



3/8" DR. SOCKET

► DIN3124



Item no.	S(mm)	S(inch)	H(mm)	L(mm)	g
20 10 20 01	6.0	1/4	16.8	28.0	22.0
20 10 20 02	7.0	9/32	16.8	28.0	22.0
20 10 20 03	8.0	5/16	16.8	28.0	23.5
20 10 20 04	9.0	11/32	16.8	28.0	23.5
20 10 20 05	10.0	3/8	16.8	28.0	23.5
20 10 20 06	11.0	7/16	16.8	28.0	21.5
20 10 20 07	12.0		16.8	28.0	23.5
20 10 20 08	13.0	1/2	17.8	28.0	28.5
20 10 20 09	14.0	9/16	19.8	28.0	33.5
20 10 20 10	15.0		21.8	28.0	45.5
20 10 20 11	16.0	5/8	21.8	28.0	43.5
20 10 20 12	17.0	11/16	23.8	30.0	56.5
20 10 20 13	18.0		25.8	30.0	70.5
20 10 20 14	19.0	3/4	25.8	30.0	67.0
20 10 20 15	20.0		27.8	30.0	78.0
20 10 20 16	21.0	11/16	27.8	30.0	75.5
20 10 20 17	22.0	7/8	29.8	32.0	96.65
20 10 20 18	23.0		29.8	32.0	101.0
20 10 20 19	24.0	15/16	29.8	32.0	115.0

1/2" DR. SOCKET

► DIN3124



Item no.	S(mm)	S(inch)	H(mm)	L(mm)	g
20 10 40 01	8.0	5/16	21.8	36.0	22.0
20 10 40 02	9.0		21.8	38.0	22.0
20 10 40 03	10.0	3/8	21.8	39.0	23.5
20 10 40 04	11.0	7/16	21.8	38.0	23.5
20 10 40 05	12.0		21.8	45.0	23.5
20 10 40 06	13.0	1/2	21.8	46.0	21.5
20 10 40 07	14.0	9/16	21.8	54.0	23.5
20 10 40 08	15.0	19/32	21.8	56.0	28.5
20 10 40 09	16.0	5/8	21.8	53.0	33.5
20 10 40 10	17.0	11/16	23.8	71.0	45.5
20 10 40 11	18.0		24.8	78.0	43.5
20 10 40 12	19.0	3/4	25.5	78.0	56.5
20 10 40 13	20.0		27.8	97.5	70.5
20 10 40 14	21.0	13/16	27.8	91.0	67.0
20 10 40 15	22.0	7/8	29.8	114.0	78.0
20 10 40 16	23.0		31.8	140.5	75.5
20 10 40 17	24.0	15/16	31.8	134.0	96.65
20 10 40 18	25.0	1	33.8	147.0	101.0
20 10 40 19	27.0	1-1/16	27.8	180.0	115.0
20 10 40 20	30.0	1/3/16	39.8	238.0	
20 10 40 21	32.0	1-1/4	41.8	261.0	

1/4" DR. DEEP SOCKET

► DIN3124



Item no.	S(mm)	S(inch)	H(mm)	L(mm)	g
20 10 00 14	4.0	5/32	11.8	50.0	20.0
20 10 00 15	5.0	3/16	11.8	50.0	21.0
20 10 00 16	6.0	1/4	11.8	50.0	23.0
20 10 00 17	7.0	9/32	11.8	50.0	23.0
20 10 00 18	8.0	5/16	11.8	50.0	24.0
20 10 00 19	9.0	11/32	12.8	50.0	29.0
20 10 00 20	10.0	3/8	14.5	50.0	38.0
20 10 00 21	11.0	7/16	15.8	50.0	44.0
20 10 00 22	12.0		16.8	50.0	53.0
20 10 00 23	13.0	1/2	17.8	50.0	51.0
20 10 00 24	14.0	9/16	19.8	50.0	68.0

3/8" DR. DEEP SOCKET

► DIN3124



Item no.	S(mm)	S(inch)	H(mm)	L(mm)	g
20 10 20 20	6.0	1/4	16.8	63.0	50.0
20 10 20 21	7.0	9/32	16.8	63.0	51.0
20 10 20 22	8.0	5/16	16.8	63.0	52.0
20 10 20 23	9.0		16.8	63.0	56.0
20 10 20 24	10.0	3/8	16.8	63.0	60.0
20 10 20 25	11.0	7/16	16.8	63.0	68.0
20 10 20 26	12.0		16.8	63.0	68.0
20 10 20 27	13.0	1/2	17.8	63.0	64.0
20 10 20 28	14.0	9/16	19.8	63.0	72.0
20 10 20 29	15.0	19/32	20.8	63.0	88.0
20 10 20 30	16.0	5/8	21.8	63.0	88.0
20 10 20 31	17.0	11/16	23.8	63.0	112.0
20 10 20 32	18.0		23.8	63.0	112.0
20 10 20 33	19.0	3/4	25.8	63.0	124.0
20 10 20 35	21.0	13/16	27.8	63.0	126.0
20 10 20 36	22.0	7/8	29.8	63.0	128.0

1/2" DR. DEEP SOCKET

► DIN3124



Item no.	S(mm)	S(inch)	H(mm)	L(mm)	g
20 10 40 22	8.0	5/16	21.8	77.0	112.0
20 10 40 23	9.0		21.8	77.0	113.0
20 10 40 24	10.0	3/8	21.8	77.0	116.0
20 10 40 25	11.0	7/16	21.8	77.0	121.0
20 10 40 26	12.0		21.8	77.0	130.0
20 10 40 27	13.0	1/2	21.8	77.0	127.0
20 10 40 28	14.0	9/16	21.8	77.0	138.0
20 10 40 29	15.0		21.8	77.0	143.0
20 10 40 30	16.0	5/8	21.8	77.0	149.0
20 10 40 31	17.0	11/16	23.8	77.0	156.0
20 10 40 32	18.0		25.8	77.0	151.0
20 10 40 33	19.0	3/4	25.8	77.0	162.0
20 10 40 35	21.0	13/16	27.8	77.0	187.0
20 10 40 36	22.0	7/8	29.8	77.0	194.0
20 10 40 37	24.0	15/16	31.8	77.0	244.0
20 10 40 38	27.0	1-1/16	36.6	77.0	305.0
20 10 40 39	30.0	1-3/16	39.8	77.0	319.0
20 10 40 40	32.0	1-1/4	41.8	77.0	330.0

3/8" DR. SPARK PLUG SOCKET

► DIN3124



Item no.	S(mm)	S(inch)	H(mm)	L(mm)	g
20 30 00 01	16.0	5/8	21.8	63.0	100.0
20 30 00 02	19.0	3/4	25.8	65.0	150.0
20 30 00 03	21.0	13/16	27.8	65.0	180.0

1/2" DR. SPARK PLUG SOCKET

► DIN3124



Item no.	S(mm)	S(inch)	H(mm)	L(mm)	g
20 30 00 04	16.0	5/8	21.8	63.0	100.0
20 30 00 05	19.0	3/4	25.8	65.0	150.0
20 30 00 06	21.0	13/16	27.8	65.0	180.0

1/4" STAR SOCKET WRENCH



Item no.	S	S(inch)	L(mm)
20 10 00 40	E4		25
20 10 00 41	E5		25
20 10 00 42	E6		25
20 10 00 43	E7		25
20 10 00 44	E8		25
20 10 00 45	E9		25
20 10 00 46	E10		25
20 10 00 47	E11		25



3/8" STAR SOCKET WRENCH



Item no.	S	S(inch)	L(mm)
20 10 20 40	E4		28
20 10 20 41	E5		28
20 10 20 42	E6		28
20 10 20 43	E7		28
20 10 20 44	E8		28
20 10 20 45	E9		28
20 10 20 46	E10		28
20 10 20 47	E11		28
20 10 20 48	E12		28
20 10 20 49	E14		28
20 10 20 50	E16		28
20 10 20 51	E18		28
20 10 20 52	E20		28

1/4" SOCKET WRENCH 8PT



Item no.	S	S(inch)	L(mm)
20 10 50 01		1/4	20.5
20 10 50 02		5/16	20.5
20 10 50 03		3/8	20.5
20 10 50 04		1/4	25
20 10 50 05		5/16	25
20 10 50 06		3/8	25

1/4" DR. EXTENSION BAR

► DIN3123



Item no.	S(inch)	H(mm)	L(mm)	g
20 80 10 01	2	12.3	50.0	23.0
20 80 10 02	3	12.3	75.0	29.0
20 80 10 03	4	12.3	100.0	44.0
20 80 10 04	6	12.3	150.0	64.0
20 80 10 05	8	12.3	250.0	108.0

1/4" DR. UNIVERSAL JOINT

► DIN3123



Item no.	S(inch)	H(mm)	L(mm)	g
20 80 00 01	1/4	14.0	38.0	22.0
20 80 00 02	3/8	18.0	55.0	67.0
20 80 00 03	1/2	24.8	73.0	151.0

3/8" DR. EXTENSION BAR (3F124)

► DIN3123



Item no.	S(inch)	H(mm)	L(mm)	g
20 80 10 06	3	16.8	75.0	75.0
20 80 10 07	6	16.8	150.0	146.0
20 80 10 08	10	16.8	250.0	240.0

1/2" STAR SOCKET WRENCH



Item no.	S	S(inch)	L(mm)
20 10 40 50	E10		38
20 10 40 51	E11		38
20 10 40 52	E12		38
20 10 40 53	E14		38
20 10 40 54	E16		38
20 10 40 55	E18		38
20 10 40 56	E20		38
20 10 40 57	E22		38
20 10 40 58	E24		38

1/4" DR. UNIVERSAL JOINT

► DIN3122



Item no.	S(inch)	H(mm)	L(mm)	g
20 80 60 01	1/4	24.0	115.0	45.0
20 80 60 02	3/8	32.0	165.0	160.0
20 80 60 03	1/2	42.0	250.0	353.0

1/2" DR. EXTENSION BAR (4410321)

► DIN3123



Item no.	S(inch)	H(mm)	L(mm)	g
20 80 10 09	3	21.8	75.0	138.0
20 80 10 10	5	21.8	150.0	370.0
20 80 10 11	10	21.8	250.0	433.0

REVERSIBLE RATCHET HANDLE

- ▶ Quick release
- ▶ Forged hardened steel
- ▶ Matte chrome-plated
- ▶ With black plastic non-slip handle



Item no. Contents

20 50 00 01	1/4"
20 50 20 01	3/8"
20 50 40 01	1/2"

REVERSIBLE RATCHET HANDLE

- ▶ Quick release
- ▶ Forged hardened steel
- ▶ Fully-polished chrome-plated.



Item no. Contents

20 50 00 04	1/4"
20 50 20 04	3/8"
20 50 40 04	1/2"

REVERSIBLE RATCHET HANDLE

- ▶ Quick release
- ▶ Forged hardened steel
- ▶ Fully-polished chrome-plated.



Item no. Contents

20 50 00 08	1/4"
-------------	------

STUBBY REVERSIBLE RATCHET HANDLE

- ▶ DIN3122 72T
- ▶ Quick release
- ▶ Forged hardened steel
- ▶ Chrome-plated
- ▶ With bi-color plastic non-slip handle



Item no. Contents

20 50 00 02	1/4"
20 50 20 02	3/8"
20 50 40 02	1/2"

REVERSIBLE RATCHET HANDLE

- ▶ 72T Quick release , curved handle
- ▶ Forged hardened steel
- ▶ With bi-color plastic handle



Item no. Contents

20 50 00 05	
-------------	--

1/2" DR. FLEX HANDLE

- ▶ DIN3122
- ▶ Forged hardened steel
- ▶ Chrome-plated
- ▶ Knurling handle



Item no. Contents

20 50 00 06	10" (271.5mm)
	15" (386.5mm)
	18" (466.5mm)
	24" (616.5mm)

REVERSIBLE RATCHET HANDLE

- ▶ Forged hardened steel
- ▶ Chrome-plated
- ▶ With non-slip plastic handle



Item no. Contents

20 50 00 03	1/4"
20 50 20 03	3/8"
20 50 40 03	1/2"

STUBBY REVERSIBLE RATCHET HANDLE

- ▶ DIN3122 72T
- ▶ Quick release
- ▶ Forged hardened steel
- ▶ Chrome-plated
- ▶ With bi-color plastic non-slip handle



Item no. Contents

20 50 00 07	1/4"
-------------	------

REVERSIBLE RATCHET HANDLE

- ▶ Quick release
- ▶ Forged hardened steel
- ▶ Fully-polished chrome-plated.



Item no. Contents

20 50 00 09	1/4"
-------------	------

10PCS 1/2" DR. IMPACT SOCKET SET

- ▶ 1/2" Driver
- ▶ For pneumatic drill and ratchet screwdriver
- ▶ Size:10/11/12/13/14/17/19/21/22/24mm
- ▶ In plastic box



Item no. Contents

20 90 40 01	
-------------	--

14PCS 1/4" DR. SOCKET SET

- ▶ 1pc 1/4" Dr. quick release ratchet handle
- ▶ 13pcs 1/4" Dr. socket 4/4.5/5/5.5/6/7/8/9/10/11/12/13/14mm
- ▶ On plastic hanging card



Item no. Contents

20 90 20 01	14pcs
-------------	-------



11PCS 3/8" DR. SOCKET SET

- ▶ 1pc 3/8" Dr. quick release ratchet handle
- ▶ 10pcs 3/8" Dr. socket 10/11/12/13/14/15/16/17/19/22mm
- ▶ On plastic hanging card



Item no. Contents

20 90 30 01 11pcs

11 PCS SOCKET SET



Item no. Contents

20 90 20 11	1/4"10PC(5, 6, 7, 8, 9, 10, 11, 12, 13, 14)
20 90 30 11	3/8"10PC(8, 9, 10, 11, 12, 13, 14, 17, 19, 21)
20 90 40 11	1/2"10PC(8, 9, 10, 11, 12, 14, 17, 19, 21, 24)

25 PCS 1/4" SOCKET SET



Item no. Contents

20 90 50 03	11 pcs 1/4" socket 4, 5, 6, 7, 8, 9, 10, 11, 12, 13, 14mm
	11 pcs 1/4" socket 5/32, 3/16, 7/32, 1/4, 9/32, 5/16, 11/32, 3/8, 7/16, 1/2, 9/16"
	1 pc 1/4" ratchet handle
	2 pcs 1/4" extension bar 4",6"

19PCS 1/2" DR. SOCKET SET

- ▶ 1pc 1/2" Dr. quick release ratchet handle
- ▶ 18pcs 3/8" Dr. socket 8/9/10/11/12/13/14/15/16/17/18/19/20/22/24/27/30/32mm
- ▶ On plastic hanging card



Item no. Contents

20 90 40 02 19pcs

11 PCS SOCKET SET



Item no. Contents

20 90 20 12	1/4"10PC(5, 6, 7, 8, 9, 10, 11, 12, 13, 14)
20 90 30 12	3/8"10PC(8, 9, 10, 11, 12, 13, 14, 17, 19, 21)
20 90 40 12	1/2"10PC(8, 9, 10, 11, 12, 14, 17, 19, 21, 24) with 10cm extension bar

29 PCS 1/4" SOCKET & BIT SET



Item no. Contents

20 90 50 04	12 pcs 1/4"socket 4, 4.5, 5, 6, 7, 8, 9, 10, 11, 12, 13, 14mm
	14 pcs 1/4"socket bits SLOT4, 5, 7;
	PH1, 2;T10, 15, 20, 25, 30;
	HW3, 4, 5, 6
	1 pc 1/4"ratchet handle
	2 pcs 1/4"extension bar 4",6"

11 PCS SOCKET SET



Item no. Contents

20 90 20 10	1/4"10PC(5, 6, 7, 8, 9, 10, 11, 12, 13, 14)
20 90 30 10	3/8"10PC(8, 9, 10, 11, 12, 13, 14, 17, 19, 21)
20 90 40 10	1/2"10PC(8, 9, 10, 11, 12, 14, 17, 19, 21, 24)

23 PCS 1/4" SOCKET SET



Item no. Contents

20 90 50 02	11 pcs 1/4" socket 4, 5, 6, 7, 8, 9, 10, 11, 12, 13, 14mm
	11 pcs 1/4" socket 5/32, 3/16, 7/32, 1/4, 9/32, 5/16, 11/32, 3/8, 7/16, 1/2, 9/16"
	1 pc 1/4" ratchet handle"

12 PCS 1/4" & 3/8" & 1/2" SOCKET BIT SET



Item no. Contents

20 90 50 05	1/4" T10, 15, 20, 15, 27, 30
	3/8" T30, 40, 45, 50, 55
	1/2" T60"

SOCKET AND RATCHET HANDLE

10 PCS 1/4" & 3/8" TORX SOCKET SET



Item no. Contents

20 90 50 06	5 PCS 1/4" : E4, 5, 6, 7, 8 5 PCS 3/8" : E10, 12, 14, 16, 18
-------------	-----------------------------------------------------------------------

10 PCS SOCKET SET



Item no. Contents

20 90 50 07	1/4": 4, 5, 6, 7, 8, 9, 10, 11, 12, 13"
-------------	--------------------------------------------

10 PCS SOCKET SET



Item no. Contents

20 90 50 08	3/8": 10, 11, 12, 13, 14, 15, 16, 17, 18, 19 1/2": 10, 13, 14, 15, 1 6, 17, 18, 19, 21, 22
-------------	-----------------------------------------------------------------------------------------------------

"10 PCS DEEP SOCKET



Item no. Contents

20 90 50 09	1/4": 4, 5, 6, 7, 8, 9, 10, 11, 12, 13 3/8": 10, 11, 12, 13, 14, 15, 16, 17, 18, 19 1/2": 10, 13, 14, 15, 16, 17, 18, 19, 21, 22
-------------	-------------------------------------------------------------------------------------------------------------------------------------------------

27PCS. 1/2" DR. SOCKETS SET

- ▶ All parts made of Cr-V steel
- ▶ Packed in metal box



Item no. Contents

20 90 40 03	18pcs. 1/2" dr. metric sockets 10/11/12/1 3/14/15/16/17/18/19/20/ 21/22/23/24/27/30/32mm 2 pcs spark plug sockets 16/21mm 7 pcs accessories -quick release ratchet handle(with 72 teeth) -Flex handle 10" -universal joint -extension bars 3", 5" & 10" -3/8"Fx1/2" M 3-way adapter
-------------	----------------------------------------------------------------------------------------------------------------------------------------------------------------------------------------------------------------------------------------------------------------------------------------------------------------------

26PCS. 1/2" DR. SOCKETS SET

- ▶ All parts made of Cr-V steel
- ▶ Packed in metal box



Item no. Contents

20 90 40 04	2 pcs. spark plug sockets: 16, 21 mm 6 pcs. accessories - quick release ratchet handle - sliding T-bar - universal joint - extension bars 3"-5"-10"
-------------	--------------------------------------------------------------------------------------------------------------------------------------------------------------------

29 PCS 1/2" DR. SOCKETS SET

- ▶ All parts made of Cr-V steel.
- ▶ Packed in metal box



Item no. Contents

20 90 40 05	18 pcs. metric sockets 10, 11, 12, 13, 14, 15, 16, 17, 18, 19, 20, 21, 22, 23, 24, 27, 30, 32mm 4pcs deep sockets 1, 13, 17, 19mm 2pcs spark plug sockets: 16, 21 mm 5pcs accessories - quick release ratchet handle - sliding T-bar 10" - universal joint - extension bars 5"-10"
-------------	---------------------------------------------------------------------------------------------------------------------------------------------------------------------------------------------------------------------------------------------------------------------------------------------------------------------



21 PCS 1/2" SOCKET SET



Item no.	Contents
20 99 00 01	16 pcs 1/2" socket 10-32mm 2 pcs 1/2" extension bar 125,250mm 1 pc 1/2" ratchet handle 1 pc 1/2" sliding bar 250mm 1 pc 1/2" universal joint

26 PCS 1/2" SOCKET SET



Item no.	Contents
20 99 00 02	16 pcs 1/2" socket 10-32mm 2 pcs 1/2" extension bar 75,125mm 1 pc 1/2" ratchet handle 1 pc 1/2" sliding bar 250mm 1 pc 1/2" extension bar 250mm 1 pc 3 way adaptor 1 pc Flex handle 2 pcs spark plug sockets 16,21mm 1 pc 1/2" universal joint

24 PCS 1/2" SOCKET SET



Item no.	Contents
20 99 00 03	18 pcs 1/2" socket 10-32mm 2 pcs 1/2" extension bar 125,250mm 1 pc 1/2" ratchet handle 1 pc 1/2" sliding bar 250mm 1 pc 1/2" universal joint 1 pc socket wrench

22 PCS. 3/8" DR. SOCKETS SET

- ▶ All parts made of Cr-V steel,
- ▶ Packed in metal box



Item no.	Contents
20 90 30 02	15 pcs. metric sockets: 6-7-8-9-10-11-12-13-14-15-16-17-18-19-22mm 2 pcs.spark plug sockets 16, 21mm 5pcs accessories -quick release ratchet handle(72 teeth) -sliding T-bar -universal joint -extension bars 3" & 6"

23 PC 3/8" DR. SOCKET SET

- ▶ All parts made of Cr-V steel,
- ▶ Packed in metal box



Item no.	Contents
20 90 30 03	16 pcs. metric sockets 8-9-10-11-12-13-14-15-16-17-18-19-20-21-22-24 mm 2 pcs.spark plug sockets 16,21 mm 5 pcs.accessories -quick release ratchet handle -sliding T-bar 165mm -universal joint -extension bars 3" & 6"

33PCS.1/4" DR. SOCKETS SET

- ▶ All parts made of Cr-V steel
- ▶ Packed in metal box



Item no.	Contents
20 90 20 02	12pcs. 1/4" dr. metric sockets 4-4.5-5-5.5-6-7-8-9-10-11-12-13mm 3pcs hex keys 1.5-2-2.5 mm 12 pcs. bit sockets Slotted:3-4-5.5-6-5-8mm Phillips:PH1, PH2 Hexagon: 3-4-5-6-8 mm 1-quick release ratchet handle (with 72 teeth) 1-sliding T-bar 1-universal joint 2-extension bars 2" & 4" 1-spinner handle

1/4" 22PCS BITS AND SOCKETS SET

- ▶ Professional quality.
- ▶ Manufactured from chrome vanadium steel hardened , tempered,
- ▶ Bits fully sand blasting and sockets chrome plated for protection of corrosion
- ▶ Packed in aluminum case with window.



Item no. Contents

20 90 20 09	10pcs crv bits: sl:5-7 ph:1-2-3 torx: 10-15-20-25-30
	8pcs crv sockets, satin chrome plated: 6-7-8-9-10-11-12-13mm
	1pcs bit adaptor
	1pcs 70mm extention bar
	1pcs universal joint
	1pcs crv reversible ratchet handle.

26 PCS 1/2' DR. SOCKETS SET

- ▶ Packed in blow case



Item no. Contents

20 90 40 06	18pcs. 1/4" dr. metric sockets 10-11-12-13-14-15-16-17-18-19-20-21-22-23-24-27-30-32mm
	2 pcs spark plug sockets 16-21mm
	6 pcs accessories -quick release ratchet handle(with 72 teeth) -sliding T-bar -universal joint -extension bars 3", 5" & 10"

26 PCS 1/2" DR. SOCKETS SET



Item no. Contents

20 90 40 08	18 pcs sockets: 32,30,27,24,23,22,21,20,19,18,17,16,15,14,13,12,11,10mm
	2 pcs spark plug socket:16mm+21mm
	3 pcs extension bars: 1/4"x70mm,1/2"x125mm,1/2"x250mm 1pc 1/2" universal joint
	1 pc quick release ratchet handle
	1pc 1/2" T sliding bars
	All material is carbon steel - Cr-V Packed in blow mould case

29 PCS 1/4" SOCKET & BITS SET



Item no. Contents

20 99 00 04	11 pcs 1/4" sockets 4-14mm
	12 pcs 1/4" socket bits
	1 pc 1/4" ratchet handle
	2 pcs 1/4" extension bar 50,100mm
	1 pc 1/4" spinner handle
	1 pc 1/4" sliding bar
	1 pc 1/4" universal joint

23 PCS 1/2' DR. SOCKETS SET



Item no. Contents

20 90 40 07	15 pcs 1/2" dr. sockets 10,11,12,13,14,15,16,17,18,19,20,22,24,27,30,32mm
	2 pcs 1/2" dr. spark plug sockets 16, 21 mm
	2 pcs 1/2" dr. extension bar: 5", 10"
	1 pc 1/2" dr. quick ratchet handle
	1 pc 1/2" dr. universal joint
	1 pc3 way adaptor
	1 pc blow case

22 PCS 1/2" DR. SOCKET SET



Item no. Contents

20 99 00 05	15 pcs 1/2" sockets 10-32mm
	1 pc 1/2" ratchet handle
	2 pcs 1/2" spark plug sockets 16,21mm
	2 pcs 1/2" extension bar 5",10"
	1 pc 1/2" 3 way adaptor
	1 pc 1/2" universal joint



37 pcs socket set



Item no. Contents

20 99 00 06	19 pcs 1/2" sockets 8-32MM 2 pcs 1/2" spark plug sockets 16mm,21mm 1 pc 1/2" extension bar 10" 1 pc 1/2" universal joint 1 pc 3 way adaptor 1 pc 1/2" ratchet handle 12 pcs combination spanners 8-22mm 1 pc blow mould case
--------------------	---------------------------------------------------------------------------------------------------------------------------------------------------------------------------------------------------------------------------------------------------

33 PCS 1/2" SOCKET SET



Item no. Contents

20 99 00 08	19 pcs 6 points sockets 8-32mm 6 pcs 12 points sockets 10-19mm 2 pcs 1/2" extension bars 5",10" 1 pc 3 way adaptor 1 pc 1/2" ratchet handle 1 pc 1/2" universal joint 2 pcs spark plug wrench 16,21mm 1 pc blow mould case
--------------------	-------------------------------------------------------------------------------------------------------------------------------------------------------------------------------------------------------------------------------------------------

29 PCS 3/8" DR. SOCKETS SET



Item no. Contents

20 90 30 05	15 PCS 3/8" SOCKETS 6,7,8,9,10,11,12,13,14,15,16,17,18,19, 22mm 2 pcs spark plug sockets 16,21mm 1 pc quick release ratchet handle 1 pc sliding bar 1 pc universal joint 2 pc extension bar 3", 6" 1 pc blow case
--------------------	-------------------------------------------------------------------------------------------------------------------------------------------------------------------------------------------------------------------------------------

59 PCS 1/2" SOCKET SET



Item no. Contents

20 99 00 07	8 pcs 1/2" socket 10-19mm 17 pcs 1/2" socket 10-32mm 25 pcs 8X30mm bits 1 pc 1/2" ratchet handle 2 pcs 1/2" extension bars 5" 10" 2 pcs 1/2" spark plug wrench 16,21MM 1 pc 1/2" universal joint 1 pc 3 way adaptor 1 pc 1/2" bits adaptor 1 pc blow mould case
--------------------	--------------------------------------------------------------------------------------------------------------------------------------------------------------------------------------------------------------------------------------------------------------------------------------------

11 PCS 1/2" SOCKET SET



Item no. Contents

20 99 00 09	9PCS-1/2" sockets set 8-24MM 1PCS-1/2" L-type wrench 250MM 1PCS-blow mould case
--------------------	---------------------------------------------------------------------------------------

39 PCS 3/8" SOCKET SET



Item no. Contents

20 99 00 10	11 pcs 3/8" sockets 4-11mm 1 pc 3/8" ratchet handle 2 pcs extension bar 50,150mm 1 pc sliding bar 110mm 1 pc universal joint 20 pcs bits 1 pc bit adaptor 1 pc spinner handle 1 pc blow mould case
--------------------	----------------------------------------------------------------------------------------------------------------------------------------------------------------------------------------------------------------------------

22 PCS 3/8" DR. SOCKETS SET



Item no. Contents

20 90 30 04	15 PCS 3/8" SOCKETS:6,7,8,9,10,11,12,13,14,15,16,17,18,19,22mm 2 pcs spark plug sockets 16,21mm 1 pc quick release ratchet handle 1 pc sliding bar 1 pc universal joint 2 pc extension bar 3", 6" 1 pc blow case
--------------------	------------------------------------------------------------------------------------------------------------------------------------------------------------------------------------------------------------------------------------

SOCKET AND RATCHET HANDLE

26 PCS 3/8" DR. SOCKET SET



Item no.	Contents
20 99 00 11	18 pcs 3/8" sockets 6-24mm 1 pc 3/8" ratchet handle 2 pcs 3/8" spark plug sockets 16,21mm 3 pcs 3/8" extension bar 2",3",6" 1 pc 3/8" 3 way adaptor 1 pc 3/8" universal joint

65 PCS 1/4" DR. SOCKETS AND BITS SET



Item no.	Contents
20 90 20 03	16pcs 1/4"x50mm bits: 3pcs PH: PH1-PH2-PH3 3pcs PZ: PZ0-PZ1-PZ2 4pcs Hex: H3-H4-H5-H6 3pcs Torx: T15-T20-T25 3pcs SL: 3-4-5mm 17 pcs 1/4"x25mm bits 3 pcs PH: PH0-PH1-PH2 3 pcs PZ: PZ0-PZ1-PZ2 4 pcs SL: 3-4-5-6mm 3 pcs Torx: T15-T20-T25 4 pcs Hex: H3-H4-H5-H6 9 pcs socket bits 2 pcs SL:4-5.5mm 3 pcs PH: PH1-PH2-PH3 2 pcs PZ: T15-T20 2 pcs Hex: H3-H4 1 pc 1/4" dr. ratchet handle 72T 1 pc 1/4" screwdriver handle 1 pc Extension bat 50mm 1 pc 1/4" sliding bar 110mm 1 pc 1/4" flexible bar 150mm 1 pc 1/4" socket adapter 1 pc 1/4" universal joint 3 pcs Hex Key 13 pcs 1/4" sockets

26PCS 1/4" DR. SOCKETS SET



Item no.	Contents
20 90 20 04	14 pcs 1/4" dr. sockets 4/4.5/5/5.5/6/6.5/7/8/9/ 10/11/12/13/14 mm 5 pcs 1/4" dr. deep sockets 8/10/11/12/13mm 1 pc 1/4" dr. universal joint 2 pc 1/4" extension bar: 2" & 4" 1 pc 1/4" dr. sliding bar 1 pc 1/4" dr. quick release ratchet handle 1 pc 1/4" dr. spinner handle 1 pc blow case

22 PCS 1/4" DR. SOCKETS SET



Item no.	Contents
20 90 20 05	9 pcs 1/4" dr. sockets 4/5/5.5/6.3/7/8/9/10/11 7 pcs 1/4" dr. deep sockets 6/6.3/7/8/9/10/11mm 1 pc 1/4" dr. universal joint 2 pcs 1/4" extension bar: 2" & 6" 1 pc 1/4" dr. quick release ratchet handle 1 pc 1/4" dr. spinner handle 1 pc palm ratchet 1 pc blow case

46 PCS 1/4" DR. SOCKETS AND BITS SET



Item no.	Contents
20 90 20 06	13 pcs 1/4" dr. sockets 4/4.5/5/5.5/6/7/8/9/10/11/12/13/14mm 22 pcs 1/4" dr. sockets bits 1 pc 1/4" dr. universal joint 2 pcs 1/4" extension bar: 2" & 6" 1 pc 1/4" dr. quick release ratchet handle 1 pc 1/4" dr. spinner handle 1 pc flexible bar 1 pc sliding bar 1 bits adaptor 3 pcs hex key 1 pc blow case

53 PCS 1/4" DR. SOCKETS AND BITS SET



Item no.	Contents
20 90 20 07	13 pcs 1/4" dr. sockets 4/4.5/5/5.5/6/7/8/9/10/11/12/13/14mm 21 pcs 1/4" dr. sockets bits 7 pcs 1/4" deep sockets: 6/7/8/10/11/12/13mm 1 pc 1/4" dr. universal joint 2 pcs 1/4" extension bar: 2" & 4" 1 pc 1/4" dr. quick release ratchet handle 1 pc 1/4" dr. spinner handle 1 pc flexible bar 1 pc sliding bar 1 pc bits adaptor 4 pcs hex key 1 pc blow case



40 PCS 1/4" DR. SOCKETS SET



Item no. Contents

20 90 20 08	37 pcs sockets 1 pc ratchet handle 1 pc extension bar 1 pc plastic case
--------------------	----------------------------------------------------------------------------------

31 PCS 1/4" DR. SOCKET SET



Item no. Contents

20 99 00 12	12 pcs 1/4" socket 4-13mm 12 pcs 1/4" deep socket 4-13mm 1 pc 1/4" ratchet handle 1 pc 1/4" sliding bar 3 pcs 1/4" extension bar 2", 4", 6" 1 pc 1/4" universal joint 1 pc 1/4" spinner handle
--------------------	------------------------------------------------------------------------------------------------------------------------------------------------------------------------------------------------------------------



49 PCS 1/4" & 1/2" SOCKETS SET



Item no. Contents

20 90 20 21	13 pcs 1/4" dr. sockets: 4/4.5/5/5.5/6/7/8/9/10/11/12/13/14mm 2 pcs 1/4" extension bar: 2" & 4" 1 pc 1/4" dr. universal joint 1 pc 1/4" dr. quick release ratchet handle 1 pc 1/4" dr. spinner handle 1 pc 1/4" dr. flexible extension 6" 1 pc 1/4" dr. sliding bar 18 pcs 1/2" dr. sockets: 10/11/12/13/14/15/16/17/18/19/20/21/22/23/24/27/30/32mm 2 pcs 1/2" extension bar: 5" & 10" 1 pc 1/2" dr. universal joint 1 pc 1/2" dr. quick release ratchet handle 3 pcs hex key 1.5, 2, 2.5mm 1 pc 3 way adaptor 1 pc blow case
--------------------	-----------------------------------------------------------------------------------------------------------------------------------------------------------------------------------------------------------------------------------------------------------------------------------------------------------------------------------------------------------------------------------------------------------------------------------------------------------------------------------------------------------------------------------------------------------------------

40 PCS 1/4" & 1/2" SOCKET SET



Item no. Contents

20 99 00 15	12 pcs 1/4" socket set 4-14mm 1 pc 1/4" ratchet handle 1 pc 1/4" spinner handle 2 pcs extension bar 50, 100mm 1 pc 1/4" universal joint 17 pcs 1/2" socket set 8-24mm 1 pc 1/2" ratchet handle 2 pc extension bar 125, 250mm 1 pc 1/2" universal joint 1 pc 3 way adaptor 1 pc blow mould case
--------------------	------------------------------------------------------------------------------------------------------------------------------------------------------------------------------------------------------------------------------------------------------------------------------------------------------------------------------

94 PCS 1/4" & 1/2" SOCKETS SET



Item no. Contents

20 90 20 22	13 pcs 1/4" dr. sockets: 4/4.5/5/5.5/6/7/8/9/10/11/12/13/14mm 8 pcs 1/4" dr. deep sockets 6/7/8/9/10/11/12/13mm 17 pcs 1/4" dr. socket bits 15 pcs 8x30mm bits 2 pcs 1/4" extension bar: 2" & 4" 1 pc 1/4" dr. universal joint 1 pc 1/4" dr. quick release ratchet handle 1 pc 1/4" dr. spinner handle 1 pc 1/4" dr. sliding bar 1 pc flexible extension bar 1 pc bits adaptor 1/4" Sx1/4" H 18 pcs 1/2" dr. sockets: 10/11/12/13/14/15/16/17/18/19/20/21/22/23/24/27/30/32mm 4 pcs 1/2" dr. deep sockets: 14/15/17/19mm 2 pcs 1/2" dr. spark plug sockets 2 pcs 1/2" dr. extension bar: 5" & 10" 1 pc 1/2" dr. universal joint 1 pc 1/2" dr. quick release ratchet handle 3 pcs hex key 1.5, 2, 2.5mm 1 pc 3 way adaptor 1 pc 1/2" dr. bit adaptor 1 pc blow case
--------------------	--------------------------------------------------------------------------------------------------------------------------------------------------------------------------------------------------------------------------------------------------------------------------------------------------------------------------------------------------------------------------------------------------------------------------------------------------------------------------------------------------------------------------------------------------------------------------------------------------------------------------------------------------------------------------------------------------------------------------------------------------------------------------------------------------------------------------------

SOCKET AND RATCHET HANDLE

66 PCS 1/4" & 1/2" SOCKET SET



Item no.	Contents
20 99 00 16	12 pcs 1/4" sockets 4-13mm
	14 pcs 1/2" sockets 14-32mm
	2 pcs 1/2" spark plug sockets 16,21mm
	2 pcs 1/2" extension bar 3",10"
	1 pc 1/2" universal joint
	1 pc 1/2" quick ratchet handle
	12 pcs bits
	1 pc 1/4" extension bar 2"
	1 pc 1/4" spinner handle 6"
	1 pc 1/4" sliding bar
	1 pc 1/4" universal joint
	1 1/4" quick ratchet handle
	1 pc 1/4" coupler
	3 pcs hex key wrenches 1.5,2,2.5mm
	1 pc blow case

160 PCS 1/4" & 3/8" & 1/2" SOCKET SET



Item no.	Contents
20 99 00 17	13 pcs 1/4" socket 4-14mm
	5 pcs 1/4" deep socket 5.5-9mm
	1 pc 1/4" sliding bar
	2 pcs 1/4" extension bar 2",4"
	3 pcs 1/4" & 3/8" & 1/2" universal joint
	1 pc 1/4" spinner handle 6"
	3 pcs 1/4" & 3/8" & 1/2" ratchet handle
	1 pc 1/4"(M) & 3/8"(F) adaptor
	19 pcs 1/4" bit sockets
	PH1,2;PZ1,2;FD4,4.5,6,7;
	T8,10,15,20,25,27,30;HW3,4,5,6;
	8 pcs 3/8" sockets 10-19mm
	8 pcs 3/8" Torx sockets E8-E20
	6 pcs 3/8" deep sockets 10-15mm
	1 pc 3/8" spark plug socket 21mm
	1 pc 3/8" bit holder 5/16"
	2 pcs 3/8" extension bar 3",10"
	4 pcs 1/2" impact sockets 17-23mm
	10 pcs 1/2" sockets 17-32mm
	3 pcs 1/2" deep sockets 17,19,22mm
	2 pcs 1/2" extension bar 5",10"
	2 pcs 1/2" & 3/8" 3 way adaptor
	1 pc 3/8"(M) & 1/2"(F) Adaptor
	1 pc 1/2" bit holder 10mm
	2 pcs 1/2" spark plug socket 16,21mm
	2 pcs 1/4" 8X50mm adaptor
	34 pcs bits
	12 pcs spanners 8-22mm
	9 pcs hex key wrenches 1.5-10mm
	3 pcs wrenches: 8-10,13-15,17-19MM
	1 pc blow mould case

120PCS 1/2" & 3/8" & 1/4" SOCKETS SET



Item no.	Contents
20 99 00 18	7PCS-1/2" sockets 20-32mm
	14PCS-3/8" sockets 6-19mm
	8PCS-3/8" sockets E8-E20mm
	4PCS-1/2" Impact Sockets 17-23mm
	10PCS-1/4" socket bits T10-T40,ST20-ST30
	4PCS-3/8" sockets E13-E17mm
	17PCS-3/8" socket bits
	T20-T60;HW3-6mm ;PH1-2;
	SLOT 5.5,6.5mm;PZ1,PZ2
	4PCS-3/8" sockets 8-12mm
	13PCS-1/4" sockets 4-13mm
	3PCS-1/4" & 3/8" & 1/2" universal joints
	1PCS -bit adaptor
	1PCS-1/4" spinner handle
	2PCS-3/8" spark plug sockets 16mm, 21mm
	10PCS-combination wrench 8-19 mm
	5PCS-1/4" extension bar 2",3/8"
	extension bar 3",8", 1/2"
	extension bar 5",1/2" extension bar 10"
	3PCS-1/4" & 3/8" & 1/2" ratchet handles
	2PCS-adaptors
	1PCS-L-type wrench
	9PCS-hex key wrenches 1.5-10MM
	1PCS-100MM socket bit T52
	1PCS-blow mould case





52 PCS SOCKET & TOOL KIT WITH ALUMINUM CASE



Item no.	Contents
20 99 00 13	16 pcs 1/2" sockets 9-27mm 1 pc 1/2" ratchet handle 1 pc 1/2" universal joint 2 pcs 1/2" spark plug sockets 16,21mm 2 pcs 1/2" extension bar 5".10" 1 pc 3 way adaptor 10 pcs 1/4" sockets 4-11MM 1 pc 1/4" ratchet handle 2 pcs 1/4" extension bar 3",6" 1 pc 1/4" universal joint 1 pc 1/4" socket adaptor 1 pc 1/4" spinner handle 12 pcs bits 3 pcs hex key 1.5,2,2.5mm 1 pc aluminum case

91 PCS SOCKET & TOOL KIT WITH ALUMINUM CASE



Item no.	Contents
20 99 00 14	13 pcs 1/2" sockets 14-32mm 1 pc 1/2" ratchet handle 1 pc 1/2" universal joint 2 pcs 1/2" spark plug sockets 16,21mm 2 pcs sliding bar 5",10" 1 pc 3 way adaptor 1 pc 1/2" socket adaptor 8mm 13 pcs 1/4" sockets 4-14mm 1 pc 1/4" ratchet handle 1 pc 1/4" spinner handle 2 pcs 1/4" extension bar 2".4" 1 pc 1/4" universal joint 1 pc 1/4" sliding bar 1 pc 1/4" bit adaptor 16 pcs 8X30mm bits 16 pcs 6.3mmx25mm bits 9 pcs spanners 8-22mm 9 pcs precision screwdrivers 1 pc aluminum case

105 PCS 1/4" & 1/2" SOCKETS SET



Item no.	Contents
20 90 20 23	15 pcs 1/2" dr. sockets: 13-14-15-16-17-18-19-20-21-22-23-24-27-30-32mm 4 pcs 1/2" deep sockets 10-13-17-19mm 2 pcs 1/2" spark plug sockets: 16, 21 mm 1 pc 1/2" universal joint 1 pc 1/2" dr. 3 way adaptor 2 pc 1/2" extension bar 125mm, 250mm 2 pcs 1/4" & 1/2" quick release ratchet handle 12 pcs 1/4" sockets 4-4.5-5-5.5-6-7-8-9-10-11-12-13mm 1 pc 1/4" sockets adaptor 1 pc 1/4" extension bar 50mm 1 pc 1/4" sliding bar 1 pc 1/4" universal joint 50 pcs 1/4"x25 mm Bits 1 pc quick adaptor 60mm 9 pcs Combination wrench: 8/10/11/12/13/16/17/19/22MM.

15 PCS 3/4" SOCKETS SET

► In metal box



Item no.	Contents
20 90 50 01	3/4" driver Reversible ratchet 2pcs extension bar 10 pcs sockets: 22,24,27,30,32,36,38,41,46,50 mm 1 pc Sliding bar

21 PCS 3/4" DR.JUMBO HAND SOCKET SET



Item no.	Contents
20 99 00 19	16 pcs 3/4" socket 19-50mm 1 pc 3/4" ratchet handle 2 pcs extension bar 100,200mm 1 pc 3/4" sliding bar 456mm 1 pc blow mould case

SOCKET AND RATCHET HANDLE

26 PCS 3/4" & 1" DR. JUMBO HAND SOCKET SET



Item no.	Contents
20 99 00 20	17 pcs 3/4" socket 21-50mm 3 pcs 1" socket 55,60,65mm 1 pc 3/4" ratchet handle 2 pcs extension bar 200,520mm 1 pc 3/4" sliding bar 520mm 1 pc 3/4" universal joint 1 pc blow mould case

3 PCS 1/2" IMPACT SOCKET SET



Item no.	Contents
20 99 00 22	17,19,21mm with plastic cover

3 PCS 1/2" IMPACT SOCKET SET



Item no.	Contents
20 99 00 23	17,19,21mm

13 PCS 1/2" IMPACT SOCKET SET



Item no.	Contents
20 99 00 21	7/16", 1/2", 9/16", 5/8", 11/16", 3/4", 13/16", 7/8", 15/16", 1", 1-1/16", 1-1/8", 1-1/4"



1/4"X25MM BITS

- ▶ Forged Cr-V steel
- ▶ Hardened with sand blasting



Item no.	Contents
23 10 20 01	SL:3/4/5/5.5/6/7/8
23 10 20 02	PH:PH0/1/2/3/4
23 10 20 03	PZ:PZ0/1/2/3
23 10 20 04	Torx: T8/9/10/15/20/25/27/30/40/45
23 10 20 05	Torx with central hole: T8/9/10/15/20/25/27/30/40/45
23 10 20 06	Hex:H1.5/2/2.5/3/4/5/5.5/6
23 10 20 07	Hex with central hole: H2/2.5/3/4/5/5.5/6
23 10 20 08	X type:1/2/3/4
23 10 20 09	Y type:6/8/10
23 10 20 10	Open end: 4/6/8/10
23 10 20 11	Square:0/1/2/3

1/4"X50MM BITS WITH NECK

- ▶ Forged Cr-V steel
- ▶ Hardened with sand blasting



Item no.	Contents
23 15 20 01	SL:3,4,5,5.5,6,7,8
23 15 20 02	PH:PH0/1/2/3/4
23 15 20 03	Pz:PZ0/1/2/3
23 15 20 04	Torx:T8/9/10/15/20/ 25/27/30/40/45
23 15 20 05	Torx with hole:T8/9/10/15/ 20/25/27/30/40/45
23 15 20 06	Hex:H1.5/2/2.5/3/4/5/5.5/6
23 15 20 07	Hex with hole:H2/2.5/3/4/5/5.5/6

POWERFUL SOCKET

- ▶ Forged 50BV-30 steel
- ▶ Hardened, sand blasting with magnetic body



Item no.	Contents
20 30 40 03	6X42/45/48/65 7X42/45/48/65 8X42/45/48/65 9X42/45/48/65 10X42/45/48/65 11X42/45/48/65 12X42/45/48/65 13X42/45/48/65
20 90 20 01	10Pcs powerful socket set 4,5,5.5,6,7,8,9,10,11,12

POWERFUL SOCKET(WITH NECK)

- ▶ Forged Cr-V steel
- ▶ Hardened and sand blasting, with magnetic body



Item no.	Contents
20 30 40 01	4X34 5X34 5.5X36 6X36 7X36 8X36 9X36 10X38 11X38 12X38 13X38
20 90 40 02	10PCS POWERFUL SOCKET (Without NECK) 4,5,5.5,6,7,8,9,10,11,12

SOCKET BITS

- ▶ Made of Cr-V steel
- ▶ Hardened and chrome plated
- ▶ Length:37mm



Item no.	Contents
23 50 00 01	Slot:3/4/5.5/6.5/7/8 PH:PH0/1/2/3 PZ:PZ0/1/2/3 Torx:T8/10/15/20/25/27/30/40 Hex:H3/4/5/6/7/8 Square:S0/1/2/3

10PCS DOUBLE BIT SET

- ▶ Forged Cr-V steel
- ▶ Hardened and sand blasting
- ▶ WITH PLASTIC HOLDER,
- ▶ LENGTH OF BITS:65MM



Item no.	Contents
23 91 00 01	PH:1,2,3 PZ:1,2,3 SLOT:3,4,5,6

4PCS DOUBLE BIT SET

- ▶ Forged Cr-V steel
- ▶ Hardened and sand blasting
- ▶ With plastic holder,
- ▶ Length of bits:65mm



Item no. Contents

23 91 00 02	PH: PH0/1/2 Slot:5/6
-------------	-------------------------

49PCS BITS AND HOLDER SET

- ▶ Made of Cr-V steel, also can be made of S2 steel
- ▶ Bits are hardened and sand-blasting finished
- ▶ In plastic display holder and then in blister card



Item no. Contents

23 91 00 03	48pcs 25mm long bits: 2pcs Slotted bits: 5mm, 6mm 4pcs Slotted bits with central hole: 4mm, 6mm, 8mm, 10mm 4pcs PH bits: PH0, PH1, PH2, PH3 12pcs Hex bits with central hole: 2mm, 2.5mm, 3mm, 4mm, 5mm, 6mm, 5/64", 3/32", 7/64", 1/8", 9/64", 5/32" 4pcs PZ bits: PZ0, PZ1, PZ2, PZ3 9pcs Torx bits with central hole: T8H, T10H, T15H, T20H, T25H, T27H, T30H, T35H, T40H 4pcs 3-wing bits: 1, 2, 3, 4 3pcs 4-wing bits: 6, 8, 10 3pcs C bits: C1, C2, C3
23 91 00 04	3pcs Square bits: S1, S2, S3 1pc 1/4" female x 1/4" male magnetic bit holder

33 PCS BIT HOLDER SET

- ▶ Made of S2 steel, hardened, Grey phosphates.
- ▶ In plastic display holder and blister card



Item no. Contents

23 91 00 05	1/4" female x 1/4" male magnetic bit holder 3 x flat bits: 6, 8, 10 mm 4 x spanner bits: 4, 6, 8, 10 mm, 4 x tri-wing bits:1#, 2#, 3#, 4# 6 x hexagon bits: 2, 2.5, 3, 4, 5, 6 mm, 6 x hexagon bits: 5/32", 9/64", 1/8", 7/64", 3/32", 5/6" 9 x Tx-star bits:T8, T10, T15, T20, T25, T27, T30, T35, T40.
-------------	----------------------------------------------------------------------------------------------------------------------------------------------------------------------------------------------------------------------------------------------------------------------------------------------------------------------------

32PCS. PROFI - BIT SET, 75MM LONG

- ▶ High quality Cr-V steel
- ▶ With plastic holder



Item no. Contents

23 91 00 06	9 bits: T-8H,T-10H,T-15H,T-20H, T-25H,T-27H,T-30H,T-35H,T-40H, 3 bits: 6, 8, 10 mm 1 bits: 6 mm 6 bits: 2, 2.5, 3, 4, 5, 6 mm 4 bits: 1, 2, 3, 4 mm 2 bits: PH1, PH2 4 bits: 4, 6, 8, 10 mm 3 bits: PZ1, PZ2, PZ3
-------------	----------------------------------------------------------------------------------------------------------------------------------------------------------------------------------------------------------------------------------------

7 PCS BIT HOLDER SET

- ▶ Made of Cr-V steel, hardened, Grey phosphates.
- ▶ In round plastic transparent box and blister card



Item no. Contents

23 91 00 07	1/4" female x 1/4" male magnetic bit holder 2 x flat bits 4.5, 6.0 mm 2 x phillips bits: 1#, 2#. 2X pozi bits: 1#, 2#.
-------------	---------------------------------------------------------------------------------------------------------------------------------

31-IN-1 ELECTRIC FORGED CR-V STEEL

- ▶ Hardened with chrome plated



Item no. Contents

23 91 01 67	SL:1.0, 1.3, 1.5, 2.0, 2.5, 3.0, 4.0 PH:PH00,PH0,PH1,PH2 Torx:T3,T4,T5,T6,T7,T8,T10,T15 Hex:H1.5,H2,H2.5,H3,H3.5,H4 S:3.0,3.0,2.6,2.0,1.0
-------------	-------------------------------------------------------------------------------------------------------------------------------------------------------

16 PCS BIT HOLDER SET

- ▶ Made of Cr-V steel, hardened, Grey phosphates.
- ▶ In transparent plastic box and blister card



Item no. Contents

23 91 00 08	1/4" female x 1/4" male magnetic bit holder 3 x flat bits .5, 6, 7 mm 4 x phillips bits: 0#, 1#, 2# 3#. 4 x pozi bits: 0#, 1#, 2# 3#. 4 x Tx-star bits: T10, T20, T30, T40.
-------------	-----------------------------------------------------------------------------------------------------------------------------------------------------------------------------------------

8 PCS BITS SET



Item no. Contents

23 91 00 09	1pc L-type wrench; made of carbon steel,with chrome finished then rubber coated handle,length:105mm 7pcs 1/4"X25mm bits forged Cr-V steel, SIZES:T10,15,20,25,27,30,40
-------------	---------------------------------------------------------------------------------------------------------------------------------------------------------------------------------

9 IN 1 QUICK ADAPTOR AND BITS SET

- ▶ Packed in plastic box



Item no. Contents

23 91 00 11A	1pc quick-release chunk quick adaptor and universal bit holder 9pcs S2 bits:Hex 2.5mm,3.0mm,4.0mm,5.0mm,5.5mm Phillips PH0,PH1,PH2,PH3
23 91 00 11B	1pc quick-release chunk quick adaptor and universal bit holder 9pcs S2 bits: Pozidriv PZ1,PZ2,PZ3 Torx T10,T15,T20,T25,T30,T40

30PCS BITS BOX

- ▶ Packed in round plastic box with transparent cover



Item no.	Contents
23 91 00 12	18pcs 1/4"x25mm bits; forged carbon steel, hardened with matt finished size: Torx: T10/15/20/25/30 Pozi: PZ1/PZ2/PZ3 Hex: H2/2.5/3/4/5/6 PH: PH0/PH1/PH2/PH3 2pcs 1/4"x50mm bits with neck forged carbon steel, hardened with matt finished sizes: Slot: 5,7mm 7pcs Hex shaft powerful socket; sizes: 5/6/7/8/9/10/11 2pcs plastic guide 1pc 60mm magnetic adaptor

98PCS BITS SET

- ▶ Bits are Made of Cr-V steel, also can be made of S2 steel
- ▶ Hardened and sand-blasting finished
- ▶ Packed in blow mould case



Item no.	Contents
23 91 00 14	17pcs 75mm long bits: 2pcs Slotted bits: 5mm, 6mm 3pcs Square bits: S4, S5, S6 3pcs Torx bits: T15, T20, T30 4pcs Slotted bits with central hole: 4mm, 6mm, 8mm, 10mm 2pcs PH bits: PH1, PH2 3pcs 4-wing bits: 6, 8, 10

50PCS. BITS SET

- ▶ Packed in plastic box with transparent cover



Item no.	Contents
23 91 00 16	5pcs. slotted 3-4-5-6-7mm 5pcs. hexagon H2-3-4-5-6mm 9pcs. tx without hole t8-10-15-20-25-27-30-40-45 9pcs. tx with hole t8-10-15-20-25-27-30-35-40 8pcs. phillips 2xph0, 2xph1, 2xph2, 2xph3 4pcs. pozidrive pz0-1-2-3 4pcs. "tri wing" (y-type) 1-2-3-4 3pcs. "torque" (x-type) 6-8-10 3pcs. "spanner" (flat with hole) 6-8-10 1pc. quick release bit holder

100PCS. SPECIAL BIT SET

- ▶ Made of high-quality Cr-V-steel
- ▶ Including magnetic bit holder, adaptors, extension, and hook driver, 125mm long
- ▶ Packed in blow mould case



Item no.	Contents
23 91 00 13	100PCS

31PCS BIT SET

- ▶ Made of Cr-V steel, also can be made of S2 steel
- ▶ Bits are hardened and sand-blasting finished
- ▶ Packed in plastic box



Item no.	Contents
23 91 00 15	30pcs 25mm long bits: 3pcs PH bits: PH1, PH2, PH3 4pcs PZ bits: PZ1, PZ2 x 2pcs, PZ3 4pcs Slotted bits: 3mm, 4mm, 5mm, 6mm 4pcs Hex bits: 3mm, 4mm, 5mm, 6mm 7pcs Torx bits: T10, T15, T20, T25, T27, T30, T40 7pcs Torx bits with central hole: T10H, T15H, T20H, T25H, T27H, T30H, T40H 1pc 60 mm magnetic bit holder

32PCS BITS SET

- ▶ Packed in plastic box with transparent cover



Item no.	Contents
23 91 00 17	30pcs 25mm screwdriver bits 4pcs phillips: ph1, ph2x2, ph3 4pcs pozi: pz1, pz2*2, pz3 4pcs slotted: sl3, sl4, sl5, sl6 4pcs hexagon: h3, h4, h5, h6 7pcs torx: t10, t15, t20, t25, t27, t30, t40 7pcs tamper torx: t10, t15, t20, t25, t27, t30, t40 1pc 25mm adaptor 1pc quick change holder

18PCS BIT COMBINED TOOL

► Packed in plastic box



Item no.	Contents
23 91 00 18	1pc bit elastic holder 17pcs 25mm Cr-V bits: SL: 3, 4, 5, 6, 7mm PH: 0, 1, 2, 3 PZ: 1, 2, 3 Torx: 10, 15, 20, 25, 30

45PCS BIT SET

► Packed in plastic box



Item no.	Contents
23 91 00 19	32pcs 25mm Cr-V bits SL:4,5,6,7mm Square: 0,1,2,3 PH: 0,1,2,3 PZ:0,1,2,3 Hex: 1.5, 2, 2.5, 3, 4, 5, 5.5, 6mm Torx: 8, 10, 15, 20, 25, 27, 30, 40 4pcs 50mm Cr-V bit: Hex: 3, 4mm Torx: 15, 20 8pcs 65 mm double end Cr-V bit: SL4-SL4, SL5-SL5, SL6-SL6, PH2-PH2(X3), SL4-PH1, SL5-PH2 1pc 60mm magnetic bit holder

41 PCS BIT SET

► High quality Cr-V steel
► Packed in blow mould case



Item no.	Contents
23 91 00 20	9pcs 1/4"X50mm bits Slot:5,6mm PH:1,2,3 Torx:T10,15,20,25 1pc 60mm magnetic adaptor 20pcs 1/4"X25mm bits: sizes:Slot:3,4,5,6 PH:0,1,2,3; Torx:T8,T9,T10,T15,T20,T25,T27 HEX:2,5,3,4,5,6mm 7pcs powerful sockets 5,6,7,8,9,10,11 3pcs HSS drills ;2,5,3,4mm 1pc quick adaptor

49-PCS. SOCKET AND BIT SET

► Packed in oval blow mould case



Item no.	Contents
23 91 00 21	16pcs. 50 mm long bits in Cr-V steel 5pcs. 65 mm long Double Head Long Bits in Cr-V steel 20pcs. 25 mm long bits in Cr-V-steel, 1pc. Magnetic Bit Holder, 7pcs. Power Sockets with Bit Shank in Cr-V-steel.

113PCS. 1/4" BITS SET

► All the bits are made of Cr-V or S2 material
► Packed in blow mould case



Item no.	Contents
23 91 00 22	21pcs phillips, 25mm: each 7pcs for ph1, ph2 and ph3; 21pcs. pozidrive, 25mm: each 7pcs for pz1, pz2 and pz3; 14pcs. slotted: 25mm: each 7pcs for 4mm and 6mm; 21pcs. hexagon, 25mm: each 7pcs for 4mm, 5mm and 6mm; 14pcs. tx without hole, 25mm: each 2pcs for t10, t15, t20, t25, t27, t30 and t40; 7pcs. tx with hole, 25mm: t10, t15, t20, t25, t27, t30 and t40; 3pcs. hexagon, 90mm: ph2; 3pcs. pozidrive, 90mm: pz2; 7pcs. tx, 90mm: t10-t15-t25-t30 and 3pcs of t20; 1pc bit holder, 60mm; 1pc quick release bit holder

32-PCS DRILL + BIT SET

► Packed in opened blow-mould-case in double blister



Item no.	Contents
23 91 00 23	5pcs. hex shank hss twist drills (1.5-2.0-3.0-4.0-5.0 mm) 8pcs. crv-bits 25 mm (sl4-5-6,ph1-2-3,pz1-2) 8pcs.crv-bits 50 mm) (sl4-5-6, ph 1-2-3,pz1-2) 2pcs.crv-bits 75 mm (sl6,ph2) 1pc. quick release bit holder 60 mm 1pc.magnetic bit holder 75 mm with protection tube 6 hex shank sockets (40cr) (5-6-7-8-9-10mm) 1 countersink



37PCS BIT TOOL SET

- ▶ Bits are Made of Cr-V steel, also can be made of S2 steel
- ▶ Hardened and sand-blasting finished
- ▶ Packed in plastic box



Item no.	Contents
23 91 00 24	2pcs 75mm long bits: PH2, Slotted 5mm 8pcs 65mm long double end bits: Slotted 4mm, Slotted 5mm, Slotted 6mm, PH1,PH2, PH3, PZ1, PZ2 24pcs 25mm long bits: 4pcs Torx bits: T10, T15, T20, T25 4pcs Slotted bits: 3mm, 4mm, 5mm, 6mm 4pcs Hex bits: 3mm, 4mm, 5mm, 6mm 4pcs Square bits: S0, S1, S2, S3 4pcs PH bits: PH0, PH1, PH2, PH3 4pcs PZ bits: PZ0, PZ1, PZ2, PZ3 1pc 75mm magnetic bit holder 1pc magnetic extension bit holder 1pc magnetic quick adaptor

41PCS BITS AND DRILL SET

- ▶ Packed in a plastic case



Item no.	Contents
23 91 00 25	24pcs 1/4"X25mm CRV bits,satin finished 1pc quick adapter 15pcs HSS roll-forged drill, hex shaft,titanium coated

65PCS BITS AND DRILL SET

- ▶ Packed in a bi-color plastic case



Item no.	Contents
23 91 00 26	48pcs 1/4"X25mm Cr-V bits 15pcs 1/4"X50mm Cr-V bits,satin finished 1pc quick adaptor

65PCS BITS AND DRILL SET

- ▶ Packed in double blister with a plastic box



Item no.	Contents
23 91 00 27	21pcs CRV bits, SL:3-4-5-6-7 PH:2XPH0,2XPH1,2XPH3. Hex:3mm,4mm,5mm,6mm, Torx:T15,T20,T25,T27 2pcs 50mm Cr-V long bits:PH2,S16 2pcs Hex shank sockets:6mm,8mm. 1pc magnetic bit holder with protection tube

61 PCS DRILL AND BIT SET

- ▶ Packed in blow mould box+double blister



Item no.	Contents
23 91 00 28	16 HSS drill: 2x1.5mm, 2mm, 2x2.5mm, 3mm, 2x3.2mm, 3.5mm, 4mm, 4.5mm, 4.8mm, 5mm, 5.5mm 6mm, 6.5mm 5 Wood drill: 3mm, 4mm, 5mm, 6mm, 8mm. 24 Cr-V bits 25mm 3 Cr-V bits 50mm 1 Cr-V Countersink 7 Cr-V sockets 3 Stopper 1PC blowcase with scale

27PCS SOCKET AND BIT SET

- ▶ 18pcs 65mm long bits manufactured from Cr-V steel;
- ▶ 6pcs power sockets with bit shrank in Cr-V steel, sand blasting finish;
- ▶ 1pc 60mm long magnetic bit holder, with 1pc anti-slip handle, double components TPR soft grip for comfortable holding, also the bits could insert into the holder in the middle of the handle, could be used as T handle for easy getting high torque.
- ▶ Packed in double blister card.



Item no.	Contents
23 91 00 29	18pcs 65mm long bits: SL: 3, 4, 5, 6, 7mm PH:0, 1, 2, 3 PZ:1,2,3 Torx:T10,T15,T20,T25,T30,T40 6pcs power sockets with bit shank: 5mm, 6mm, 7mm, 8mm, 9mm, 10mm. 1pc 60mm magnetic bit holder. 1pc 155mm ratchet handle. 1pc strong nylon bag.

43PCS SOCKET AND BIT SET

- ▶ Packed in double blister card



Item no.	Contents
23 91 00 30	1pc 1/4" ratchet handle 1pc soft shaft 27pcs 1/4"X25mm bits: PZ:#0,1,2,3 hex:2,2.5,3,4,5,5.5,6 Torx:T10,15,20,25,27,30,40 Slot:3,4,5,6,7 Socket: metric:5.6.7.8.9.10.11mm SAE:3/16",1/4",9/32",1/32",5/16",3/8",7/16"

101PCS DRIVER AND BIT SET

- ▶ Screw ratchet handle with reversible direction and non-slip coating
- ▶ 84 Bits made of high class toolsteel, suitable for electric drills
- ▶ 11 Sockets made of high class tool steel, chrome plated
- ▶ Packed in blow mould box with window



Item no.	Contents
23 91 00 31	101PCS

84PCS DRIVER AND BIT SET

- ▶ Screw ratchet handle with reversible direction and non-slip coating
- ▶ 84 Bits made of high class toolsteel, suitable for electric drills
- ▶ 11 Sockets made of high class tool steel, chrome plated
- ▶ Packed in blow mould box with window



Item no.	Contents
23 91 00 32	1pc flexible ratchet handle
	22pcs 1/4" sockets
	6pcs 1/4"x50mm bits
	53pcs 1/4"x25mm bits
	1pc 60mm magnetic adaptor
	1pc 50mm square and hex adaptor

102PCS BIT SET

- ▶ Packed in aluminum case



Item no.	Contents
23 91 00 33	95pcs 25mm Cr-V bits
	1pc 25mm Cr-V adaptor
	1pc 50mm Cr-V adaptor
	1pc socket driver adaptor
	1pc magnetic bit holder
	1pc hook driver
	1pc ratchet screwdriver
	1pc T handle

75PCS BITS SET

- ▶ Made of Cr-V steel, also can be made of S2 steel
- ▶ Bits are hardened and sand-blasting finished
- ▶ In EVA inner tray and then in metal box



Item no.	Contents
23 91 00 34	15pcs 80 mm long bits: 3pcs Torx bits: T10, T15, T20 2pcs Hex bits: H4, H5 3pcs Slotted bits with central hole: 4mm, 6mm, 8mm 2pcs PH bits: PH1, PH2 2pcs Slotted bits: 3mm, 5.5mm 3pcs 3-wing bits: 1, 2, 3
	55pcs 25 mm long bits: 8pcs Torx bits with central hole: T8H, T10H, T15H, T20H, T25H, T27H, T30H, T40H, 4pcs PH bits: PH0, PH1, PH2, PH3 4pcs PZ bits: PZ0, PZ1, PZ2, PZ3 6pcs Hex bits: 5/64", 3/32", 1/8", 5/32", 3/16", 1/4" 6pcs Slotted bits: 3mm, 4mm, 5mm, 6mm, 7mm, 8mm 4pcs 3-wing bits: 1, 2, 3, 4 6pcs Hex bits with central hole: 2mm, 2.5mm, 3mm, 4mm, 5mm, 6mm 3pcs 4-wing bits: 6, 8, 10 4pcs Square bits: S0, S1, S2, S3 3pcs C bits: 1, 2, 3 7pcs Torx bits: T8, T10, T15, T20, T25, T30, T40
	1pc 25mm bit adaptor
	1pc bit driver with double color handle
	1pc 60 mm magnetic bit holder
	1pc 1/4" Dr socket adaptor
	1pc hook driver

59PCS SOCKET + BIT SET

- ▶ Packed in metal case



Item no.	Contents
23 91 00 35	1pc bit driver, with 2 components handle.

121PCS SOCKET + BIT SET

- ▶ Packed in blow mould case



Item no.	Contents
23 91 00 36	20pcs Cr-V extra sockets: 4, 5, 6, 7, 8, 9, 10, 11, 12, 13mm 5/32", 3/16", 7/32", 1/4", 9/32", 5/16", 11/32", 3/8", 7/16", 1/2"
	79pcs 25mm Cr-V bits Square: S0, S1, S2, S3 SL: 3, 4, 4.5, 5, 5.5, 6, 6.5, 7, 8mm PH: 0, 1, 2(x5), 3, PZ: 0, 1, 2(x5), 3, SL with central hole: 4, 6, 8, 10mm M: 5, 6, 8 Torx: 8, 10, 15, 20, 25, 27, 30, 40, 45, Hex: 1.5, 2, 2.5, 3, 4, 5, 5.5, 6, 7 5/32", 3/16", 7/32", 1/4" Torx with central hole: 8, 10, 15, 20, 25, 27, 30, 35, 40 Hex with central hole: 2.2, 2.5, 3, 4, 5, 6, 5/32", 9/64", 1/8", 7/64", 3/32", 5/64"
	1pc 100mm 2 components TPR handle handle, with Cr-V steel blade
	1pc hook driver
	1pc socket adaptor 1/4" Dr
	1pc 25mm Cr-V bit adaptor
	1pc 50mm Cr-V bit adaptor
	1pc 60mm magnetic bit holder

20-IN-1 SCREWDRIVER SET

- ▶ Double color handle can be used like normal screwdriver, also can be used as T type Handle
- ▶ Bits are hardened and satin finished
- ▶ Packed in blow mould case



Item no.	Contents
23 91 00 37	10pcs 175mm long double end Cr-V bits: Ball point hex 6mm + Hex 6mm, Ball point hex 5mm + Hex 5mm, Ball point hex 4mm + Hex 4mm, T10 + T15, T20 + T25, T30 + T40, PH1 + PH2 X 2pcs, Slotted 5mm + Slotted 7mm, Slotted 4mm + Slotted 6mm
	1pc double color handle



16PCS DOUBLE END SCREWDRIVERS SET

► Made of Cr-V steel, hardened and nickel plated, magnetic tips



Item no.	Contents
23 91 00 38	6pcs 1/4"X150mm double end hex blades 8pcs 4X120mm double end hex blades 2pcs PP/TPR bi-color screwdriver handle

155PCS BIT SET

► Packed in aluminum case + double blister



Item no.	Contents
23 91 00 39	13pcs 50mm Cr-V bit Hex: 2, 2.5, 3, 4, 5, 6mm Torx: 10, 15, 20, 25, 27, 30, 40 13pcs 75mm Cr-V bits: SL with central hole: 4(x5) PH: 2(x3) Torx: T20(x5) 25mm Cr-V bits SL: 3, 4, 4.5, 5, 5.5, 6, 6.5, 7, 8mm, 3/32", 7/64", 1/8", 9/64", 5/32", 3/16", 7/32", 1/4", 9/32" Hex: 1.5, 2, 2.5, 3, 4, 5, 5.5, 6, 8mm, 1/16", 5/16", 3/32", 7/64", 1/8", 9/64", 5/32", 3/16", 7/32", 1/4", PH: 0, 1(x2), 2(x10), 3(x2) PZ: 0, 1(x2), 2(x10), 3(x2) C: 1, 2, 3 M: 5, 6, 8 Square: 0, 1, 2, 3 3-wing: 1, 2, 3, 4 4-wing: 6, 8, 10 SL-with central hole: 4, 6, 8, 10 Torx: 7, 8, 9, 10, 15, 20, 25, 27, 30, 35, 40, 45 Torx with central hole: 7, 8, 9, 10, 15, 20, 25, 27, 30, 35, 40 Hex with central hole: 2, 2.5, 3, 4, 5, 6 5/64", 3/32", 7/64", 1/8", 9/64", 5/32" 1pc 25 mm bit adaptor 1pc 1/4"Dr socket adaptor 1pc 60mm magnetic bit holder 1pc 50mm bit adaptor 1pc 1/4" dr ratchet spanner 1pc stubby bit driver with 2 components handle

147PCS BIT SET

► Packed in aluminum case + double blister



Item no.	Contents
23 91 00 40	12pcs 50mm Cr-V bit Hex: 2, 2.5, 3, 4, 5, 6mm Torx: 10, 15, 20, 25, 30, 40 13pcs 75mm Cr-V bits: SL: 6 mm PH: 2(x2) Hex:: 2, 3, 4, 5, 6mm Torx: T10, T15, T20, T25, T30 25mm Cr-V bits SL: 3, 4, 4.5, 5, 5.5, 6(X3), 6.5, 7, 8mm, PZ: 0, 1(x2), 2(x10), 3(x3) PH: 0, 1(x2), 2(x10), 3(x2) Torx: 7, 8, 9, 10, 15, 20, 25, 27, 30, 40, 45 Hex: 1.5, 2, 2.5, 3, 4, 5, 5.5, 6, 8, 1/16", 5/64", 3/32", 7/64", 1/8", 9/64", 5/32", 3/16", 7/32", 1/4" Square: 0, 1, 2, 3 3-wing: 1, 2, 3, 4 4-wing: 6, 8, 10 C: 1, 2, 3 M: 5, 6, 8 SL-with central hole: 4, 6, 8, 10 Hex with central hole: 2, 2.5, 3, 4, 5, 6 mm 5/64", 3/32", 7/64", 1/8", 9/64", 5/32" 1pc 25 mm bit adaptor 1pc hook driver 1pc 1/4"Dr socket adaptor 1pc 60mm magnetic bit holder 1pc T-handle bit driver with 2 components handle 1pc T-handle ratchet driver



44 PCS LIGHTED BIT DRIVER SET

► Packed in double blister card



Item no.	Contents
23 91 00 41	1x lighted bit driver, powered by 2 AAA batteries (batteries not included) 12 x 1/4" sockets : 3/16", 1/4", 5/16", 3/8", 7/16", 1/2", 5/32", 3/16", 1/4", 5/16", 3/8", 1/532" 2pcs sockets holder 26pc 25mm bits: 4 x PH: 0#, 1#, 2#, 3#. 4 x Flat: 1/8", 3/16", 1/4", 5/16", 3 x Torx T10, T25, T30, 2 x squares: S1, S2. 12 x Hex: 3/32", 1/8", 5/32", 3/16", 7/32", 1/4", 5/64", 3/32", 1/8", 5/32", 3/16", 1/4", 1 x 1/4" socket adapter 1pc 12" Flexible shaft, bit extension with magnetic tip

22-PCS.BITS SET



Item no.	Contents
23 91 00 42	1pc T-handle 1pc 1/4" square and hex magnetic sockets 11pcs bits: PH: 1, 2, 3. Torx: T15, 20, 30. Slot: 3, 4, 5, 6, 8 9pcs 1/4" sockets: H5+H6+H7+H8+H9+H10+H11+H12+H13

SCREWDRIVERS,
BITS AND HEXAGON KEYS

36PCS SOCKET AND BIT SET

► Packed in double blister card



Item no.	Contents
23 91 00 43	1pc 2 components non-slip T handle 25pcs 25mm Cr-V bits: SL: 3, 4, 5, 6, 7mm PH: 0, 1, 2, 3 PZ: 0, 1, 2, 3 HEX: 2, 3, 4, 5, 5.5, 6mm TORX: 10, 15, 20, 25, 30, 40 9 sockets: 5, 6, 7, 8, 9, 10, 11, 12, 13mm 1pc 1/4" bit adaptor

28PCS BIT AND SOCKET SET

- Bits are Made of Cr-V steel, also can be made of S2 steel
- Hardened and sand-blasting finished
- Sockets are made of high carbon steel, and chrome plated
- Packed in plastic box



Item no.	Contents
23 91 00 44	8pcs sockets: 5mm, 6mm, 7mm, 8mm, 9mm, 10mm, 11mm, 12mm 17pcs 25mm long bits: 3pcs PH bits: PH1, PH2, PH3 3pcs PZ bits: PZ1, PZ2, PZ3 5pcs Torx bits: T10, T15, T20, T25, T30 3pcs Hex bits: 3mm, 4mm, 5mm 3pcs Slotted bits: 4mm, 5mm, 6mm 1pc 25mm bit adaptor 1pc magnetic quick adaptor 1pc 1/4"Dr ratchet spanner

38PCS BIT SET

► Packed in aluminum case



Item no.	Contents
23 91 00 45	36pcs CRV bits, Torx: T10-15-20-25-27-30-40 Torx with hole: T10-15-20-25-27-30-40 PH: 2xPH1, 2xPH2, 2xPH3 PZ: 2xPZ1, 2xPZ2, 2xPZ3 SL: 1/8"-5/32"-3/16"-1/4" HEX: 5/64"-3/32"-1/8"-5/32"-3/16"-1/4" 1pc magnetic bit holder 1pc 1/4" ratchet spanner

100PCS BIT SET

► Packed in plastic box with transparent cover



Item no.	Contents
23 91 00 46	97pcs 1/4"x25mm Cr-V bits set 1pc 1/4"x25mm Y-type adaptor 1pc 1/4"x25mm square to hex adaptor 1pc 1/4"x60mm magnetic adaptor 1pc double color plastic case

38PCS BIT AND SOCKET SET

► Packed in plastic box with transparent cover



Item no.	Contents
23 91 00 47	26pcs 1/4"x25mm Cr-V bits 9pcs Cr-V sockets, satin chrome plated: Specification: 5-13mm 1pc 1/4"x75mm adaptor, Forged carbon steel, hardened with chrome plated 1pc stubby ratchet handle 1pc 1/4"x25mm adaptor 1pc double color plastic case

79PCS BIT SET

► Packed in double blister card



Item no.	Contents
23 91 00 48	78pcs 1/4"x25mm Cr-V bits 1pc stubby ratchet bit driver 1pc double color plastic case

99PCS BIT TOOL SET

- Bits are Made of Cr-V steel, also can be made of S2 steel
- Hardened and sand-blasting finished
- Packed in blow mould case



Item no.	Contents
23 91 00 49	95pcs 25mm long bits: 8pcs PH bits: PH0, PH1, PH2 x 5pcs, PH3 8pcs PZ bits: PZ0, PZ1, PZ2 x 5pcs, PZ3 3pcs M bits: M5, M6, M7 3pcs C bits: C1, C2, C3 9 Pcs Slotted bits: 3mm, 4mm, 4.5mm, 5mm, 5.5mm, 6mm, 6.5mm, 7mm, 8mm 4pcs Square bits: S0, S1, S2, S3 4pcs Slotted bits with central hole: 4mm, 6mm, 8mm, 10mm 3pcs 4-wing bits: 6, 8, 10 4pcs 3-wing bits: 1, 2, 3, 4 9pcs Trox bits: T8, T10, T15, T20, T25, T27, T30, T40, T45 19pcs Hex bits: 1.5mm, 2mm, 2.5mm, 3mm, 4mm, 5mm, 5.5mm, 6mm, 8mm 1/16", 5/64", 3/32", 7/64", 1/8", 9/64", 5/32", 3/16", 7/32", 1/4" 9pcs Torx bits with central hole: T8H, T10H, T15H, T20H, T25H, T27H, T30H, T35H, T40H 12pcs Hex bits with central hole: 2mm, 2.5mm, 3mm, 4mm, 5mm, 6mm, 5/64", 3/32", 7/64", 1/8", 9/64", 5/32" 1pc double color stubby bit driver 1pc 1/4"Dr ratchet spanner



35PCS BITS AND SOCKETS SET

- ▶ Professional quality,manufactured from S2 steel,expert hardened ,tempered.bits fully sand blasting for corrosion protection.
- ▶ Packed in plastic case



Item no.	Contents
23 91 00 50	17pcs 25mm S2 bits: PH:PH1,PH2,PH3, PZ:PZ1,PZ2,PZ3, SL:3mm,4mm,5mm,6mm Torx:10-15-20 HEX:4-5-6 9pcs 90mm S2 bits: PH:1-2 PZ:PZ1,2xPZ2,PZ3, HEX:3-4-5 1pc adaptor socket 1pc bit driver,with 2 components handle 8pcs sockets: 5mm,6mm,7mm, 8mm,9mm,10mm,11mm,12mm

50PCS BIT SET

- ▶ Professional quality,manufactured from S2 steel,expert hardened ,tempered.bits fully sand blasting for corrosion protection.
- ▶ Packed in plastic case



Item no.	Contents
23 91 00 52	40pcs 25mm S2 bits: PH:2XPH0,2XPH1,2XPH2,2XPH3, PZ:2XPZ0,2XPZ1,2XPZ3, HEX: 3mm, 4mm, 5mm, 6mm Torx:10-15-20-25-30-40 Torx with hole:10-15-20-25-30-40 SL:3mm,4mm,5mm,6mm 9pcs 90mm S2 bits:PH2-3 Torx:10-15-20-25-27-30-40 1pc magnetic quick adaptor

19PCS DRILL SET

- ▶ Din 338,High speed steel,straight shank,titanium coated for long life
- ▶ Packed in double blister with a plastic box



Item no.	Contents
23 91 00 54	1.5,2,2.5,3,3.2,3.5,4,4.5,4.8,5,5.5,6,6.5,8,10

43PCS BIT SET

- ▶ Professional quality,manufactured from S2 steel,expert hardened ,tempered.bits fully sand blasting for corrosion protection.
- ▶ Packed in plastic case



Item no.	Contents
23 91 00 51	18pcs 25mm S2 bits: PH:PH0,PH1,PH2, 2XPH3, PZ:PZ0,PZ1,PZ2,PZ3. SL:3mm,2X4mm,5mm,2X6mm HEX:3mm,4mm,5mm,6mm Torx:T10-T15-T20-T25-T27-T30-T40 Torx with hole:T10-T15-T20-T25-T27-T30-T40 9pcs 90mm S2 bits: PH:1-2 PZ:Pz1,2XPZ2,PZ3 HEX:3-4-5 1pc bit driver,with 2 components handle

62PCS BIT SET

- ▶ Professional quality,manufactured from S2 steel,expert hardened ,tempered.bits fully sand blasting for corrosion protection.
- ▶ Packed in plastic case



Item no.	Contents
23 91 00 53	60pcs 25mm bits PH:3XPH0,3XPH1,2XPH2,2XPH3, PZ:3XPZ0,3XPZ1,3XPZ2,3XPZ3 SL:3mm,2X4mm,5mm,2X6mm Hex:2X3mm,2X4mm,2X5mm,3X6mm Torx:3XT10,3XT15,3XT20, 3XT25,3XT27,3T30,3X40X 1pc bit holder,60mm 1pc quick release bit holder

30 - IN - 1 SCREWDRIVER BIT SET

- ▶ Packed in metal box



Item no.	Contents
23 91 00 55	1pc precision handle with swivel end.

15-PCS.SPEICAL DRIVER SET

- ▶ For t- screws, all parts made of Cr-V,
- ▶ Packed in blow-mould-case ,



Item no.	Contents
23 91 00 56	7pcs 30 mm bits sizes 20-25-30-40-45-50-55 7pcs 75 mm bits sizes 20-25-30-40-45-50-55 1pc adaptor 1/2" with ball x 10 mm

36PCS MECHANICS BITS SET

► Packed in blow-mould-case ,



Item no.	Contents
23 91 00 60	21pcs 30MM H10 BITS: HEX:4,5,6,7,8,10,12 TORX:20,25,27,30,35,40,45,50,55 M:5,6,8,10,12 12pcs 75MM H10 BITS: M:5,6,8,10,12 HEX:4,5,6,7,8,10,12 2pcs BITS HOLDER: 1/2"X35MM,3/8"X25MM 1pc REVERSIBLE RATCHET HANDLE,WITH TRP GRIPS

42PCS MECHANISM BITS SET

► Packed in metal case



Item no.	Contents
23 91 00 57	Hex: H4, H5, H6, H7, H8, H10, H12mm M: M6, M8, M10, M12 Torx: T20, T25, T30, T40, T45, T50, T55, T60. 20pcs Cr-V 75mm H10 bits: Hex: H4, H5, H6, H7, H8, H10, H12mm M: M6, M8, M10, M12 Torx: T20, T25, T30, T40, T45, T50, T55, T60 2pc Cr-V bit adaptor 1/2"Dr X 10mm, 3/8"DrX10mm

40PCS MECHANISM BITS SET

► Packed in metal case.



Item no.	Contents
23 91 00 58	19pcs Cr-V steel 30mm H10 bits: Hex:4-5-6-7-8-10-12mm, M:5-6-8-10-12, Torx:T20-T25-T30-T40-T45-T50-T55 19pcs Cr-V steel 75mm H10 bits: Hex:4-5-6-7-8-10-12mm, M:5-6-8-10-12, Torx:T20-T25-T30-T40-T45-T50-T55 2pcs Cr-V bit adaptor, chrome plated, 1/2"Dr X 10mm,3/8"DrX10mm

40PCS. POWER BIT SET

► Packed in blow-mould-case ,



Item no.	Contents
23 91 00 59	2pcs 3/8" & 1/2"adaptors;forged Cr-V steel,hardened,polished then chrome plated surface 19pcs 10H bits;forged Cr-V steel, hardened with matt finished surface. 30MM Hex bits:H4/H5/ H6/H7/H8/H10/H12 75MM Torx bits:T20 / T25 /T30 /T40 /T45 /T50 /T55

22PCS MECHANISM BITS SET

► Packed in metal case.



Item no.	Contents
23 91 00 61	10pcs Cr-V steel 30mm H10 bits, T20-T25-T27-T30-T35- T40-T45-T50-T55-T60 10pcs Cr-V steel 75mm H10 bits T20-T25-T27-T30-T35- T40-T45-T50-T55-T60 2pcs Cr-V bit adaptor, chrome plated,1/2"Dr X 10mm,3/8"DrX10mm

11PCS MECHANISM BITS SET

► Made of Cr-V steel, also can be made of S2
steel
► Bits are hardened and sand-blasting finished
► In EVA inner tray and the in metal box



Item no.	Contents
23 91 00 62	5pcs 30 mm long M bits: M5, M6, M8, M10, M12 5pcs 75 mm long M bits: M5, M6, M8, M10, M12 1pc Cr-V bit adaptor 1/2"Dr x 10 mm

9-IN-1 PRECISION SCREWDRIVER BIT SET

► Packed in double blister card



Item no.	Contents
23 91 00 63	1pc stubby aluminum screwdriver handle 3pcs PH:PH00,PH0,PH1 3pcs SL:1mm,1.5mm,2mm 3pcs Torx:T6,T7,T8

20PCS BIT SET

► Packed in double blister card



Item no.	Contents
23 91 00 64	16pcs bits: SL:1.5mm,2.0mm,2.5mm,3.0mm PH:#000,#00,#0,#1 Star:T4,T5,T6,T7 Hex:0.7mm,0.9mm,1.3mm,1.5mm 4pcs aluminum bit holder

SCREWDRIVERS,
BITS AND HEXAGON KEYS



32PCS PRECISION SCREWDRIVER SET

► Packed in plastic box with window



Item no.	Contents
23 91 00 66	1pc 2 components PP/TPR handle 1pc 4X110mm bit holder. Cr-V chrome plated 30pcs 4X28mm bits Cr-V nickle plated 7Xflat bits:1.0/1.5/2.0/2.5/3.0/3.5/4 4Xphillips bits:PH000/PH00/PH0/PH1 2Xpozi bits:PZ0/PZ1 9Xtorx bits:T4/T5/T6/T7/T8/T9/T10/T15/T20 8Xhex bits:0.7/0.9/1.3/1.5/2.0/2.5/3.0/4

31PCS PRECISION SCREWDRIVER SET

► All of bits are made of Cr-V 6150
► Packed in transparent plastic box



Item no.	Contents
23 91 00 67	1pc 2 components screwdriver handle 1pc stainless steel nippers with straight tips 4pcs Phillips:PH00,PH0,PH1,PH2 6pcs slotted :1/6",5/64", 3/32",1/8",9/64",5/32" 8pcs Torx:T4,T5,T6,T7,T8,T10,T15,T20 7pcs Hex key :1.0mm,1.3mm, 1.5mm,2.0mm,2.5mm,3.0mm,4.0mm

36PCS PRECISION SCREWDRIVER BITS SET

► Packed in plastic box with transparent card



Item no.	Contents
23 91 00 68	34pcs 4x28mm Cr-V bits nickle plated 1pc 4X115mm adaptor 1pc 2 components handle 1pc double color plastic case

21PC DRILL AND DRIVER SET

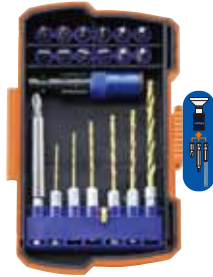

Item no.	Contents
23 91 00 69	13pc. 25mm driver bits 6pc. Titanium hex shank drill bits 1pc. 2-in-1 Connector 1pc. Magnetic bit holder

39PC. POWER-TORQUE IMPACT DRIVER SET



Item no.	Contents
23 91 00 70	24pc. S2 driver bits, 25mm 8pc. S2 driver bits, 50mm 4pc. Nutsetters, 2pc. Socket adaptors 1pc. Magnetic bit holder

8PC. QUICK CHANGE DRIVER SET



Item no.	Contents
23 91 00 71	4pc. 25mm driver bits 3pc. 50mm driver bits 1pc. 2-in-1 Connector

50PC. DRILL AND DRIVER SET



Item no.	Contents
23 91 00 72	26pc. S2 driver bits, 25mm 9pc. S2 driver bits, 50mm 3pc. Nutsetters, 2pc. Socket adaptors 7pc. Titanium hex shank drill bits 1pc. Magnetic bit holder 1pc. Magnetic finder driver, 1pc. 2-in-1 Connector

55PC. DRILL AND DRIVER SET



Item no.	Contents
23 91 00 73	32pc. S2 driver bits, 25mm 11pc. S2 driver bits, 50mm, 3pc. Nutsetters 7pc. Titanium hex shank drill bits 1pc. 2-in-1 Connector 1pc. Magnetic bit holder

42PC. POWER-TORQUE IMPACT SET



Item no.	Contents
23 91 00 74	24pc. S2 driver bits, 25mm 12pc. S2 driver bits, 50mm 4pc. Long sockets 1pc. Impact magenetic bit holder 1pc. Socket adaptor

SCREWDRIVERS,
BITS AND HEXAGON KEYS

54PC. QUICK CHANGE DRIVER BITS SET



Item no.	Contents
23 91 00 75	32pc. 25mm driver bits, 13pc. 50mm driver bits 3pc. 75mm driver bits, 4pc. Nutsetters 1pc. High-Torque magnetic bit holder 1pc. Quick change connector

47PC. POWER DRIVING SET



Item no.	Contents
23 91 00 78	32pc.25mm driver bits 10pc.50mm driver bits 3pc. Nutsetters 1pc.Adaptor 1pc.Magnetic bit holder

31PC. SCREWDRIVER BITS SET



Item no.	Contents
23 91 00 81	21pc. 25mm driver bits 9pc. 60mm double head driver bits 1pc. Magnetic bit holder

54PC. POWER DRIVING SET



Item no.	Contents
23 91 00 76	33pc. 25mm driver bits 9pc. 50mm driver bits 3pc. 75mm driver bits 7pc. Nutsetters 1pc. Magnetic bit holder 1pc. Quick change connector

40PC. SCREWDRIVER BITS SET



Item no.	Contents
23 91 00 79	35pc. 25mm driver bits 4pc. 90mm driver bits 1pc. Magnetic bit holder

18PC.90MM LONG DRIVER BITS SET



Item no.	Contents
23 91 00 82	PH: PH1-PH2X2-PH3 Tx:T10-T15-T20-T25-T27-T30-T40 PZ:PZ1-PZ2X2-PZ3, HEX:3-4-5

20PC. SCREWDRIVER BITS SET



Item no.	Contents
23 91 00 80	17pc. 50mm driver bits 3pc. Socket adaptor

71PC.DRIVER BITS SET



Item no.	Contents
23 91 00 83	60pc.25mm driver bits, SL:3.0-4.0X2-5.0-6.0X2 PH: PH0X3-PH1X3-PH2X3-PH3X3 PZ:PZ0X3-PZ1X3-PZ2X3-PZ3X3 Tx:T10X3-T15X3-T20X3-T25X3-T27X3-T30X3-T40X3 HEX:3.0X2-4.0X2-5.0X2-6.0X3, 9pc. 90mm driver bits, PH: PH2-PH3, Tx:T10-T15-T20-T25-T27-T30-T40 1pc. Magnetic bit holder, 1pc. Quick change magnetic bit connector

83PC. HEX SHANK DRILL AND DRIVER SET



Item no.	Contents
23 91 00 77	14pc.Titanium hex shank drill bits 33pc. 25mm driverr bits, 16pc. 50mm driverr bits 4pc. Nutsetters, 3pc. Brad point hex shank drill bits 4pc. Wood boring hex shank drill bits, 1pc. Bit dispenser 1pc. Magnetic bit holder, 1pc. Thumb driverr 1pc. Drill and Driverr IQD Body, 2pc. Replacement drills 1pc. Drill and Driverr countersink insert, 2pc. Set screws 1pc. 2-in-1 connector

26PC. SOCKETS AND BITS SET



Item no.	Contents
23 91 00 84	7pc. Socket bits:PH1-PH2-PH3, SL:4-5-6 Hex:4-5-6, Tx: T10-T15-T20-T25-T30, 9pc.1/4" Sockets:5-6-7-8-9-10-11-12-13 1pc. 1/4" extention bar,100mm, 1pc.1/4" universal joint,1pc.1/4" ratchet handle

20PC. DRIVER BITS AND SOCKETS SET



Item no.	Contents
23 91 00 87	12pc.25mm driver bits 5pc. 1/4" Sockets: 4.0-6.0-8.0x2-10.0 1pc.T ratchet handle 1pc. Magnetic bit holder

48PC. COMBINATION TOOLS



Item no.	Contents
23 91 00 91	

26PC. DRIVER BITS AND SOCKETS SET



S2 driver bits
Nickel plated
With colorful ring

Item no.	Contents
23 91 00 92	18pc. 25mm driver bits, SL: 3-4-5-6, PH: PH0X2-PH1X2-PH2X2-PH3X2 PZ: PZ0X2-PZ1X2-PZ2X2-PZ3X2, HEX: 3-4-5-6 Tx: T10-T15-T20-T25-30-T40 6pc. 1/4" sockets set: 5-6-7-8-9-10 1pc. 25mm socket adaptor 1pc. Magnetic bit holder, 1pc. Ratchet handle

41PC.DRIVER BITS SET



S2 driver bits
Nickel plated
With colorful ring

Item no.	Contents
23 91 00 85	40pc.S2 driver bits, 25mm, SL: 3-4-5-6 PH: PH0X2-PH1X2-PH2X2-PH3X2 PZ: PZ0X2-PH1X2-PH2X2-PH3X2 HEX:3.0-4.0-5.0-6.0, HEX with central hole: 3.0-4.0-5.0-6.0 Tx:T10-T15-T20-T25-T30-T40 Tx with central hole:T10-T15-T20-T25-T30-T40 1pc. Quick change connector

61PC. DRIVER BITS SETS NICKEL PLATED, WITH COLORFUL RING



Item no.	Contents
23 91 00 88	60pc. 25mm driver bits 1pc. Ratchet wrench

48PC. COMBINATION TOOLS



Item no.	Contents
23 91 00 89	

28PC.DRIVER BITS AND SOCKETS SET



S2 driver bits
Nickel plated
With colorful ring

Item no.	Contents
23 91 00 93	18pc. 25mm driver bits, SL: 3-4-5-6 PH: PH1-PH2-PH3, PZ: PZ1-PZ2-PZ3 HEX: 3-4-5-6, TX:T10-T15-T20-T25 8pc. 1/4" sockets: 5-6-7-8-9-10-11-12 1pc. 1/4" extention bar 1pc. Manual ratchet handle

34PC. DRIVER BITS SETS



Item no.	Contents
23 91 00 86	32pc. 25mm driver bits 1pcs. Socket adaptor 1pc. Quick change connector

26PC. COMBINATION TOOLS



Item no.	Contents
23 91 00 90	

54PC. QUICK CHANGE DRIVER BITS SET



Item no.	Contents
23 91 00 75	32pc. 25mm driver bits, 13pc. 50mm driver bits 3pc. 75mm driver bits, 4pc. Nutsetters 1pc. High-Torque magnetic bit holder 1pc. Quick change connector

54PC. POWER DRIVING SET



Item no.	Contents
23 91 00 76	33pc. 25mm driver bits 9pc. 50mm driver bits 3pc. 75mm driver bits 7pc. Nutsetters 1pc. Magnetic bit holder 1pc. Quick change connector

83PC. HEX SHANK DRILL AND DRIVER SET



Item no.	Contents
23 91 00 77	14pc. Titanium hex shank drill bits 33pc. 25mm driverr bits, 16pc. 50mm driverr bits 4pc. Nutsetters, 3pc. Brad point hex shank drill bits 4pc. Wood boring hex shank drill bits, 1pc. Bit dispenser 1pc. Magnetic bit holder, 1pc. Thumb driverr 1pc. Drill and Driverr IQD Body, 2pc. Replacement drills 1pc. Drill and Driverr countersink insert, 2pc. Set screws 1pc. 2-in-1 connector

47PC. POWER DRIVING SET



Item no.	Contents
23 91 00 78	32pc.25mm driver bits 10pc.50mm driver bits 3pc. Nutsetters 1pc.Adaptor 1pc.Magnetic bit holder

40PC. SCREWDRIVER BITS SET



Item no.	Contents
23 91 00 79	35pc. 25mm driver bits 4pc. 90mm driver bits 1pc. Magnetic bit holder

20PC. SCREWDRIVER BITS SET



Item no.	Contents
23 91 00 80	17pc. 50mm driver bits 3pc. Socket adaptor



31PC. SCREWDRIVER BITS SET



Item no.	Contents
23 91 00 81	21pc. 25mm driver bits 9pc. 60mm double head driver bits 1pc. Magnetic bit holder

18PC.90MM LONG DRIVER BITS SET



Item no.	Contents
23 91 00 82	PH: PH1-PH2X2-PH3 Tx:T10-T15-T20-T25-T27-T30-T40 PZ:PZ1-PZ2X2-PZ3, HEX:3-4-5

71PC.DRIVER BITS SET



Item no.	Contents
23 91 00 83	60pc.25mm driver bits, SL:3.0-4.0X2-5.0-6.0X2 PH: PH0X3-PH1X3-PH2X3-PH3X3 PZ:PZ0X3-PZ1X3-PZ2X3-PZ3X3 Tx:T10X3-T15X3-T20X3-T25X3-T27X3-T30X3-T40X3 HEX:3.0X2-4.0X2-5.0X2-6.0X3, 9pc. 90mm driver bits, PH: PH2-PH3, Tx:T10-T15-T20-T25-T27-T30-T40 1pc. Magnetic bit holder, 1pc. Quick change magnetic bit connector



26PC. SOCKETS AND BITS SET



Item no.	Contents
23 91 00 84	7pc. Socket bits:PH1-PH2-PH3, SL:4-5-6 Hex:4-5-6, Tx: T10-T15-T20-T25-T30, 9pc. 1/4" Sockets:5-6-7-8-9-10-11-12-13 1pc. 1/4" extention bar,100mm, 1pc.1/4" universal joint,1pc.1/4" ratchet handle

20PC. DRIVER BITS AND SOCKETS SET



Item no.	Contents
23 91 00 87	12pc.25mm driver bits 5pc. 1/4" Sockets: 4.0-6.0-8.0x2-10.0 1pc.T ratchet handle 1pc. Magnetic bit holder

48PC. COMBINATION TOOLS



Item no.	Contents
23 91 00 91	

26PC. DRIVER BITS AND SOCKETS SET



S2 driver bits
Nickel plated
With colorful ring

Item no.	Contents
23 91 00 92	18pc. 25mm driver bits, SL: 3-4-5-6, PH: PH0X2-PH1X2-PH2X2-PH3X2 PZ: PZ0X2-PZ1X2-PZ2X2-PZ3X2, HEX: 3-4-5-6 Tx: T10-T15-T20-T25-30-T40 6pc. 1/4" sockets set: 5-6-7-8-9-10 1pc. 25mm socket adaptor 1pc. Magnetic bit holder, 1pc. Ratchet handle

41PC.DRIVER BITS SET



S2 driver bits
Nickel plated
With colorful ring

Item no.	Contents
23 91 00 85	40pc.S2 driver bits, 25mm, SL: 3-4-5-6 PH: PH0X2-PH1X2-PH2X2-PH3X2 PZ: PZ0X2-PH1X2-PH2X2-PH3X2 HEX:3.0-4.0-5.0-6.0, HEX with central hole: 3.0-4.0-5.0-6.0 Tx:T10-T15-T20-T25-T30-T40 Tx with central hole:T10-T15-T20-T25-T30-T40 1pc. Quick change connector

61PC. DRIVER BITS SETS NICKEL PLATED, WITH COLORFUL RING



Item no.	Contents
23 91 00 88	60pc. 25mm driver bits 1pc. Ratchet wrench

48PC. COMBINATION TOOLS



Item no.	Contents
23 91 00 89	

28PC.DRIVER BITS AND SOCKETS SET



S2 driver bits
Nickel plated
With colorful ring

Item no.	Contents
23 91 00 93	18pc. 25mm driver bits, SL: 3-4-5-6 PH: PH1-PH2-PH3, PZ: PZ1-PZ2-PZ3 HEX: 3-4-5-6, TX:T10-T15-T20-T25 8pc. 1/4" sockets: 5-6-7-8-9-10-11-12 1pc. 1/4" extention bar 1pc. Manual ratchet handle

34PC. DRIVER BITS SETS



Item no.	Contents
23 91 00 86	32pc. 25mm driver bits 1pcs. Socket adaptor 1pc. Quick change connector

26PC. COMBINATION TOOLS



Item no.	Contents
23 91 00 90	

SCREWDRIVERS,
BITS AND HEXAGON KEYS

62PC. DRIVER BITS SET



S2 driver bits
Nickel plated
With colorful ring

Item no.	Contents
23 91 00 94	60pc. 25mm driver bits, SL: 3.0-4.0X2-5.0-6.0X2 PH: PH0X3-PH1X3-PH2X3-PH3X3 PZ: PZ0X3-PZ1X3-PZ2X3-PZ3X3 HEX: 3.0X2-4.0X2-5.0X2-6.0X3 Tx: T10X3-T15X3-T20X3-T25X3-T27X3-T30X3-T40X3 1pc. Magnetic bit holder, 1pc. Quick change connector

32PC. DRIVER BITS SET



S2 driver bits
Nickel plated
With colorful ring

Item no.	Contents
23 91 00 97	31pc. 25mm driver bits, SL: 3-4-5-6 PH: PH1-PH2X2-PH3, PZ: PZ1-PZ2X2-PZ3 HEX: 3-4-5-6, Tx: T10-T15-T20-T25-T27-T30-T40 Tx with central hole: T10-T15- T20-T25-T27-T30-T40 1pc. Quick change connector

24PC. DRIVER BITS AND SOCKETS SET



S2 driver bits
Nickel plated
With colorful ring

Item no.	Contents
23 91 01 01	16pc. 25mm driver bits, SL: 4-6 PH: PH1-PH2, PZ: PZ1-PZ2 HEX: 3-4-5-6, Tx: T10-T15-T20-T30-T40 6pc. 1/4" sockets: 6-7-8-10-11-13 1pc. Magnetic bit holder 1pc. Ratchet handle

29PC. DRIVER BITS AND SOCKETS SET



S2 driver bits
Nickel plated
With colorful ring

Item no.	Contents
23 91 00 95	18pc. 25mm driver bits, SL: 3-4-5-6 PH: PH0X2-PH1X2-PH2X2-PH3X2 PZ: PZ0X2-PZ1X2-PZ2X2-PZ3X2 Tx: T10-T15-T20-T25-T30-T40, HEX: 3-4-5-6 9pc. 1/4" sockets: 5-6-7-8-9-10-11-12-13 1pc. Quick change connector handle 1pc. Telescoping magnetic pick-up tool

30PC. DRIVER BITS SET



S2 driver bits
Nickel plated
With colorful ring

Item no.	Contents
23 91 00 98	28pc. 25mm driver bits, SL: 3-4-5-6-7 PH: PH0-PH1-PH2-PH3 PZ: PZ0-PZ1-PZ2-PZ3 HEX: 2-3-4-5-6, Tx: T10-T15-T20-T25-T30 SQ: S0-S1-S2-S3, 1pc. Magnetic bit holder 1pc. Ratchet handle

32PC. DRIVER BITS SET



S2 driver bits
Nickel plated
With colorful ring

Item no.	Contents
23 91 01 02	30pc. 25mm driver bits, SL: 3-4-5-6 PH: PH1-PH2X2-PH3, PZ: PZ1-PZ2X2-PZ3 HEX: 3-4-5-6 Tx: T10-T15-T20-T25-T27-T30-T40 Tx with central hole: T10-T15-T20-T25-T27-T30-T40 1pc. Magnetic bit holder 1pc. Ratchet handle

29PC. DRIVER BITS AND SOCKETS SET



S2 driver bits
Nickel plated
With colorful ring

Item no.	Contents
23 91 00 96	24pc. 25mm driver bits, SL: 3-4-5-5.5-6-7 PH: PH0-PH1-PH2-PH3, PZ: PZ0-PZ1-PZ2-PZ3 Tx: T10-T15-T20-T25-T30-T40, SQ: S0-S1-S2-S3 8pc. 1/4" sockets: 5-6-7-8-10-11-12-13 1pc. Socket adaptor, 1pc. Magnetic bit holder 1pc. Quick change connector

36PC. DRIVER BITS SET



S2 driver bits
Nickel plated
With colorful ring

Item no.	Contents
23 91 00 99	33pc. 25mm driver bits, SL: 3-4-5-6-8 PH: PH0-PH1-PH2X2-PH3 PZ: PZ0-PZ1-PZ2X2-PZ3, HEX: 3-4-5-6 Tx: T10X2-T15X2-T20X2-T25X2- T27X2-T30X2-T40X2, 1pc. bit adaptor 1pc. Magnetic bit holder, 1pc. Ratchet handle

41PC. DRIVER BITS SET



S2 driver bits
Nickel plated
With colorful ring

Item no.	Contents
23 91 01 03	40pc. 25mm Driver bits, SL: 3-4-5-6 PH: PH0X2-PH1X2-PH2X2-PH3X2 PZ: PZ0X2-PH1X2-PH2X2-PH3X2 HEX: 3.0-4.0-5.0-6.0 HEX with central hole: 3.0-4.0-5.0-6.0 Tx: T10-T15-T20-T25-T30-T40 Tx with central hole: T10-T15-T20-T25-T30-T40 1pc. Quick change connector



SCREWDRIVERS,
BITS AND HEXAGON KEYS

21PC. POWER DRILL AND DRIVER BITS SETS



Item no.	Contents
23 91 01 04	8pc. 50mm driver bits 5pc. 1/4" Nutsetters 7pc. Hex shank drill bits: 2.0-3.0-4.5-4.8-5.0-5.5-6.5 1pc. Magnetic bit holder

17PC. DRILLS AND DRIVER BITS SETS



Item no.	Contents
23 91 01 05	3pc. Flat wood drill bits 5pc. Wood drill bits 8pc. 25mm driver bits 1pc. Magnetic bit holder

24PC. HEX SHANK DRILL AND DRIVER BITS SETS



Item no.	Contents
23 91 01 06	8pc. 25mm driver bits 16pc. Titanium twist drill bits 1.5-2.0X2-2.5-3.0X2-3.2X2- 3.5-4.0-4.8-5.0-5.5-6.0X2

36PC. FASTENING DRIVER BITS SET



Item no.	Contents
23 91 01 07	24pc. 25mm driver bits 3pc. 1/4" Nutsetters 1pc. Magnetic bit holder

77PCS COMBINED TOOL KIT



Item no.	Contents
23 91 01 08	1pcs stubby adjustable wrench 1pcs ratchet handle 1pcs universal ratchet 9pcs Sockets (1/4"): 5-6-7-8-9-10-11-12-13mm 30pcs H4 Bits (L=30mm): SL: 1-1.5-2-2.5-3-3.5-4mm PH: PH000-PH00-PH0-PH1 PZ: PZ0-PZ1 Hex: 0.7-0.9-1.3-1.5-2-2.5-3-4mm Torx: T4-T5-T6-T7-T8-T9-T10-T15-T20 34pcs H6 Bits (L=25mm): SL: 3-4-5-6-6-7mm PH: PH0-PH1-PH1-PH2-PH2-PH3-PH3 PZ: PZ0-PZ1-PZ1-PZ2-PZ2-PZ3-PZ3 Hex: 2-2.5-3-4-5-5-6mm Torx: T10-T15-T20-T25-T27-T30-T40 1pcs adaptor

36PCS PRECISION BITS DRIVER SET



Item no.	Contents
23 91 01 09	1pcs precision screwdriver handle 1pcs extension bar with hose 1pcs 120mm Extension bar 1pcs magnifying glass 1pcs Tweezers 1pcs Mini pliers 30pcs 28mm Cr-V bits: SL: 1.0mm - 1.5mm - 2.0mm - 2.5mm - 3.0mm - 3.5mm - 4.0mm PH: PH0000 - PH00 - PH0 - PH1 PZ: PZ0 - PZ1 TORX: T4 - T5 - T6 - T7 - T8 - T9 - T10 - T15 - T20 HEX: 0.7mm - 0.9mm - 1.3mm - 1.5mm - 2.0mm - 2.5mm - 3.0mm - 4.0mm

47PCS COMBINATION TOOL SET



Item no.	Contents
23 91 01 10	6pcs precision screwdrivers: 2x50mm-2.5x50mm PH00x50mm-PH0x50mm T10x50mm-T15x50mm 1pcs bit driver 5pcs mini pliers 35pcs bits (L=25mm): SL: 2-2.5-3-4-5-6-7mm PH: PH0-PH1-PH1-PH2-PH2-PH3-PH3 PZ: PZ0-PZ1-PZ1-PZ2-PZ2-PZ3-PZ3 TORX: T10-T15-T20-T25-T27-T30-T40 HEX: 1.5-2-2.5-3-4-5-6mm

53PCS SCREWDRIVER BITS SET



Item no.	Contents
23 91 01 11	40pcs bits (L=25mm) 4pcs bits (L=50mm) 4pcs bits (L=75mm) 3pcs sockets 1pcs bit holder 1/4" 1pcs ratchet handle

28PCS COMBINED TOOL SET



Item no.	Contents
23 91 01 12	

101PCS S2 BITS SET



Item no.	Contents
23 91 01 25	95pcs bits (L=25mm): SL: 3-4-5-6mm, C1-C2-C3, M5-M6-M8 SL with hole: 4-6-8-10mm 3-wing: 1-2-3-4mm, 4-wing: 6-8-10mm, S0-S1-S2-S3 Metric HEX with hole: 2-2.5-3-4-4.5-5-5.5-6mm SAE HEX with hole: 5/64"-3/32"-7/64"-1/8"-9/64"-5/32" PZ0-PZ1-PZ1-PZ2-PZ2-PZ2-PZ3-PZ3 TORX with hole: T8-T10-T15-T20-T25-T27-T30-T40-T45 PH0-PH0-PH1-PH1-PH2-PH2-PH3-PH3 T8-T10-T10-T15-T15-T20-T20-T25-T25-T27-T30-T40-T45 Metric HEX: 1.5-2-2.5-3-4-4.5-5-5.5-6mm SAE HEX: 1/16"-5/64"-3/32"-7/64"-1/8"- 9/64"-5/32"-3/16"-7/32"-1/4" 3pcs adaptors, 1pcs magnetic bit holder 1pcs socket adaptor, 1pcs ratchet handle

21PCS BITS SET



Item no.	Contents
23 91 01 26	1pcs aluminum bit handle 20pcs bits (L=30mm): SL: 1.5-2-2.5-3-3.5-4mm PH000-PH00-PH0-PH1 PZ0-PZ1 T5-T6-T7-T8-T9-T10-T15-T20

COMBINED TOOL SET & BIT SET



Item no.	Contents
23 91 01 27	16pcs bits (L=25mm) 9pcs multi-lock precision sockets(L=25mm) 1pcs adaptor 1/4" 1pcs ratchet handle 1pcs socket adaptor 1/4"

COMBINED TOOL SET & BIT SET



23 91 01 13



23 91 01 14



23 91 01 15



DISPLAY BOX

Item no.	Contents
23 91 01 13	17PCS COMBINED TOOL SET
23 91 01 14	19PCS COMBINED TOOL SET
23 91 01 15	32PCS BITS SET

COMBINED TOOL SET & BIT SET



23 91 01 16



23 91 01 17



23 91 01 18



23 91 01 19



23 91 01 20



23 91 01 21



23 91 01 22



23 91 01 23



23 91 01 24

Item no.	Contents
23 91 01 16	100PCS BITS SET 97pcs 1/4"x25mm Cr-V bits set 1pc 1/4"x25mm Y-type adaptor 1pc 1/4"x25mm square to hex adaptor 1pc 1/4"x60mm magnetic adaptor 1pc double color plastic case
23 91 01 17	49PCS BITS SET
23 91 01 18	40PCS COMBINED TOOL SET
23 91 01 19	42PCS COMBINED TOOL SET
23 91 01 20	79PCS BITS SET 78pcs 1/4"x25mm Cr-V bits 1pcs stubby ratchet bit driver 1pcs double color plastic case
23 91 01 21	38PCS BITS & SOCKETS SET 26pcs 1/4"x25mm Cr-V bits 9pcs Cr-V sockets, satin chrome plated: Specification: 5-13mm 1pc 1/4"x75mm adaptor, Forged carbon steel, hardened with chrome plated 1pc stubby ratchet handle 1pc 1/4"x25mm adaptor 1pc double color plastic case
23 91 01 22	26PCS POWER SOCKETS AND BITS SET 5pcs magnetic power sockets: 6-8-10-11-13mm 19pcs bits (L=25mm); SL: 4-5-6-7mm PH0-PH1-PH2-PH3 PZ0-PZ1-PZ2-PZ3 T10-T15-T20-T25-T27-T30-T40 1pcs aluminum quick release bit holder 1pcs PH2 Explosion-protection (S2 material bit)
23 91 01 23	26PCS BITS SET 24pcs bits (L=25mm): SL: 3-4-5-6mm PH0-PH1-PH2-PH3 PZ0-PZ1-PZ2-PZ3 T10-T15-T20-T25-T30-T40 TORX with hole: T10-T15-T20-T25-T27-T30-T40 HEX: 2-2.5-3-4-5-6mm 1pcs ratchet handle 1pcs bit holder
23 91 01 24	61PCS BITS SET 1pcs aluminum quick release bit holder 60pcs bits (L=25mm): SL: 3-4-5-5.5-6-7-8mm SL with hole: 4-6-8-10mm PH0-PH1-PH2-PH2-PH3-PH3 PZ0-PZ1-PZ2-PZ2-PZ3-PZ3 T8-T10-T15-T20-T25-T27-T30-T35-T40 TORX with hole: T10-T15-T20-T25-T27-T30-T40 HEX: 1.5-2-2.5-3-3.5-4-4.5-5-5.5-6-6-7-8mm HEX with hole: 2-2.5-3-4-5-6mm



15PCS COLOR CODING BITS SET



Item no.	Contents
23 91 01 28	1pc aluminum quick release bit holder 14pcs S2 bits (L=25mm): SL: 5-6mm PH1-PH2-PH3 PZ1-PZ3-PZ3 T10-T15-T20-T25-T30-T40

15PCS COLOR CODING BITS SET



Item no.	Contents
23 91 01 29	1pc aluminum quick release bit holder 14pcs S2 bits (L=25mm): SL: 4-5-6mm PH1-PH2-PH3 PZ1-PZ3-PZ3 T10-T15-T20-T25-T27

14PCS COLOR CODING BITS SET



Item no.	Contents
23 91 01 30	1pc aluminum quick release bit holder 1pc screwdriver handle 12pcs S2 bits (L=25mm): SL: 3-4-6mm PH1-PH2-PH3 PZ1-PZ3-PZ3 T10-T15-T20

56PCS RATCHET BIT TOOL SET



Item no.	Contents
23 91 01 31	1-Ratchat screwdriver handle 1-Precision screwdriver handle 1-Extension bar 32pcs 28mm Cr-v Precision bits 21pcs 25mm Cr-v Bits

70PCS RATCHET BIT TOOL SET



Item no.	Contents
23 91 01 32	1-Ratchat screwdriver handle 1-Precision screwdriver handle 1-Extension bar 1-25mm Adaptor 6pcs Hexagonal socket 30pcs 28mm Cr-v Precision bits 30pcs 25mm Cr-v Bits

18PC SCREWDRIVER BITS SET



Item no.	Contents
23 91 01 33	10pc 25mm CrV bits : 2pc Slotted:4, 5mm 2pc Torx: T15, T20 2pc Hex: H4, H5 2pc Phillips: PH1, PH2 2pc Pozi: PZ1, PZ2 4pc 75mm CrV bits 2pc Phillips: PH1, PH2 2pc Square: S1, S2 3pc 48mm extra sockets: 1/4", 5/16", 3/8" 1pc 50mm Adaptor

37PC TOOL SET



Item no.	Contents
23 91 01 34	1pc Bi-color ratchet handle 24pc bit set 8pc bits with holder 1pc measure tape 1pc level 1pc double-head plier 1pc adaptor

18PC PRECISION BITS SET



Item no.	Contents
23 91 01 35	1pc Bi-color ratchet screwdriver handle 1pc Extension bar 16pc Cr-V bit 8pc Torx: T4,T5,T6,T7,T8,T9,T10,T15 4pc Hex: H2, H2.5, H3, H4 4pc PH:PH00,PH0,PH1,PH2

SCREWDRIVERS,
BITS AND HEXAGON KEYS

22PC AUTO REPAIRING TOOL SET



Item no.	Contents
23 91 01 36	1pc Bi-color handle wrench 9pc 1/4" sockets:4,5,6,7,8,9,10,11,12mm 12pc Cr-V bits: 2pc Slotted:4mm, 5mm 2pc Phillips:PH1 PH2 4pc Torx: T15,T20,T25,T30 4pc Hex: H3,H4,H5,H6

38PC SCREWDRIVER BITS SET



Item no.	Contents
23 91 01 37	1pc 1/4" Bi-color Ratchet handle 37pc precision Screwdriver CR-V bits 4pc Torx with hole: T10,T15,T20,T30 6pc Torx: T10,T15,T20,T25,T30,T40 7pc Hex: 2.0,2.5,3.0,4.0,5.0,5.5,6.0mm 7pc PH: PH0*2,PH1*2,PH2*2,PH3 7pc SL: 2.0,2.5,3.0,4.0,5.0,5.5,6.0mm 4pc Pozi: PZ0, PZ1, PZ1, PZ3 2pc Square: S1, S2

26PC SCREWDRIVER BITS SET



Item no.	Contents
23 91 01 38	10pc 1/4"25mm Cr-V bits 2pc SL:4, 5mm 2pc Torx: T15, T20 2pc Hex: H4, H5 2pc PH: PH1, PH2 2pc PZ: PZ1, PZ2 5pc 50mm CrV bits 2pc Square: S2, S3 1pc Torx: T30 1pc extra socket

38PC RATCHETING T-DRIVER SET



Item no.	Contents
23 91 01 39	1pc Bi-color T handle ratchet screwdriver bits adapter 1pc 25mm Adaptor 1pc Soft extension bar 28pcs 5/32 Screwdriver bits: 7pcs Hex:H0.9, H1.3, H1.5, H2.0, H2.5, H3.0,H4.0 7pcs Torx:T5, T6, T7, T8, T9, T10,T15, T20 5pcs PH:PH000, PH00, PH0, PH1, PH2 6pcs SL:SL1.5,SL2,SL2.5, SL3, SL3.5,SL4 1pc Triangle:3.0mm 1pc Triwing: 3.0mm 1pc Round:1.0mm 7pcs 1/4 Sockets:4,5,5.5,6,6.5,7,8mm Surface:nickel finish

45PC RATCHETING T-DRIVER SET



Item no.	Contents
23 91 01 40	1pc Bi-color T handle ratchet screwdriver bits adapter 1pc 25mm Adaptor 1pc Extension bar 24pcs 1/4 Screwdriver bits: 4pcs PH: PH0, PH1,PH2, PH3 4pcs PZ:pz0,pz1,pz2,pz3 6pcs Torx: T10,T15,T20,T25,T30,T40 2pcs Square:S1,S2 4pcs Hex:H3,H4,H5,H6 4pcs SL:SL3,SL4, SL5, SL6 18pcs 1/4 Sockets: 9pc Metric: 4,5,5.5,6,7,8,9,10,12mm 9pc SAE:5/32,3/16,7/32,1/4,9/32,5/16,11/32,3/8,-/2" Surface:bits:black finish Socket: chrome plated

37PC RATCHETING T-DRIVER SET



Item no.	Contents
23 91 01 41	1pc Bi-color T handle ratchet screwdriver bits adapter 1pc Bi-color screwdriver handle 1pc 25mm Adaptor 1pc extension bar 12pcs 5/32 Screwdriver bits: 4pcs PH: PH00,PH0,PH1,PH2 4pcs Torx:T8,T9,T10,T15 4pcs SL:SL2,SL2.5,SL3,SL4 12pcs 1/4 Screwdriver bits: 4pcs PH: PH0,PH1,PH2,PH3 4pcs Torx:T20,T25,T30,T35 4pcs SL:SL3,SL4,SL5,SL6 9pcs 1/4 Sockets:4,5,5.5,6,7,8,9,10,12mm Surface:bits:black finish Socket: chrome plated



SCREWDRIVERS,
BITS AND HEXAGON KEYS

33PC TOOL SET



Item no.	Contents
23 91 01 42	1pc Bi-color ratchet screwdriver handle
	1pc Folding Hex Key
	1pc Ratchet wrench
	1pc Multi-function folding plier
	1pc Extra Socket
	9pc Socket:4,5,6,7mm
	24pc bits:
	13pc SL:3.0*2,4.0*2,5.0*3,6.0*4,7.0*2mm
	11pc PH: PH0*2,PH1*3,PH2*4,PH3*2

38PC SOCKETS AND BITS SET



Item no.	Contents
23 91 01 43	1pc Bi-color ratchet screwdriver handle
	1pc Folding Hex Key
	1pc Ratchet wrench
	1pc Adaptor
	9pc Socket:4,4.5,5.5,6,7,8,9,10mm
	24pc bits:
	13pc SL:3.0*2,4.0*2,5.0*3,6.0*4,7.0*2mm
	11pc PH: PH0*2,PH1*3,PH2*4,PH3*2

29PC SOCKETS AND BITS SET



Item no.	Contents
23 91 01 44	1pc Bi-color T handle wrench
	1pc Bi-color ratchet screwdriver handle
	1pc Extension bar
	1pc Adaptor
	9pc Socket:4,5,6,7,8,9,10,11,12mm
	16pc bits:
	4pc SL:3.0,4.0,5.0,6.0
	4pc PH: PH0,PH1,PH2,PH3
	4pc Hex:3.0,4.0,5.0,6.0
	4pc Torx:T20,T25,T30,T40

25PC SOCKETS AND BITS SET



Item no.	Contents
23 91 01 45	1pc Bi-color handle wrench
	1pc Bi-color ratchet screwdriver handle
	1pc Adaptor
	10pc Socket: 4,5,6,7,8,9,10,11,12,13mm
	12pc Bits:
	6pc SL: 3,4,5,5,6,7mm
	6pc PH: PH0,PH1*2,PH2*2,PH3

36PC SOCKETS AND BITS SET



Item no.	Contents
23 91 01 46	1pc Bi-color T handle wrench
	1pc Adaptor
	1pc Extra socket
	9pc Socket:4,5,6,7,8,9,10,11,12mm
	24pc bits:
	4pc SL:3.0,4.0,5.0,6.0
	4pc PH: PH0,PH1,PH2,PH3
	4pc Hex:3.0,4.0,5.0,6.0
	8pc Torx:T8,T9,T10,T15,T20,T25,T30,T40
	4pc PZ:PZ0,PZ1,PZ2,PZ3

26PC SOCKETS AND BITS SET



Item no.	Contents
23 91 01 47	1pc Bi-color Ratching handle wrench
	1pc Bi-color ratchet screwdriver handle
	1pc Adaptor
	1pc Extra socket
	10pc Socket:4,5,6,7,8,9,10,11,12,13mm
	12pc bits:
	6pc SL: 3,4,5,5,6,7mm
	6pc PH: PH0,PH1*2,PH2*2,PH3

24PC SOCKETS AND BITS SET



Item no.	Contents
23 91 01 48	1pc Bi-color T handle wrench
	1pc Bi-color ratchet screwdriver handle
	1pc Adaptor
	1pc Extra socket
	9pc Socket:4,5,6,7,8,9,10,11,12mm
	12pc bits:
	6pc SL: 3,4,5,5,6,7mm
	6pc PH: PH0,PH1*2,PH2*2,PH3

19PC PRECISION BITS AND SCREWDRIVER SET



Item no.	Contents
23 91 01 50	10pc CR-V bits size:
	2pc SL: 4.0mm,5.0mm;
	2pc PH:PH1,PH2
	2pc PZ:PZ1,PZ2;
	2pc Hex key:4.0mm,5.0mm;
	2pc Torx: T15, T20;
	7pc Chrome Plated Sockets:
	5-6-7-8-9-10-12mm
	1pc extension bar;
	1pc Bi-color ratchet handle
	Surface: satin finish

16PC PRECISION BITS AND SCREWDRIVER SET



Item no.	Contents
23 91 01 51	14pc CR-V bits size:
	PH PH000,PH00, PH0, PH1;
	Torx: T5, T6, T7, 78, T9;
	SL: 1.5mm, 2.0mm, 2.5mm, 3.0mm 4mm ;
	-1pc 4mm extension bar;
	-1pc Bi-color precision screwdriver handle
	Surface: nickel finish

11PC PRECISION BITS AND SCREWDRIVER SET



Item no.	Contents
23 91 01 52	10pc CR-V bits size: 2pc SL: 4.0mm,5.0mm; 2pc PH: PH1,PH2 2pc PZ:PZ1,PZ2; 2pc Hex key:4.0mm,5.0mm; 2pc Torx: T15, T20; 1pc Bi-color precision screwdriver handle Surface: satin finish

13PC PRECISION SCREDRIVER AND BITS SET



Item no.	Contents
23 91 01 55	1pc anodized aluminum bit holder 6pc bits size: Torx T5-T6-T7; Hex key:0.5-1.0-2.5mm; Cr-V, nickel finished -6pc Torx screwdriver: T5-T6-T7-T8-T9-T10; CR-V blades, dual- color handle Surface: satin finish

26PC SCREWDRIVER SET WITH 5/16 RATCHETING WRENCH SET



Item no.	Contents
23 91 01 58	1pc dural-color Ratcheting Wrench 6pc Sockets:5.0,6.0,7.0,8.0,9.0,10.0mm 2 Bits:1pc PH:PH1 1pc SL:3.0mm; Surface:chrome finish

6PC PRECISION SCREWDRIVER SET



Item no.	Contents
23 91 01 53	2pc precision screwdrivers, blade length 45mm size: PH00, SL 2mm 2pc precision screwdrivers, blade length 75mm size: PH0, SL 3mm 2pc precision screwdrivers, blade length 100mm size: PH1, SL 4mm Surface: satin finish

13PC PRECISION SCREDRIVER AND BITS SET



Item no.	Contents
23 91 01 56	1pc anodized aluminum bit holder 6pc bits size: Torx T5-T6-T7; Hex key:0.5-1.0-2.5mm; Cr-V, nickel finished -6pc Torx screwdriver: T5-T6-T7-T8-T9-T10; CR-V blades, dual- color handle Surface: satin finish

32PC MAGNETIC DRIVER GUIDE KIT WITH SELF STANDING CASE



Item no.	Contents
23 91 01 59	1pc 25.4mm screwdriving bit tips 9pc PH bits: PH1, (7) PH2, PH3, 7pc SL bits: #6,(5) #8, #10 6pc Square bits: #1, (4) #2, #3, 4pc hex bits: (2) 5/32", 3/16", 1/4" 4pc Torx bits: #10, (2) #15, #20 1pc magnetic bit tip handler magnetic drive guide with self standing case CR-V bits with phosphating treatment

7PC PRECISION SCREDRIVER AND MAGNIFIER SET



Item no.	Contents
23 91 01 54	1pc magnifier -6pc precision scredriver Size: SL 2-3mm; PH PH0, PH1; Torx T9, T10; CR-V blades, dual- color handle Surface: satin finish

15PC ALUMINIUM SCREWDRIVER HOLDER AND BIT SET



Item no.	Contents
23 91 01 57	3pc anodized aluminum bit holders 12pc CR-V bits: SL: 1.5-2-2.5-3mm or (1/32",3/64",5/64",3/32";) PH: #000,#00,#0,#1; Hex: 1.5-2-2.5-3mm Surface: nickel finish

10PC PRECISION SCREDRIVER SET



Item no.	Contents
23 91 01 60	3pc SL: 5/64", 1/8", 5/32", 3pc PH: PH00, PH0, PH1, 4pc Torx: T7, T8, T9, T10; CR-V blades, dual- color handle Surface: satin finish

SCREWDRIVERS,
BITS AND HEXAGON KEYS



43PC RATCHETING T-DRIVER SET



Item no. Contents

23 91 01 61	<p>1pc Aluminium bit handle 42pcs bits: 7pcs Hex:H0.7,H0.9,H1.3, H1.5,H2.0,H2.5,H3.0 5pcs Torx with hole:T7-T8- T9-T10-T15 8pcs Torx without hole:T4-T5- T6-T7-T8-T9-T10-T15 5pcs PH:PH000,PH00,PH0,PH1 4pcs PZ: Pz000,Pz00,Pz0,Pz1 9pcs SL:SL1.0,SL1.2,SL1.5, SL1.8,SL2.0,SL2.5,SL3.0,SL3.5,SL4.0 1pc Triangle:3.0mm; 1pc Triwing:3.0mm; 1pc Round:1.0mm 1pc spanner Surface: Nickel finish</p>
-------------	--------------------------------------------------------------------------------------------------------------------------------------------------------------------------------------------------------------------------------------------------------------------------------------------------------------------------------------------------------------------------------------------------------------------------------------------------------------

20PC SOCKETS AND BITS SET



Item no. Contents

23 91 01 63	<p>2pc Precision screwdriver: SL2.0mm and PH00 4pcs sockets:7,8,9,10mm 1 pc adaptor 10pcs bits: 4pcs Torx:T10-T15-T20-T25; 2pcs PH:PH1,PH2 2pcs PZ:Pz1,Pz2; 2pcs SL:SL5,SL6 1pc pocket hobby knife 1pc plastic level ruler 1pc tape measure Surface: Nickel finish</p>
-------------	------------------------------------------------------------------------------------------------------------------------------------------------------------------------------------------------------------------------------------------------------------------------------------------------------------------------

21PC AUTO-USE REPAIR SET



Item no. Contents

23 91 01 66	<p>1pc T type screwdriver bits and socket handle 9pcs socket, size: 5, 6, 7, 8, 9, 10, 11, 12, 13mm (3/16", 1/4", 9/32", 5/16", 11/32", 3/8", 7/16", 1/2", 9/16") 10pcs screwdriver bits PH: PH PH1, PH2 Torx: T15 T20 SL: 4.0, 5.0mm (5/32", 3/16") PZ:PZ1, PZ2 Hex: 4.0, 5.0mm (5/32, 3/16")</p>
-------------	------------------------------------------------------------------------------------------------------------------------------------------------------------------------------------------------------------------------------------------------------------------------------------------------------------------------------------------------

20 PCS SOCKETS AND BITS SET



Item no. Contents

23 91 01 62	<p>5 pcs Sockets:6,7,8,10,13mm -7pcs Torx with port:TP10- TP15-TP20-TP25-TP27-TP30-TP40 -2pcs PH:PH1,PH2 -2pcs PZ:Pz1,Pz2, -2pcs SL: 4.0,5.0mm -1pc 25mm Adaptor -1pc Ratchet Spanner -Surface: Nickel finish</p>
-------------	---------------------------------------------------------------------------------------------------------------------------------------------------------------------------------------------------------------------------------------------------

27PCS SOCKETS AND BITS SET



Item no. Contents

23 91 01 64	<p>1pc Power pole 19pcs bits: 5pcs Hex:H2.5,H3.0,H4.0,H5.0,H6.0 7pcs Torx:T10-T15-T20-T25-T27-T30-T40 4pcs PH:PH0,PH1,PH2,PH3 3pcs SL:SL3.0,SL4.0,SL6.0 5pcs Sockets:5.5, 7, 8, 10, 12mm 1pc Mini Ratchet Head 1pc 1/4" Adaptor Surface: Nickel finish</p>
-------------	------------------------------------------------------------------------------------------------------------------------------------------------------------------------------------------------------------------------------------------------------------------------------------------------

6PCS. PRECISION SCREWDRIVER SET

- ▶ Made of carbon steel
- ▶ With chrome plated handle
- ▶ Balck finish blade



Item no. Contents

23 50 90 01	<p>PH:0,1 Slot:1.4,2.0,2.4,3.0</p>
-------------	----------------------------------------

6PC PRECISION SCREWDRIVER SET



Item no. Contents

23 91 01 65	<p>3pc SL 5/64", 1/8", 5/32", 3pc PH PH00, PH0, PH1 Made of chrome vanadium steel Surface: satin finish Bi-color screwdriver handle and case</p>
-------------	------------------------------------------------------------------------------------------------------------------------------------------------------------------

6PCS. PRECISION MINI SOCKET SET

- ▶ With chrome-plated handles
- ▶ With screwdriver assistance
- ▶ In plastic box with transparent lid



Item no. Contents

23 50 90 02	<p>3.0-3.5-4.0-4.5-5.0 mm</p>
-------------	-------------------------------

5PCS. PRECISION OPEN END WRENCH SET

- ▶ With chrome-plated handles
- ▶ In plastic box with transparent lid



Item no.	Contents
23 50 90 03	4.0-4.5-5.0-5.5-6.0 mm

6PCS. PRECISION SCREWDRIVER SET

- ▶ Made of carbon steel ,with chrome plated handle
- ▶ Balck finish blade



Item no.	Contents
23 50 90 04	Slot:0.8/1.4/2.0/2.4/2.9/3.8

11PCS. PRECISION SCREWDRIVER SET

- ▶ *Made of carbon steel
- ▶ *With chrome plated handle
- ▶ *Balck finish blade



Item no.	Contents
23 50 90 05	PH:PH00/PH0/PH1 Slot:0.9/1.2/1.4/1.8/2.4/3.0

5PCS. PRECISION SCREWDRIVER SET

- ▶ Made of carbon steel
- ▶ With chrome plated handle.
- ▶ Balck finish blade,with extra-strenth bar



Item no.	Contents
23 50 90 06	PH:PH0/PH1 HEX:1.5/2/2.5

6PCS PRECISION SCREWDRIVER SET

- ▶ Made of carbon steel
- ▶ With chrome plated handle.
- ▶ Balck finish blade



Item no.	Contents
23 50 90 07	Torx::T5/T6/T7/T8/T9/T10

21PCS PRECISION SCREWDRIVER SET

- ▶ Made of carbon steel ,with chrome plated handle.
- ▶ Balck finish blade



Item no.	Contents
23 50 90 08	Slot:0.9,1.2,1.8,2.4,3.0,3.5 PH:PH0,PH1 open end: 4.0,4.5,5.0,5.5,6.0 HEX KEY WRENCH:1.5,2.0,2.5 mini socket:3.0,3.5,4.0,4.5,5.0

6-PCS. PRECISION SCREWDRIVER SET

- ▶ Hardened Chrome Vanadium Steel
- ▶ 2 componets plastic handle
- ▶ Blister Card



Item no.	Contents
23 50 90 09	Flat:2-3-4x50mm, PH: #000-#00-#0x50mm,

7-PCS.PRECISION SCREWDRIVER SET

- ▶ In chrome vanadium steel,
- ▶ Combined-colour handles,
- ▶ Packed in plastic box



Item no.	Contents
23 50 90 10	T5-T6-T7-T8-T9-T10-T15

8-PCS.PRECISION SCREWDRIVER SET

- ▶ Combined-colour handles,
- ▶ With changeable double end blades,
- ▶ In chrome vanadium steel
- ▶ Packed in plastic box



Item no.	Contents
23 50 90 11	Flat 1.5/2.0/3.0/4.0mm PH no.000/no.00/no.0/no.1 T-profile T5/T6/T7/T8/T9/T10



6-PCS PRECISION SOCKET SET

- ▶ In carbon steel,
- ▶ Combined-colour handles,
- ▶ Packed in plastic box



Item no.	Contents
23 50 90 12	1pc screwdriver handle 5pcs socket bits: 4.0/4.5/5.0/5.5/6.0mm

15PCS PRECISION SCREWDRIVERS SET

- ▶ Made of cr-v steel blade,with satin chrom plated,black tips
- ▶ 2 Components handle in ergonomic design,with anti-slip surface



Item no.	Contents
23 50 90 16	TORX:T5X50,T6X50,T7X50,T8X50, T9X50,T10X50,T12X50,T15X50 SL:1.5X50,2X50,2.5X50,3X50 PH:PH00X50,PH0X50,PH1X50

SCREWDRIVER

- ▶ New design comfortable pp handle
- ▶ Forged cr-v steel balde,hardened with satin chrome plated
- ▶ Black finished magnetic tips



Item no.	Contents
23 30 20 01	(-) 6x38
23 30 20 02	3x75
23 30 20 03	5x75
23 30 20 04	6x100
23 30 20 05	6x125
23 30 20 06	6x150
23 30 20 07	8x150
23 30 20 08	8x200
23 30 20 09	(+) PH2x38
23 30 20 10	PH0x75
23 30 20 11	PH1x75
23 30 20 12	PH2x100
23 30 20 13	PH2x125
23 30 20 14	PH2x150
23 30 20 15	PH3x150
23 30 20 16	PH3x200

12 IN 1 PRECISION SCREWDRIVER SET

- ▶ Packed in transparent convenient storage box



Item no.	Contents
23 50 90 13	6pcs double end Cr-V blades, Chrome-plated: SL: 1.5, 2.0, 3.0, PH: 000, 00, 0 Torx: 5, 6, 7, 8, 9 10 1pc precision handle with swivel end

6PCS PRECISION SCREWDRIVERS SET

- ▶ Made of Cr-V steel ,hardened with chrome plated blade.
- ▶ Bi-color pp handle



Item no.	Contents
23 50 90 17	Slot: 2.0X50mm, 2.5X50mm,3.0X50mm PH:000x50,00x50,0x50

SCREWDRIVER

- ▶ Made of Cr-V steel,hardened and satin chrome plated balde
- ▶ With injection transparent plastic handle



Item no.	Contents
23 30 20 17	(-) 6.5x38
23 30 20 18	3x75
23 30 20 19	4x75
23 30 20 20	4x100
23 30 20 21	5.5x100
23 30 20 22	6.5x100
23 30 20 23	6.5x125
23 30 20 24	6.5x150
23 30 20 25	8x150
23 30 20 26	8x200
23 30 20 27	(+) PH2x38
23 30 20 28	0x75
23 30 20 29	1x80
23 30 20 30	2x100
23 30 20 31	3x150

7PCS PRECISION SCREWDRIVERS SET

- ▶ Made of cr-v steel blade,with satin chrom plated,black tips
- ▶ 2 Components handle in ergonomic design,with anti-slip surface



Item no.	Contents
23 50 90 15	SL:1.5X50,2X50,2.5X50,3X50MM PH:PH00X50,PH0X50,PH1X50MM

7PCS PRECISION SCREWDRIVERS SET

- ▶ Made of Cr-V steel ,hardened with chrome plated blade .bi-color pp handle



Item no.	Contents
23 50 90 18	T5X40,T6X40,T7X40,T8X40, T9X40,T10X40,T15X40

SCREWDRIVERS,
BITS AND HEXAGON KEYS

SCREWDRIVER

- ▶ Made of Cr-V steel, hardened and satin chrome plated balde .
- ▶ With transparent plastic handle



Item no.	Contents
23 30 20 32	(-) 6.5x38
23 30 20 33	3x75
23 30 20 34	4x75
23 30 20 35	4x100
23 30 20 36	5.5x100
23 30 20 37	6.5x100
23 30 20 38	6.5x125
23 30 20 39	6.5x150
23 30 20 40	8x150
23 30 20 41	8x200
23 30 20 42	(+) PH2x38
23 30 20 43	0x75
23 30 20 44	1x80
23 30 20 45	2x100
23 30 20 46	3x150
23 30 20 47	3x150

SCREWDRIVER

- ▶ *Made of Cr-V steel balde, hardened, satin chrome plated. Balck finish magnetic tips.
- ▶ *With PP/TPR bi-color handle



Item no.	Contents
23 30 20 64	(-) 6.5x38
23 30 20 65	3x75
23 30 20 66	5x75
23 30 20 67	6x100
23 30 20 68	6x125
23 30 20 69	6x150
23 30 20 70	8x150
23 30 20 71	8x200
23 30 20 72	(+) PH2x38
23 30 20 73	PH0x75
23 30 20 74	PH1x75
23 30 20 75	PH2x100
23 30 20 76	PH2x125
23 30 20 77	PH2x150
23 30 20 78	PH3x150
23 30 20 79	PH3x200

SCREWDRIVER

- ▶ Made of Cr-V steel balde, hardened, satin chrome plated. Balck finish magnetic tips.
- ▶ With PP/TPR bi-color handle



Item no.	Contents
23 30 21 01	(-) 6.5x38
23 30 21 02	3x75
23 30 21 03	5x75
23 30 21 04	6x100
23 30 21 05	6x125
23 30 21 06	6x150
23 30 21 07	8x150
23 30 21 08	8x200
23 30 21 09	(+) PH2x38
23 30 21 10	PH0x75
23 30 21 11	PH1x75
23 30 21 12	PH2x100
23 30 21 13	PH2x125
23 30 21 14	PH2x150
23 30 21 15	PH3x150
23 30 21 16	PH3x200

SCREWDRIVER

- ▶ Made of S2 steel, hardened and satin chrome plated balde .
- ▶ With PP/TPR bi-color handle



Item no.	Contents
23 30 20 48	(-) 6.5x38
23 30 20 49	3x75
23 30 20 50	5x75
23 30 20 51	6x100
23 30 20 52	6x125
23 30 20 53	6x150
23 30 20 54	8x150
23 30 20 55	8x200
23 30 20 56	(+) PH2x38
23 30 20 57	PH0x75
23 30 20 58	PH1x75
23 30 20 59	PH2x100
23 30 20 60	PH2x125
23 30 20 61	PH2x150
23 30 20 62	PH3x150
23 30 20 63	PH3x200

SCREWDRIVER

- ▶ Made of Cr-V steel balde, hardened, satin chrome plated. Balck finish magnetic tips.
- ▶ With PP/TPR bi-color handle



Item no.	Contents
23 30 20 80	(-) 6.5x38
23 30 20 81	3x75
23 30 20 82	5x75
23 30 20 83	6x100
23 30 20 84	6x125
23 30 20 85	6x150
23 30 20 86	8x150
23 30 20 87	8x200
23 30 20 88	(+) 6x38
23 30 20 89	3x75
23 30 20 90	5x75
23 30 20 91	6x100
23 30 20 92	6x125
23 30 20 93	6x150
23 30 20 94	8x150
23 30 20 95	8x200

PROFESSIONAL SCREWDRIVER

- ▶ Blades made of chrome vanadium steel with extra-hardened black magnetic tips
- ▶ Chrome plated
- ▶ Heavy plastic handle



Item no.	Contents
23 30 21 17	(-) 3.0x75mm
23 30 21 18	(-) 4.0x100mm
23 30 21 19	(-) 6.5x125mm
23 30 21 20	(-) 8.0x150mm
23 30 21 21	(+)0#x60 mm
23 30 21 22	(+)1#x80 mm
23 30 21 23	(+)2#x100 mm
23 30 21 24	(+)3#x150 mm



SCREWDRIVER

- ▶ Made of Cr-V steel balde, hardened with hex bolster, satin chrome plated. Balck finish magnetic tips.
- ▶ With PP/TPR bi-color handle



Item no.	Contents
23 30 21 25	(-) 6.5x38
23 30 21 26	3x75
23 30 21 27	5x75
23 30 21 28	6x100
23 30 21 29	6x125
23 30 21 30	6x150
23 30 21 31	8x150
23 30 21 32	8x200
23 30 21 33	(+) PH2x38
23 30 21 34	PH0x75
23 30 21 35	PH1x75
23 30 21 36	PH2x100
23 30 21 37	PH2x125
23 30 21 38	PH2x150
23 30 21 39	PH3x150
23 30 21 40	PH3x200

SCREWDRIVER

- ▶ Made of Cr-V steel balde, hardened, satin chrome plated. Balck finish magnetic tips.
- ▶ With PP/TPR 3-color handle



Item no.	Contents
23 30 21 57	(-) 6.5x38
23 30 21 58	3x75
23 30 21 59	5x75
23 30 21 60	6x100
23 30 21 61	6x125
23 30 21 62	6x150
23 30 21 63	8x150
23 30 21 64	8x200
23 30 21 65	(+) PH2x38
23 30 21 66	PH0x75
23 30 21 67	PH1x75
23 30 21 68	PH2x100
23 30 21 69	PH2x125
23 30 21 70	PH2x150
23 30 21 71	PH3x150
23 30 21 72	PH3x200

SCREWDRIVER



Item no.	Contents
23 30 21 89	(-) 6x38
23 30 21 90	3x75
23 30 21 91	5x75
23 30 21 92	6x100
23 30 21 93	6x125
23 30 21 94	6x150
23 30 21 95	8x150
23 30 21 96	8x200
23 30 21 97	(+) PH2x38
23 30 21 98	PH0x75
23 30 21 99	PH1x75
23 30 22 01	PH2x100
23 30 22 02	PH2x125
23 30 22 03	PH2x150
23 30 22 04	PH3x150
23 30 22 05	PH3x200

SCREWDRIVER

- ▶ Made of Cr-V steel balde, hardened, satin chrome plated. Balck finish magnetic tips.
- ▶ With PP/TPR bi-color handle



Item no.	Contents
23 30 21 41	(-) 6.5x38
23 30 21 42	3x75
23 30 21 43	5x75
23 30 21 44	6x100
23 30 21 45	6x125
23 30 21 46	6x150
23 30 21 47	8x150
23 30 21 48	8x200
23 30 21 49	(+) PH2x38
23 30 21 50	PH0x75
23 30 21 51	PH1x75
23 30 21 52	PH2x100
23 30 21 53	PH2x125
23 30 21 54	PH2x150
23 30 21 55	PH3x150
23 30 21 56	PH3x200

SCREWDRIVER



Item no.	Contents
23 30 21 73	(-) 6x38
23 30 21 74	3x75
23 30 21 75	5x75
23 30 21 76	6x100
23 30 21 77	6x125
23 30 21 78	6x150
23 30 21 79	8x150
23 30 21 80	8x200
23 30 21 81	(+) PH2x38
23 30 21 82	PH0x75
23 30 21 83	PH1x75
23 30 21 84	PH2x100
23 30 21 85	PH2x125
23 30 21 86	PH2x150
23 30 21 87	PH3x150
23 30 21 88	PH3x200

SCREWDRIVER



Item no.	Contents
23 30 22 06	(-) 6x38
23 30 22 07	3x75
23 30 22 08	5x75
23 30 22 09	6x100
23 30 22 10	6x125
23 30 22 11	6x150
23 30 22 12	8x150
23 30 22 13	8x200
23 30 22 14	(+) PH2x38
23 30 22 15	PH0x75
23 30 22 16	PH1x75
23 30 22 17	PH2x100
23 30 22 18	PH2x125
23 30 22 19	PH2x150
23 30 22 20	PH3x150
23 30 22 21	PH3x200

SCREWDRIVER



Item no.	Contents
23 30 22 22	(-) 6x38
23 30 22 23	3x75
23 30 22 24	5x75
23 30 22 25	6x100
23 30 22 26	6x125
23 30 22 27	6x150
23 30 22 28	8x150
23 30 22 29	8x200
23 30 22 30	(+) PH2x38
23 30 22 31	PH0x75
23 30 22 32	PH1x75
23 30 22 33	PH2x100
23 30 22 34	PH2x125
23 30 22 35	PH2x150
23 30 22 36	PH3x150
23 30 22 37	PH3x200

SCREWDRIVER



Item no.	Contents
23 30 22 38	(-) 6x38
23 30 22 39	3x75
23 30 22 40	5x75
23 30 22 41	6x100
23 30 22 42	6x125
23 30 22 43	6x150
23 30 22 44	8x150
23 30 22 45	8x200
23 30 22 46	(+) PH2x38
23 30 22 47	PH0x75
23 30 22 48	PH1x75
23 30 22 49	PH2x100
23 30 22 50	PH2x125
23 30 22 51	PH2x150
23 30 22 52	PH3x150
23 30 22 53	PH3x200

SCREWDRIVER



Item no.	Contents
23 30 22 54	(-) 6.5x38
23 30 22 55	3x75
23 30 22 56	5x75
23 30 22 57	6x100
23 30 22 58	6x125
23 30 22 59	6x150
23 30 22 60	8x150
23 30 22 61	8x200
23 30 22 62	(+) PH2x38
23 30 22 63	PH0x75
23 30 22 64	PH1x75
23 30 22 65	PH2x100
23 30 22 66	PH2x125
23 30 22 67	PH2x150
23 30 22 68	PH3x150
23 30 22 69	PH3x200

PROFESSIONAL GO-THROUGH SCREWDRIVERS

- ▶ 2 components comfortable anti-slip grips
- ▶ Special design handle match human engineering theory.
- ▶ Chrome-Vanadium steel, hardened, black finished, magnetic tips.



Item no.	Contents
23 45 20 01	3.0x75mm
23 45 20 02	4.0x100mm
23 45 20 03	5.5x100mm
23 45 20 04	6.5x150mm
23 45 20 05	8.5x200 mm
23 45 20 06	PH0x60 mm
23 45 20 07	PH1x60 mm
23 45 20 08	PH2x100 mm
23 45 20 09	PH3x150mm
23 45 20 10	PH0x60 mm
23 45 20 11	PH1x60 mm
23 45 20 12	PH2x100 mm
23 45 20 13	PH3x150mm



7 PCS GO-THROUGH SCREWDRIVER SET

- ▶ Heavy duty square section fully hardened blades, matte chrome plated with special transparent plastic handles
- ▶ On plastic tray in color box with windows



Item no.	Contents
23 93 00 01	4x flat screwdrivers: 6x38, 5x75, 6x100, 8x150mm 3x PH screwdrivers: 1#x75, 2#x100, 3#x150

12-PCS. GO-THROUGH SCREWDRIVER SET

- ▶ Chrome vanadium steel blades, sandblasted and satin chrome plated, hex ashank blades, with magnetic and black reinforced tips.
- ▶ Packed in blow mould case with window



Item no.	Contents
23 93 00 02	SL: 1pc. 8.0x8.0x200 mm, 1pc. 7.0x7.0x150 mm, 1pc. 6.6x6.0x100 mm, 1pc. 5.0x5.0x75 mm, 1pc. 3.0x3.0x75 mm, 6.0x6.0x38 mm PH: 1pc. #3X8.0X200 mm, 1pc. #2x7.0x150 mm, 1pc. #2x7.0x100 mm, 1pc. #1x6.0x75 mm, 1pc. #0x4.0x75 mm, 1pc. #2x7.0x38 mm

12PCS PROFESSIONAL GO-THROUGH SCREWDRIVERS SET

- ▶ Made of Cr-V steel, hex shank blades, satin chrome finished. hex nut with central hole
- ▶ Double components anti-slip TPR handle, ergonomically designed



Item no.	Contents
23 93 00 03	SL: 6X38mm, 3X75mm, 5.5x75mm, 6x100mm, 8x150mm, 8X200mm PH: PH2X38mm, PH0X75mm, PH1X75mm, PH2X100mm, PH3X200mm.



SCREWDRIVERS,
BITS AND HEXAGON KEYS

10PCS PROFESSIONAL GO-THROUGH SCREWDRIVERS SET

- ▶ Manufactured from expert Cr-V steel
- ▶ Double components anti-slip grip, ergonomically design for easy working.
- ▶ Hex shank blade, matte finish, magnetic tip, black finished.
- ▶ With end knob for striking work, The handle end with hardened flat bolster for easy striking.
- ▶ Packed in carrying blow case with window.



Item no.	Contents
23 93 00 04	SL: 6X38MM, 3X75MM, 5X100MM, 6X125MM, 8X150MM PH: PH2X38MM, PH0X75MM, PH1X100MM, PH2X100MM, PH3X150MM

12PCS PROFESSIONAL GO-THROUGH SCREWDRIVERS SET

- ▶ Made of Cr-V steel,hex shank blades,satin chrome finished. With end knob for striking work
- ▶ Double components anti-slip TPR handle,ergonomically designed



Item no.	Contents
23 93 00 05	SL: 10X200MM,8X150MM,6.5X100MM, 5.5X75MM,3X75MM,6.5X38MM PH: PH4X200MM,PH3X150MM PH2X100MM, PH1X75MM, PH0X75MM, PH2X38MM

7 IN 1 EXTENSIVE SCREWDRIVER

- ▶ Made of aluminum extensive blade
- ▶ Lacquered surface with magnetic tips
- ▶ TPR+PP bi-material handle



Item no.	Contents
23 93 00 06	7pcs brass coated 25mm bits: SL: 5,6,7 PH:PH1,PH2,PH3 Torx:T15,T20

7 IN 1 PROFESSIONAL SCREWDRIVER SET



Item no.	Contents
23 90 00 07	6pcs 1/4"x25mm bits: PH:PH1,PH2 Torx:T15,T20 SL:1/4",3/16" Made of cr-v steel,heat treated for tough working,sand blasting. Six bits are sotred in a Holder around the blade 3 Component anti-slip massage tpr grip 1pc bits holder and telescoping magnetic pick-up tool exchangeable Extend to 420mm to pick up screws,nuts etc

6 IN 1 SCREWDRIVER SET



Item no.	Contents
23 90 00 08	tpr+pp bi-color bits handle with magnetic bits holder 6PCS BITS: Torx:T15,T20 PH:PH1,PH2 SL:5,6

4 IN 1 SCREWDRIVER SET

- ▶ Bi-color bits handle,with magnetic bits holder.



Item no.	Contents
23 90 00 09	2pcs double end bits 1PC 1/4" PH2 1PC 3/16" PH1

6 IN 1 SCREWDRIVER SET



Item no.	Contents
23 90 00 10	3pcs double end bits: 1pc SL:3/16",1/4" 1pc PH:PH1,2 1pc HEX:1/4"and 5/16" 1pc screwdriver handle

4 IN 1 SCREWDRIVER SET



Item no.	Contents
23 93 00 11	2pcs double end bits 1pc 1/4" and PH2 1pc 3/16" and PH1 Bi-color bits handle With magnetic bits holder

51PCS DRIVER AND BIT SET



Item no.	Contents
23 93 00 12	1pc bits holder with 2 light 24pcs bits;SL: 4,5,6,7,1/8",3/16",1/4" PH:PH0,PH1,PH2,PH3, PZ:PZ1,PZ2 Torx:T10,T15,T20,T25,T30,T40 Hex:3/32", 1/8", 5/32",3/16", 1/4" 1pc 1/4"x25mm square and hex adaptor 1pc 1/4"x60MM magnetic adaptor 1pc 235mm soft shaft,with black finished 12pcs sockets;4/ 4.5/ 5/ 5.5/ 6/ 7/ 8/ 9/ 10/ 11/ 12/ 13

IMPACT SCREWDRIVER



Item no.	Contents
23 99 00 01	4pcs 5/16"x35mm bits; PH:PH2,PH3 SL:8,10

AUTOMATIC SCREWDRIVER

- ▶ Made of aluminum screw mandrel blade, with tpr+pp bi-color handle.



Item no.	Contents
23 99 00 02	350/500mm

HOOK SET

- ▶ Mini-hook
- ▶ Made of carbon steel blade, chrome plated, with PP handle



Item no.	Contents
23 90 00 01	4" square head hook
	4" taper head hook
	3" double end (PH and SL head) hook
	1.5" double end (PH and SL head) hook

2PCS EXTRAL LONG SCREWDRIVER SET

- ▶ Made of high quality cr-v steel,
- ▶ Hardened and tempered, black finish surface, with ergonomic tpr massage handle



Item no.	Contents
23 93 00 13	PH2x450mm, hex shank
	SL 6x450mm quare shank

3 PCS SPECIAL SCREWDRIVER SET

- ▶ Made of carbon steel blade, hardened with plastic coated.
- ▶ Smooth plastic handle



Item no.	Contents
23 90 00 02	SL:4X100mm
	PH:1X100mm
	PZ:1X100mm

3 PCS SPECIAL SCREWDRIVER SET

- ▶ Expert tools.
- ▶ Made of cr-v steel, satin chrome plated blade
- ▶ Tpr+pp bi-color soft handle with ergonomic design



Item no.	Contents
23 90 00 03	75mm

9PCS SCRAPER AND PICK HOOK KIT

- ▶ Made of cr-v steel, hardened with black finished
- ▶ Gasket scraping, pin/clip pick hook 90 and bent type hose removal
- ▶ Tpr+pp bi-color soft handle with ergonomic design



Item no.	Contents
23 90 00 04	4pcs 150mm length
	4pcs 75mm length

26PCS SOCKET AND BIT SET



Item no.	Contents
23 90 00 05	1pc ratchet handle
	16pcs 1/4"x25mm bits;
	SL: 3/4/5/6
	PH:PH0/1/2/3
	PZ:PZ0/1/2/3
	Torx:T15/20/25/30
	1pc 1/4"X60MM magnetic adaptor
	7pcs sockets;6/ 7/ 8/ 9/ 10/ 11/ 12

26PCS SOCKET AND BIT SET



Item no.	Contents
23 90 00 06	1pc ratchet handle
	16pcs 1/4"x25mm bits;
	SL: 3/4/5/6
	PH:PH0/1/2/3
	PZ:PZ0/1/2/3
	Torx:T15/20/25/30
	1pc 1/4"X60MM magnetic adaptor
	7pcs sockets;6/ 7/ 8/ 9/ 10/ 11/ 12

26PCS SOCKET AND BIT SET



Item no.	Contents
23 90 00 07	1pc flexible ratchet handle
	16pcs 1/4"x25mm bits;
	SL: 3/4/5/6
	ph:PH0/1/2/3
	PZ:PZ0/1/2/3
	Torx:T15/20/25/30
	1pc 1/4"X60MM magnetic adaptor
	7pcs sockets;6/ 7/ 8/ 9/ 10/ 11/ 12





26PCS SOCKET AND BIT SET



Item no.	Contents
23 93 00 08	1pc flexible ratchet handle 16pcs 1/4"x25mm bits; SL: 3/4/5/6 ph:PH0/1/2/3 PZ:PZ0/1/2/3 Torx:T15/20/25/30 1pc 1/4"X60MM magnetic adaptor 7pcs sockets;6/ 7/ 8/ 9/ 10/ 11/ 12

53PCS SCREWDRIVER SET



Item no.	Contents
23 90 00 10	40pcs 1/4"X25mm cr-v bits SL: 3-3.5-4-4.5-5-5.5-6-6.5-7 PH:PH0-1-2-3 PZ:o,1,2,3 Hex:H2.5-3-4-5-5.5-6 Torx:T8-9-10-15-20-25-27-30-40 4pcs 1/4"X50mm Cr-V bits: PH1-PH3;PZ1-PZ3 1pc 60mm magnetic adaptor 3pcs powerful sockets:4,5,6 1pc ratchet handle

22PCS SOCKET AND BIT SET



Item no.	Contents
23 90 00 13	1pc t-ratchet handle 16pcs 1/4"x25mm bits; SL: 3/4/5/6 PH:PH0/1/2/3 PZ:PZ0/1/2/3 Torx:T15/20/25/30 5pcs sockets;8/ 9/ 10/ 11/ 12

26PCS SOCKET AND BIT SET



Item no.	Contents
23 90 00 09	1pc ratchet handle 1pc 1/4"X25mm hex and square adaptor 15pcs 1/4"X25MM Cr-V bits 9pcs 1/4"X25MM Cr-V sockets

8PCS RATCHET SCREWDRIVER SET



Item no.	Contents
23 90 00 11	1pc ratchet screwdriver 1pc bit driver 6pcs bits

23PCS SOCKET AND BIT SET



Item no.	Contents
23 90 00 14	1pc flexible ratchet handle 16pcs 1/4"x25mm bits; SL: 3/4/5/6 PH:PH0/1/2/3 PZ:PZ0/1/2/3 Torx:T15/20/25/30 1pc 1/4"X60MM magnetic adaptor 7pcs sockets;6/ 7/ 8/ 9/ 10/ 11/ 12

POWERFUL RATCHET HANDLE

- ▶ New design gun shape
- ▶ Made of PP/TPR bi-color handle,WITH MAGNETIC BITS HOLDER



Item no.	Contents
23 90 00 15	

6 IN 1 RATCHET SCREWDRIVER SET



Item no.	Contents
23 90 00 12	1pc ratchet screwdrivers 6pcs bits



SCREWDRIVERS,
BITS AND HEXAGON KEYS

8 IN 1 RATCHET DRIVER

- ▶ Made of clear plastic handle ,with 8pcs bits in it



Item no.	Contents
23 90 00 16	

6PCS SCREWDRIVER SET

- ▶ Made of carbon steel ,hardened and chrome plated surface with wooden handle



Item no.	Contents
23 93 00 14	SL:5X75,5X100,6X125,6X150 PH:PH1X75,PH2X100

7 PCS SCREWDRIVER SET

- ▶ DIN 5265/ISO 8764, made of chrome vanadium steel, extra hardened blades black magnetic tips.
- ▶ On plastic tray in color box with windows



Item no.	Contents
23 93 00 15	3 SL: 0.5x3x75, 0.8x4x100, 1.2x6.5x150mm 3 x PH :0#x60, 1#x80, 2#x100 mm 1 x PZ screwdriver 2#x6x125mm

8 PCS SCREWDRIVER SET

- ▶ Made of chrome vanadium steel, extra hardened blades, magnetic tips. Double color handles with holes
- ▶ On plastic tray in color box with windows.



Item no.	Contents
23 93 00 16	4 x SL: 0.6x3.5x75, 0.8x4x100, 1.0x5.5x125, 1.2x8.0x150mm 4 x PH 0#x75, 1#x100, 2#x100mm, 3#x150mm

7 PCS SCREWDRIVER SET

- ▶ Made of cr-v steel,hardened,satin chrome plated ,with magnetic tips,PP+TPR bi-color handle



Item no.	Contents
23 93 00 17	SL:4X75,5.5X100,6.5X125,8X150MM PH:PH0X60,PH1X75,PH2X100

6 PCS SCREWDRIVER SET

- ▶ Extra hardened blades.
- ▶ In Blister card with holder



Item no.	Contents
23 93 00 18	SL:3", 4", 5", 6". PH: 3", 4"

6 PCS SCREWDRIVER SET

- ▶ Made of cr-v steel,hardened,satin chrome plated ,with magnetic tips,PP+TPR bi-color handle



Item no.	Contents
23 93 00 19	SL: 1/4"X5",3/16"x4",1/8"X3" PH: PH2X5",PH1X4",PH0X3"

7PCS PROFESSIONAL SOCKET SCREWDRIVER SET

- ▶ Made of Chrome-Vanadium steel, #50BV-30 steel for making socket screwdriver
- ▶ Blade is Polished and chrome plated
- ▶ Hexagon bolster close to the handle for extra torque when using a spanner
- ▶ Comfortable double-color TPR handle with hanging hole
- ▶ Magnetic sockets
- ▶ In professional plastic holder



Item no.	Contents
23 93 00 20	3/16", 1/4", 5/16", 11/32", 3/8", 7/16", 1/2"

10PCS SCREWDRIVER SET

- ▶ Chrome plated hardened blades with rubber/plastic handles. with adjustable holder.
- ▶ In double blister card



Item no.	Contents
23 93 00 21	4x SL: 1.5", 3", 4", 6", 6" 4x PH: 1.5", 3", 4", 6", 6" 2xstubby: 6x38mm,PH2x38mm

16 PCS SCREWDRIVER SET

- ▶ Made of cr-v steel blade,hardened and satin chrome plated surafce,with TPR+PP handle



Item no.	Contents
23 93 00 25	SL: 5/16"X6",1/4"X4",3/16"X3" PH2X4",Ph1X3" 1pc ratchet screwdriver handle 10pcs 25mm bits



100PCS COMBINED TOOL SET

► Packed in plastic tray + double blister



Item no.	Contents
23 93 00 22	13pcs 50mm Cr-V bit Hex: 2, 2.5, 3, 4, 5, 6mm Torx: 10, 15, 20, 25, 27, 30, 40
	13pcs 75mm Cr-V bits: SL with central hole: 4(x5) PH: 2(x3) Torx: T20(x5)
	25mm Cr-V bits SL: 3, 4, 4.5, 5, 5.5, 6, 6.5, 7, 8mm, 3/32", 7/64", 1/8", 9/64", 5/32", 3/16", 7/32", 1/4", 9/32" Hex: 1.5, 2, 2.5, 3, 4, 5, 5.5, 6, 8mm, 1/16", 5/16", 3/32", 7/64", 1/8", 9/64", 5/32", 3/16", 7/32", 1/4", PH: 0, 1(x2), 2(x10), 3(x2) PZ: 0, 1(x2), 2(x10), 3(x2) C: 1, 2, 3 M: 5, 6, 8 Square: 0, 1, 2, 3 3-wing: 1, 2, 3, 4 4-wing: 6, 8, 10 SL-with central hole: 4, 6, 8, 10 Torx: 7, 8, 9, 10, 15, 20, 25, 27, 30, 35, 40, 45 Torx with central hole: 7, 8, 9, 10, 15, 20, 25, 27, 30, 35, 40 Hex with central hole: 2, 2.5, 3, 4, 5, 6 5/64", 3/32", 7/64", 1/8", 9/64", 5/32"
	1pc 25 mm bit adaptor 1pc 1/4" Dr socket adaptor 1pc 60mm magnetic bit holder 1pc 50mm bit adaptor 1pc 1/4" dr ratchet spanner 1pc stubby bit driver with 2 components handle

6 PCS SCREWDRIVER SET

► Made of cr-v steel blade, hardened and satin chrome plated surface, with TPR+PP handle



Item no.	Contents
23 93 00 24	Slot: 3X75, 4X75, 5.5X100. PH0X75, PH1X75, PH2X100

18 PCS SCREWDRIVER SET

► Made of cr-v steel blade, hardened and satin chrome plated surface, with TPR+PP handle



Item no.	Contents
23 93 00 26	10pcs precision screwdrivers SL: 2.0, 2.5, 3.0X50mm PH: PH0, PH00X50mm 8pcs screwdrivers: sizes: Slot: 6x38, 5x75, 6x100, 8X150 PH: PH1X75, PH2X38, PH2X100, PH3X150

36 PCS SCREWDRIVER SET



Item no.	Contents
23 93 00 27	11pcs screwdrivers, made of Cr-V steel blade, hardened and satin chrome plated surface, with TPR+PP handle sizes: PH3X200, PH2X100 SL: 6X150, SL5X150 Square: 2X150, 1X150, 0X75 T25X100, T15X100, T10X100 1pc bit holder 4pcs precision screwdrivers, sizes: PH00, PH000X50mm; Slot: 2.5, 2X50mm 20pcs bits. SL: 3, 4, 5, 6. PZ: #0, 1, 2, 3 PH0, 1, 2, 3. Torx: 10, 15, 20, 25 HEX: 3, 4, 5, 6

53 PCS SCREWDRIVER SET



Item no.	Contents
23 93 00 28	24pcs bits. Sizes: Slot: 3, 4, 5, 6, 7, 8. PH: 0, 1, 2, 3. PZ: 0, 1, 2, 3, Square: 0, 1, 2, 3 Hex: 2, 2.5, 3, 4, 5, 6 4pcs precision screwdrivers, sizes: T6, 7, 8, 9X50mm 11pcs screwdrivers, sizes: SL: 4x75, 5.5x100, 6x38, 8x150, 3X75 PH: PH0X75, PH1X75, PH2X100, PH3X150, PH1X100, PH2X38 7pc bit holder: Square: S0X75, S1X100, S2X150 Torx: T10, T15, T20, T25X100

60 PCS SCREWDRIVER SET



Item no.	Contents
23 93 00 29	34pcs bits: sizes: SL: 3, 4, 5, 6, 7, 8; PH: 0, 1, 2, 3; PZ: 0, 1, 2, 3; Torx: T10, T15, T20, T25, T30, T40 HEX (Metric): 2, 3, 4, 5, 6mm HEX (SAE): 3/32", 1/8", 5/32", 3/16", 1/4" 34pcs bits: sizes: SL: 3, 4, 5, 6, 7, 8; PH: 0, 1, 2, 3; PZ: 0, 1, 2, 3; Torx: T10, T15, T20, T25, T30, T40 HEX (Metric): 2, 3, 4, 5, 6mm HEX (SAE): 3/32", 1/8", 5/32", 3/16", 1/4" 4pcs precision screwdrivers, sizes: PH0, 00X50mm SL 2.5, 3X50mm 8pcs Screwdrivers: SL6X150, SL4X75, SL6X38, SL5.5X100; PH2X38, PH3X150, PH2X100, PH1X75 7pcs bits holder Square: S0X75, S1X100, S2X150 Torx: T10, T15, T20, T25X100

40 PCS SCREWDRIVER SET



Item no.	Contents
23 93 00 23	13pcs screwdriver, forged cr-v steel blade: SL: 5X75, 5X150, 6X100, 8X150 PH1X75, PH1X150, PH2X100, PH3X150 T15X100, T20X100, T25X100, T30X100 6pcs precision screwdrivers, forged cr-v steel blade PH000X75, PH1X75 SL2.5X75, 3X75 T9x75, T10X75 1pc long ratchet handle 20pcs 1/4"X2mm cr-v bits

SCREWDRIVERS,
BITS AND HEXAGON KEYS

22 PCS SCREWDRIVER SET



Item no. Contents

23 93 00 30	9pcs 1/4" sockets: sizes:5,6,7,8,9,10,11,12,13mm 4pcs precision screwdrivers, sizes:PH0,00X50mm SL2.5,3X50mm 6pcs screwdrivers; SL8X150,SL6X100,SL5x75 PH3X150,PH2X100,PH1X75 1pc H type ratchet handle
--------------------	---------------------------------------------------------------------------------------------------------------------------------------------------------------------------------------------------------------------------------

27 PCS SCREWDRIVER SET



Item no. Contents

23 93 00 32	10pcs Screwdrivers:SL6X150,SL4X75,SL6X38,SL5.5X100,SL3X75, PH2X38, PH3X150,PH2X100,PH1X75,PH0X75 4pcs precision screwdrivers, sizes:PH0,00X50mm SL2.5,3X50mm 10pcs bits; sizes:Slot:3,4,5,6; PH:1,2,3; PZ:1,2,3; 1pc screwdriver magnetizer 1pc bits holder
--------------------	----------------------------------------------------------------------------------------------------------------------------------------------------------------------------------------------------------------------------------------------------------------------------------

49 PCS SCREWDRIVER SET



Item no. Contents

23 93 00 35	34pcs bits: sizes:SL:3,4,5,6,7,8; PH:0,1,2,3; PZ:0,1,2,3; Torx:T10,T15,T20,T25,T30,T40 HEX(Metric):2,3,4,5,6mm HEX(SAE):3/32",1/8",5/32",3/16",1/4" Square:0,1,2,3 4pcs precision screwdrivers, sizes:PH0,00X50mm SL2.5,3X50mm 1pc bits holder 6pcs screwdrivers sizes:SL5X75,SL6X150, PH2X100,PH1X50
--------------------	-------------------------------------------------------------------------------------------------------------------------------------------------------------------------------------------------------------------------------------------------------------------------------------------------------------------------------------------

53 PCS SCREWDRIVER SET



Item no. Contents

23 93 00 31	34pcs bits; sizes:Slot:3,4,5,6,7,8; PH:0,1,2,3; PZ:0,1,2,3; Square:0,1,2,3Torx:T10, T15,T20,T25,T30,T40 HEX(Metric):2,3,4,5,6mm HEX(SAE):3/32",1/8",5/32",3/16",1/4" 4pcs precision screwdrivers, sizes:PH0,00X50mm SL2.5,3X50mm 6pcs screwdrivers; SL8X150,SL6X100,SL5x75 PH3X150,PH2X100,PH1X75 1pc bit holder 2pcs S-type double end bits
--------------------	-------------------------------------------------------------------------------------------------------------------------------------------------------------------------------------------------------------------------------------------------------------------------------------------------------------------------------------------------------------------------------------

9 PCS SCREWDRIVER SET

► Made of cr-v steel blade,hardened and satin chrome plated surafce,with TPR+PP handle



Item no. Contents

23 93 00 33	SL:8X150,6X100,5x75,3X75,6X38. PH:PH2X38,PH2X100,PH1X75,PH0X75
--------------------	-------------------------------------------------------------------

58 PCS SCREWDRIVER SET



Item no. Contents

23 93 00 34	30pcs bits. Sizes:Slot:3,4,5,6,7,8.PH:0,1,2,3. PZ:0,1,2,3, Square:0,1,2,3 Hex:2,2.5,3,4,5,6. Torx:T10,T15,T20,T25,T30,T40 1pc stubby ratchet handle 9pcs 1/4" sockets sizes:5,6,7,8,9,10,11,12,13 1pc 200mm soft shaft 6pcs screwdrivers sizes:SL8X150,SL6X100,SL5x75 PH3X150,PH2X100,PH1X75
--------------------	-------------------------------------------------------------------------------------------------------------------------------------------------------------------------------------------------------------------------------------------------------------------------------------------------------------------------------

48PCS SCREWDRIVER SET



Item no. Contents

23 93 00 36	24pcs 1/4"X25mm bits: sizes:SL:3,4,5,6,7,8; PH:0,1,2,3; PZ:0,1,2,3; Torx:T10,T15,T20,T25,T30,T40 HEX(Metric):2,3,4,5,6,8mm Square:0,1,2,3 1pc hex and Square adaptor 10pcs 1/4"X50mm bits sizes:SL:4,5,6; PH:0,1,2,3; PZ:1,2,3; 1pc ratchet handle 6pcs metix sockets 6pcs SAE sockets
--------------------	----------------------------------------------------------------------------------------------------------------------------------------------------------------------------------------------------------------------------------------------------------------------------------------------------------------------



25 PCS SCREWDRIVER SET



Item no.	Contents
23 93 00 37	1pc ratchet handle 1pc hex and Square adaptor 1pc 60mm magnetic adaptor 10pcs 1/4"X25mm bits: Sizes:SL:4,5,6,7; PH:1,2,3; PZ:1,2,3; 6pcs sockets: sizes:8,9,10,11,12,13 6pcs precision screwdrivers sizes:SL: 2,2.5,3 PH0,PH00,PH000

26PCS SCREWDRIVER SET



Item no.	Contents
23 93 00 39	20pcs 1/4"X25mm m bits sizes:SL:3,4,5,6,7; PH:1,2,3; PZ:1,2,3; Torx:T10,T15,T20,T25; Hex:2,3,4,5,6 5pcs screwdrivers sizes:SL:6X150,5x75 PH:PH3X150,PH2X100,PH1X75 1pc bit holder

25PCS SCREWDRIVER SET



Item no.	Contents
23 93 00 41	10pcs 25mm cr-v bits, 12pcs 25x5mm cr-v bits, 1pc exchangeable adaptor, With magnetic tips 1pc mini quick screwdriver Holder 1pc 6x100mm adaptor

43 PCS SCREWDRIVER SET



Item no.	Contents
23 93 00 38	20pcs bits. Sizes:SL:4,5,6,7 PH:1,2,3.PZ:1,2,3, Hex:3,4,5,6.Torx:T10,T15,T20,T25,T30,T40 1pc stubby ratchet handle 1pc 25mm hex and square adaptor 1pc 60mm hex and square magnetic adaptor 8pcs sockets:5,6,7,8,9,10,11,12 8pcs L-type wrench 4pcs precision screwdrivers sizes:PH0,00X50mm SL2.5,3X50mm

71PCS BIT SET



Item no.	Contents
23 93 00 40	13pcs 1/4"X50mm bits SL:5,6mm PH:1,2,3 PZ:1,2,3 Torx:T10,15,20,25 1pc 60mm magnetic adaptor 34pcs 1/4"X25mm bits: sizes:SL(metic):4,5,6,7,8; SL(SAE):1/8",3/10",1/4" Square:0,1,2,3 PH:0,1,2,3; PZ:0,1,2,3; Torx:T10,T15,T20,T25,T30,T40 HEX(Metric):2,3,4,5,6,8mm HEX(SAE):3/32",1/8",5/32",3/16",1/4" 4pcs Y bits:1,2,3,4 2pcs X bits:8,10 13pc 1/4" sockets:4,4.5,5,5.5,6, 7,8,9,10,11,12,13,14 1pc short extension bar 1pc 25mm hex and square adaptor 1pc stubby adjustable wrench 1pc stubby H-handle 1pc stubby ratchet handle

10PCS SCREWDRIVER SET

► Made of cr-v steel blade,hardened and satin chrome plated surface,with TPR+PP handle



Item no.	Contents
23 93 00 42	Slot:8X200,6X150,5X100.3X75,6X38 PH:PH3X200,PH2X150,PH1X100, PH0X75,PH2X38

10PCS SCREWDRIVER SET

- Made of cr-v steel blade,hardened and satin chrome plated surafce,with TPR+PP handle



Item no. Contents

23 93 00 43	Slot:8X200,6X150,5X100.3X75,6X38 PH:PH3X200,PH2X150,PH1X100 PH0X75,PH2X38 1pc 50mm Cr-V bit adaptor 1pc 75mm bit holder 10pcs sockets: 4, 5, 6, 7, 8, 9, 10, 11, 12, 13mm 46pcs 25mm Cr-V bits: SL: 3, 4, 4.5, 5, 5.5, 6, 6.5, 7, 8mm PH: 0, 1, 2, 3 PZ:0, 1, 2, 3 Torx: 10, 15, 20, 25, 27, 30, 35, 40, 45 Hex: 1.5, 2, 2.5, 3, 4, 5, 5.5, 6, 8mm 3-Wing: 0, 1, 2, 3 4-Wing: 1, 2, 3 Square:0, 1, 2, 3
--------------------	---------------------------------------------------------------------------------------------------------------------------------------------------------------------------------------------------------------------------------------------------------------------------------------------------------------------------------------------------------------------------------------------------------------------------------------------------

8PCS SCREWDRIVER SET

- Made of S2steel blade,hardened and satin chrome plated surafce,with TPR+PP handle



Item no. Contents

23 93 00 44	Slot:6.5X38,5.5X75,6.5X100,8X150MM PH:PH2X38,PH0X75,PH1X75,PH2X100
--------------------	-----------------------------------------------------------------------

11PCS SCREWDRIVER SET



Item no. Contents

23 93 00 45	9PCS screwdrivers: SLOT:8x200,6x150,5x100,6x38 PH:PH3X200,PH2X150,PH1X100 PH0X75,PH2X38 1pc pick up tool 14 in1 screwdriver
--------------------	--------------------------------------------------------------------------------------------------------------------------------------------

21 PCS SCREWDRIVER SET

- Made of hardened chrome vanadium steel
- Matte finish
- Special shape handle in plastic carrying blow case with window



Item no. Contents

23 93 00 46	7 x Hexagon CrV bits 2-6 mm 7 x Tx-star CrV bits T10-T40 3 x flat screwdrivers 8x150, 6x100, 4x75mm 1 insulated electric screwdriver 3x75 mm 2 PH screwdrivers 2#x100 1#x75 mm 1 bits holder driver
--------------------	--------------------------------------------------------------------------------------------------------------------------------------------------------------------------------------------------------------------

42PCS SCREWDRIVER SET

- Made of hardened chrome vanadium steel, matte finish, special shape handle in carrying blow cas



Item no. Contents

23 93 00 47	3 flat screwdriver 6x38, 6x100, 8x150mm 1 flat electric screwdriver 5x75 mm 4 PH screwdriver 2#x38, 1#x75, 2#x100, 3#x150 mm 6 precision screwdrivers: flat: 3.5x50,3.0x50, 2.5x50 mm, PH: 0#x50, 00#x50 mm, Torx: T20x50, T15x50 mm 1 bits holder driver 6 x Tx-star CrV bits: T10, T25, T30, T40. 6 X Hexagon Crv bits: 2, 3, 4, 5, 5.5, 6 mm 4 x PH Crv bits: 0#, 1#, 2#, 3# ^{T15} 5 x flat CrV bits: 3, 4, 5, 6 mm 4 x poz CrV bits: 0#, 1#, 2#, 3# 1 x flexible extension.
--------------------	------------------------------------------------------------------------------------------------------------------------------------------------------------------------------------------------------------------------------------------------------------------------------------------------------------------------------------------------------------------------------------------------------------------------------------------------------------------------------------------------------------------------

41-PCS. PROFESSIONAL SCREWDRIVER SET

- All parts Made of Chrome-Vanadium steel
- In blue colored window blow mould case



Item no. Contents

23 93 00 48	1pc. 225 mm magnetic screwdriver handle for 1/4" hex shank bits -blade in satin chrome plated 1pc. telescopic magnetic pick up tool extendable to 550 mm 2pcs. precision screwdrivers 1pcs. SL 2,0 x 125 mm 1pcs. PH #00 x 125 mm, blades in black finish 5pcs. insulated screwdrivers, red insulation 3pcs. SL 3 x 170 mm SL 4 x 225 mm SL 5 x 260 mm, blades in black finish with magnetic tip 2pcs. PH #0 x 160 mm PH #1 x 200 mm, blades in black finish, with magnetic tip 7pcs. screwdrivers, blades in satin, chrome finish 3pcs. SL 5,5 x 225 mm SL 6,5 x 260 mm, SL 8 x 330 mm, with black magnetic tip 4pcs. PH #2 x 110 mm, PH #0 x 160 mm, PH #1 x 175 mm, PH #2 x 225 mm, with black magnetic tip 25pcs. 1/4" bits, black finish, CR-V length of bits: 25 mm 5pcs. SL 3-4-5-6-7 mm 4pcs. PH No.0-No.1-No.2-No.3 4pcs. pozi No.0-No.1-No.2-No.3 6pcs. hex 2-3-4-5-5.5-6 mm 6pcs. torx T10-T15-T20-T25-T30-T40
--------------------	---------------------------------------------------------------------------------------------------------------------------------------------------------------------------------------------------------------------------------------------------------------------------------------------------------------------------------------------------------------------------------------------------------------------------------------------------------------------------------------------------------------------------------------------------------------------------------------------------------------------------------------------------------------------------------------------------------------------------------------------------------------------------------------------------------------------------------------------------------------------------------------------------------------------------------------------------------------------------

27PCS SCREWDRIVER SET + BIT SET

- GS-APPROVAL
- Packed in blow mould case.



Item no. Contents

23 93 00 49	5pcs chrome-vanadium steel screwdriver SL: 4x75 mm, 5.0x100 mm, 8.0x180mm PH: PH 1x75 mm, PH 2X100 mm 1pc bit driver 1pc 60mm voltage tester, GS/CE-approval 6pcs precision screwdriver 14pcs 25mm chrome-vanadium bits, Hex: 2, 2.5, 3, 4, 5, 5.5, 6 mm, Trox: T10, T15, T20, T25, T27, T30, T40.
--------------------	-------------------------------------------------------------------------------------------------------------------------------------------------------------------------------------------------------------------------------------------------------------------------------------------------------------------



45PCS COMBI-TOOL SET

► Packed in blow mould case



Item no.	Contents
23 93 00 50	2pcs pliers, 2 components non-slip handle nickel-plated: 7" combination pliers, 8" snip nose pliers 1pc ratchet bit driver, 2 components non-slip handle 1pc magnetic bit holder 1pc 25mm adaptor 22pcs chrome-vanadium bits PH: 1,2,3, PZ: 1,2,3 TORX: 10, 15, 20, 25, 27, 30, 40 SL: 4, 5, 5.5, 6 HEX: 3, 4, 5, 5.5, 6 12pcs chrome-vanadium sockets: 4, 4.5, 5, 5.5, 6, 7, 8, 9, 10, 11, 12, 13 mm 6pcs screwdriver, 2 components non-slip TPR handle, chrome-vanadium steel blades SL: 5x100, 6x100 mm PH: PH1x75, PH2x100 mm Pozi: PZ1x75, PZ2x100 mm

36PCS SCREWDRIVER + BIT SET

► Packed in blow mold case



Item no.	Contents
23 93 00 52	7pcs precision screwdriver, 2 components non-slip TPR handle, Cr-V steel blade PH00x50mm, PH0x50mm, PH1x50mm, SL2x50mm, SL2.5x50mm, SL3x50mm, SL4x50mm 20pcs 25mm Cr-V bits: SL: 3, 4, 5, 6mm PH: 0, 1, 2, 3 PZ: 0, 1, 2, 3 Hex: 3, 4, 5, 6mm Torx: 10,15,20, 25 5pcs screwdriver with 2 components handle: SL: 3x75mm, 6x100mm, 8x150mm PH: 1x75mm, 2x100mm 2pcs screwdriver with 2 components handle insulated blades: SL5x75mm, PH1x75mm 1pc powerful ratchet handle with 2 components handle. 1pc 190mm black finished elastic shaft.

55PCS TOOL SET



Item no.	Contents
23 93 00 54	12pcs 50mm Cr-V long bits set 4pcs 115mm Cr-V long bits set 2pcs diamond needle file 5pcs 1/4"X38mm 50BV-30 Cr-v steel powersockets with Hex shank Specification: 6/7/8/9/10MM 1pc 60mm magnetic adaptor 6pcs Precision screwdrivers Specification: SL2X50, 2.5X50, 3X50 PH000X50, PH00X50, PH1X50 6pcs screwdrivers, forged Cr-V steel blade Specification: SL3X75, SL4X75, SL6X100, SL8X150 PH0X75, PH2X100 1pc quick bit driver 18pcs 25mm Cr-V bits set

21 SCREWDRIVER AND BITS SET

- Bits are Made of Chrome-Vanadium steel, also can be made of S2 steel
- Hardened and sand-blasting finished
- Screwdriver's blade is made of CR-V steel and hardened, satin finished, with double color handle.
- In blow mould case with window



Item no.	Contents
23 93 00 51	7pcs 25mm long Hex bits: 2mm, 2.5mm, 3mm, 4mm, 5mm, 5.5mm, 6mm 7pcs 25mm long torx bits: T10, T15, T20, T25, T27, T30, T40 1pc insulated electric screwdriver: SL 3 x75mm 2pcs PH screwdrivers: PH1 x 75mm, PH2 x 100mm 3pcs SL screwdrivers: 4 x 75mm, 6 x 100mm, 8 x 150mm 1pc bit holder driver

63PCS TOOL SET



Item no.	Contents
23 93 00 53	30pcs 28mmX4H Cr-V bits, chrome plated with 3pcs plastic bits holders 2pcs stainless tweezers 1pc 90mmX4H adaptor 1pc 4H handle 2pcs 4.5" mini pliers, forged carbon steel, nickel plated 1pc magnifying glass 1pc 100mmX4H flexible shaft 6pcs screwdrivers, Forged Cr-V blade Specification: SL3X75, SL4X75, SL6X100, SL8X150 PH0X75, PH2X100 1pc socket adaptor 18pcs 1/4"X25mm Cr-V bits

44 PCS TOOL SET



Item no.	Contents
23 93 00 55	30pcs bits: sizes: Slot:3,4,5,6,7,8; PH:0,1,2,3; PZ:0,1,2,3; Torx:T10,T15,T20,T25,T30,T40, Square:0,1,2,3 HEX:2,2.5,3,4,5,6mm 7pcs precision screwdrivers, sizes:PH0,00X50mm SL2,2.5,3X50mm TT10,T15X50 6pcs Screwdrivers:SL5.5X75,SL6.5 X100,SL8X150; PH1X75,PH2X100 1pc soft shaft 1pc bit holder

41PCS TOOL SET



Item no.	Contents
23 93 00 56	25pcs bits: sizes:Slot:3,4,5,6,7; PH:0,1,2,3; PZ:0,1,2,3; Torx:T10,T15,T20,T25,T30,T40 HEX:2,3,4,5,5,5,6mm 7pcs precision screwdrivers, sizes:PH0,00X50mm SL2.5,3X50mm T5,T10,T15X50 6pcs Screwdrivers:SL6.5X100, SL6X38,SL8X150 PH2X38,PH3X150,PH2X100 1pc bits holder 2pcs insulated screwdrivers SL5X75,PH2X75

36PCS TOOL SET



Item no.	Contents
23 93 00 60	20pcs 25mm bits: sizes:Slot:3,4,5,6; PH:0,1,2,3; PZ:0,1,2,3; Torx:T10,T15,T20,T25; HEX:3,4,5,6mm 7pcs precision screwdrivers, sizes:PH0,00X50mm SL1.5,2,2.5,3X50mm 5pcs Screwdrivers:SL6.5X100, SL5X75,SL8X150 PH1X75,PH2X100 1pc soft shaft 2pcs insulated screwdrivers SL5X75,PH2X75 1pc ratchet handle

37 PCS TOOL SET

► Packed in blow mould case with transparent window



Item no.	Contents
23 93 00 62	1pc 125mm snip nosepliers 1pc 6" adjustable wrench with red insulation 1 mini-spirit level 1pc bit driver 32pcs 25mm chrome-vanadium bits 1pc magnetic bit holder

49PCS TOOL SET



Item no.	Contents
23 93 00 59	22pcs 25mm bits: sizes:Slot:4,5,6,7; PH:1,2,3; PZ:1,2,3; Torx:T10,T15,T20,T25,T30,T40 HEX:2,2.5,3,4,5,6mm 7pcs precision screwdrivers, sizes:PH0,PH00,Ph000,Ph0000 SL1.5,2,2.5,3X50mm 5pcs Screwdrivers:SL6.5X100,SL5X75,SL8 X150; PH1X75,PH2X100,PH3X100 1pc ratchet handle 1pc precision screwdriver handle 1pc hex and square adaptor 10pcs sockets:4,5,6,7,8,9,10,11,12,13

20 PCS TOOL SET



Item no.	Contents
23 93 00 61	8pcs combination wrenches,chrome- vanadium steel.satin finish:8,9,10,12,13,14,17,19mm 2pcs screwdriver,2 components soft plastic handle satin finished balde with black tip:SL6X100,PH2X100 1pc precision screwdriver,chrome-vanadium balde with black tip:3X75 1pc bit holder drivers with magnetic. 4pcs 25mm chrome-vanadium bits: T10,T15,t20,T25 1pc 6" combination pliers,carbon steel,nickle plated head with 2 component handle 1pc 250mm box joint water pump pliers,carbon steel ,nickle plated with 2 components handle 1pc 300G machinist's hammer fiberglass handle 1pc plastic blow case

34 PCS TOOL SET

► Packed in blow mould case



Item no.	Contents
23 93 00 63	1pc power ratchet handle 2pcs mini-pliers with bi-color dippeden non-slip handle,nickle plated 1pc mini snip nose pliers 1pc side cutting nippers 1pc 60mm magnetic bit holder 6pcs socket:4,5,6,8,10,12mm 19pcs 25mm chrome-vanadium bit: SL:4,5,6 PH:0,1,2,3 PZ:1,2,3 HEX:3,4,5,6 TORX:10,15,20,25 1pc 25mm cr-v adaptor 4pcs Cr-V precision screwdriver: SL:2.5x50,3.0X50mm PH:00X50,0X50mm



40 PCS TOOL SET

► Packed in blow mould case



Item no.	Contents
23 93 00 64	1pc 6" long nose plier, polished head doublecolor mat dipped handle 8pcs hex key 1/16", 5/64", 3/32", 1/8", 5/32", 3/16", 7/32", 1/4". 6pcs precision screwdriver 1.0, 1.4, 2.0, 2.4, 2.9, 3.8mm 1 utility knife 1pc ratchet 1/4" Dr handle 1pc bit extension bar 1pc socket adaptor 1pc bit driver handle with 1/4" de end of the handle 10pcs 25mm Cr-V bits SL: 4, 5, 6, 7 PH: 1, 2, 3 PZ: 1, 2, 3 11pcs sockets: 4, 4.5, 5, 6, 7, 8, 9, 10, 11, 12, 13mm

41 PCS BIT AND SOCKET SET



Item no.	Contents
23 93 00 66	1PCS RATCHET HANDLE 1PC 100 ADAPTOR 1PC SQUARE AND HEX ADAPTOR 14PCS 20 MM SOCKET METRIC: 6/7/8/9/10/11/12 SAE: 3/16"—1/4"—5/16"—11/32"—3/8"—7/16"—1/2" 23PCS 25MM BITS HEX: H1.5/H2/H2.5/H3/H4/H5/H5.5/H6 TORX: T10/T15/T20/T25/T27/T30/T40 SQUARE: S1/S2 PH: PH1/PH2/PH3 SLOT: 5/6/7

40PCS TOOL SET



Item no.	Contents
23 93 00 68	1PC 6" LONG NOSE PLIER 8PCS HEX KEY 1/16", 5/64", 3/32", 1/8", 5/32", 3/16", 7/32", 1/4" 6PCS PRECISION SCREWDRIVER 1, 1.4, 2.0, 2.4, 2.9, 3.8MM 1 UTILITY KNIFE 1PC RATCHET 1/4" HANDLE 1PC BIT EXTENSION BAR 1PC SOCKET ADAPTOR 1PC BIT DRIVER HANDLE WITH 1/4" DREND OF THE HANDLE 10PCS 25MM CR-V BITS SL: 4, 5, 6, 7 PH: 1, 2, 3 PZ: 1, 2, 3 11PCS SOCKETS: 4, 4.5, 5, 6, 7, 8, 9, 10, 11, 12, 13MM

37 PCS TOOL SET

► Packed in blwo mould case with transparent case



Item no.	Contents
23 93 00 65	1pc power ratchet screwdriver handle with 2 components soft grip 1pc 6" adjustable wrench with power comfortable handle 1pc reversible ratchet handle 1/4" with 2 components soft grip 20 Cr-V 25mm bits SL: 3, 4, 5, 6 PH: 1, 2, 3 PZ: 0, 1, 2, 3 Torx: 10, 15, 20, 25 HEX: 3, 4, 5, 6 1pc extension bar 1pc 25mm Cr-V adaptor 12pcs sockets: 4, 4.5, 5, 5.5, 6, 7, 8, 9, 10, 11, 12, 13mm

34PCS BITS AND SOCKETS SET



Item no.	Contents
23 93 00 67	10PCS CR-V 1/4"X25MM BITS SL: 5, 7 PH: 1, 2, 3 PZ: 1, 2, 3 TORX: 15, 20 10PCS CR-V 1/4"X50MM BITS SL: 5, 7 PH: 1, 2, 3 PZ: 1, 2, 3 TORX: 15, 20 11PCS CR-V SOCKETS: 4, 5, 5.5, 6, 7, 8, 9, 10, 11, 12, 13MM 1PC 185MM FLEXIBLE SHAFT 1PC 50MM EXTENSION BAR 1PC UNIVERSAL RATCHET HANDEL

25PCS SCREWDRIVER SET



Item no.	Contents
23 93 00 70	6PCS SOCKETS: 5+6+7+8+9+10MM 1PC T-TYPE RATCHET HANDLE 11PCS 1/4"X50MM BITS: SLOT: 4, 5, 6 PH: PH1, PH2, PH3 PZ: PZ1, PZ2, PZ3 TORX: T15, T20 1PC 50MM SQUARE AND HEX ADAPTOR 6PCS PRECISION SCREWDRIVERS

25PCS SCREWDRIVER SET



Item no.	Contents
23 93 00 71	2PCS PLIERS 1PC STAINLESS TWEEZER 4PCS 1/4" SOCKETS: 7, 8, 9, 10 1PC 75MM SQUARE AND HEX ADAPTOR 1PC PLASTIC MAGNETIC ADAPTOR 9PCS 1/4"X25MM BITS: SLOT: 5, 6 PH: PH1, PH2 PZ: PZ1, PZ2 TORX: T10, T15, T20 1PC SQUARE AND HEX ADAPTOR 6PCS PRECISION SCREWDRIVERS

SCREWDRIVERS,
BITS AND HEXAGON KEYS

11PCS SCREWDRIVER SET

► Canvas bag packing



Item no.	Contents
23 93 00 72	2pcs Phillips screwdriver: PH1X75MM, PH2X100MM 2pcs SL screwdriver: 4x75mm, 6x100mm 2pcs socket screwdriver: 5x75mm, 6x75mm 1pc Torx screwdriver: T15x1 1pc 3-jaws pick-up tools 2pcs tweezers 1pc electronic crimper

45PCS TOOL SET



Item no.	Contents
23 93 00 73	1PC 6" STUBBY ADJUSTABLE WRENCH 1PC 1/4" DR-RATCHET HANDLE 1PC STUBBY POWERFUL RATCHET BIT DRIVER 2PCS PRECISION SCREWDRIVERS 5PCS INSULATED SCREWDRIVER 1000V SL:3X100,4X100,5.5X125MM PH:PH1,PH2 2PCS MINI-PLIERS 1PC 50MM BIT EXTENSION BAR 1PC 65MM BIT EXTENSION BAR 1PC 140MM VOLTAGE TESTER 9PCS SOCKETS:5,6,7,8,9,10,11,12,13MM 20PCS 25MM CR-V BITS: SLOT:3,4,5,6MM PH:0,1,2,3 TORX:10,15,20,25 HEX:3,4,5,6

16PCS PRECISION TOOL KIT

► Packed in nylon zip bag.



Item no.	Contents
23 93 00 74	5pcs Mini pliers with double leaf spring, 2 components handle. Combination plier, long nose plier, side cutter, flat nose plier, end cutter 11pcs precision screwdriver with 2 components handle. SL: 2.5x50mm, 3x50mm PH: PH00x50mm, PH0x50mm Torx: T6x50mm, T7x50mm, T8x50mm, T9x50mm, T10x50mm, T15x50mm, T20x50mm

35PCS SCREWDRIVER SET + BIT SET

► Packed in aluminum case with transparent windows



Item no.	Contents
23 93 00 75	4pcs screwdriver, 2 components Non-slip TPR handle, chrome-vanadium steel blades SL: 5x75, 6x100 mm PH: PH1X75, PH2X100 mm 1pc driver handle 9 chrome-vanadium socket: 5, 6, 7, 8, 9, 10, 11, 12, 13 mm 20pcs 25mm chrome-vanadium bits SL: 3, 4, 5, 6 mm PH: 0, 1, 2, 3 PZ: 0, 1, 2, 3 Hex: 3, 4, 5, 6 mm Torx: 10, 15, 20, 25 1 socket driver adaptor

27PCS SCREWDRIVER SET + BIT SET



Item no.	Contents
23 93 00 76	5PCS SCREWDRIVERS: SLOT:8x150,6.5x100,5x75 PH:PH2X100,PH1X75 1PC INULATED SCREWDRIVER 5X75 1PC BIT HOLDER 20PCS BITS: SLOT:4,5,6,7 PH:0,1,2,3 PZ:0,1,2,3 HEX:4,5,6 TORX:T10/15/20/25/30

47PCS SCREWDRIVER + BIT SET

► Packed in aluminum case.



Item no.	Contents
23 93 00 79	1pc powerful ratchet screwdriver handle 4pcs screwdriver, 2 components Non-slip TPR handle, Cr-V steel blades SL: 5X75mm, 6x100mm PH: PH1x75mm, PH2x100mm 32pcs 25mm Cr-V bits SL: 3, 4, 5, 6, 7 mm PH: 0(x2), 1(x2), 2(x2), 3(x2), PZ: 0(x2), 1(x2), 2(x2), 3(x2) HEX: 2, 2.5, 3, 4, 5, 6mm TORX: 15, 20, 25, 27, 30 9 sockets: 5, 6, 7, 8, 9, 10, 11, 12, 13mm 1pc 60mm magnetic bit holder

65PCS BITS AND TOOLS SET

► Packed in the aluminum case with window



Item no.	Contents
23 93 00 77	16pcs CrV steel 50mm long bits, sand blasting, expert hardened, SL:3-4-5-6-7mm PH:PH0-PH1-PH2-PH3 Torx:T10-T15-T20-T25-T30-T40 1pc 60mm magnetic bit holder 1pc bit driver and adjustable wrench, chrome plated, with double components anti-slip plastic handle 12pcs 25mm CrV sockets: 4-4.5-5-5.5-6-7-8-9-10-11-12-13mm 32pcs 25mm CrV bits: 3-wing:1-2-3-4, 4-wing:6-8-10 SL with central hole:4-6-8-10mm Torx with central hole:8-10-15-20-25-27-30-40 Hex with central hole:2-2.5-3-4-5-6mm SL:5mm,7mm PH:#1,#2 PZ:#1-#2-#3 1pcs 50mm CrV bit adaptor and socket adaptor 1pcs universal adaptor, chrome plated

40PCS PRECISION SCREWDRIVER SET

► New design
► Packed in a aluminum case, with black EVA tray



Item no.	Contents
23 93 00 78	2pcs stainless steel nippers, one with straight tips, 1.2X7.5X120MM, with straight strias one with bent tips, 45°, 1.1X9.5X116MM 2pcs carbon steel pliers, nickel plated, long nose plier 125MM, diagonal plier 110MM 5pcs Bi-color precision screwdriver, blade is made of CRV steel, with magnetic tips, size: T6/T7/T8/T9/T10X50MM 30pcs 4X28MM CRV bits, nickel plated 1pc screwdriver handle with ratchet head



7PCS GO-THROUGH SCREWDRIVERS SET



Item no. Contents

23 93 00 80	Made of Cr-V steel, Hex shank baldes, satin chrome finished. With end knob for striking work Double components anti-slip TPR handle, ergonomically designed 5x75mm, 6x100mm, 8x150mm PH2x38mm, PH1x75mm, PH2x100mm, PH3x150mm
--------------------	----------------------------------------------------------------------------------------------------------------------------------------------------------------------------------------------------------------------------------------

7PCS NUT DRIVER SET



Item no. Contents

23 93 00 82	6mm, 7mm, 8mm, 9mm, 10mm, 11mm, 12mm
--------------------	--------------------------------------

48PCS SCREWDRIVERS & BITS SET



Item no. Contents

23 93 00 84	65PCS COMBINED TOOL SET 1pcs screwdrivers: SL: 6x150mm 5x75mm PH: PH2x100mm PH1x75mm 1pcs stubby H handle 30pcs 25mm bits : SL: 3. 4. 5. 6. 7 PH: PH1、PH2、PH3 PZ: 1. 2. 3 S: S0、S1、S2、S3 ADP TORX: T10、T15、T20、T25、T30、T40 HEX: 2. 2.5. 3. 4. 5. 5.5. 6 9pcs sockets (20mm): 5-13mm 20pcs H4 bits : SL: 1.5. 2.0. 2.5. 3.0. 3.5. 4.0 PH: PH000、PH001、PH1、PH2 PZ: PZ0、PZ1 TORX: T5. T6. T7. T8. T9. T10. T15. T20 1pcs aluminum precision screwdriver handle
--------------------	----------------------------------------------------------------------------------------------------------------------------------------------------------------------------------------------------------------------------------------------------------------------------------------------------------------------------------------------------------------------------------------------------------------------------------------------------------------------------------------------------------------------

18PCS SCREWDRIVERS



Item no. Contents

23 93 00 81	Made of Cr-V steel, Hex shank baldes, satin chrome finished. With end knob for striking work Double components anti-slip TPR handle, ergonomically designed 8pcs screwdrivers: 6x38mm, 5x75mm, 6x8 100mm, 8x150mm PH2x38mm, PH1x75mm, PH2x100mm, PH3x150mm 10pcs precision screwdrivers: 2x50mm, 2.5x50mm, 3x50mm PH00x50mm, PH0x50mm T5x50mm, T6x50mm, T7x50mm, T8x50mm, T9x50mm
--------------------	-----------------------------------------------------------------------------------------------------------------------------------------------------------------------------------------------------------------------------------------------------------------------------------------------------------------------------------------------------------------------------------------------------------

48PCS SCREWDRIVERS & BITS SET



Item no. Contents

23 93 00 83	5pcs screwdrivers: PH1x75mm, PH2x100mm, 6x125mm, 5x100mm, 8x150mm 1pcs Multifunction flask opener 42pcs Combined tool set
--------------------	---------------------------------------------------------------------------------------------------------------------------------

22PCS SCREWDRIVERS & BITS SET



Item no. Contents

23 93 00 85	4pcs screwdrivers: 5x75mm, 6x150mm, PH1x75mm, PH2x100mm 1pcs Multifunction flask opener 17pcs Combined tool set
--------------------	--------------------------------------------------------------------------------------------------------------------------

50PCS SCREWDRIVER & BITS SET



Item no. Contents

23 93 00 86	6pcs screwdrivers: 5x75mm, 6x100mm, 6x150mm, PH0x75mm, PH1x75mm, PH2x100mm 6pcs precision screwdrivers: 1.5x50mm, 2x50mm, 2.5x50mm, 3x50mm, PH00x50mm, PH0x50mm, 9pcs sockets 28pcs bits
--------------------	------------------------------------------------------------------------------------------------------------------------------------------------------------------------------------------------------

44PCS COMINED TOOL SET



Item no.	Contents
23 93 00 87	4pcs precision screwdrivers: 2.0x50mm, 2.5x50mm, PH0x50mm, PH00x50mm 28pcs bits (25mm): SL: 3, 4, 5, 5.5, 6, 7 ADP PH: PH0, PH1, PH2, PH3 PZ: PZ1, PZ2, PZ3 HEX: 2, 2.5, 3, 4, 5, 5.5, 6 TORX: T10, T15, T20, T25, T27, T30, T40 9pcs sockets: 5-13mm 1pcs min long nose pliers 1pcs mini diagonal pliers 1pcs stubby H handle

52PCS SCREWDRIVERS & BITS SET



Item no.	Contents
23 93 00 89	1pcs multifunction flask opener 2pcs "Z" Wrench (PH1-PH2) 6pcs screwdrivers: 3x75mm, 5x75mm, 6x150mm, PH0x75mm, PH1x75mm, PH2x150mm 1pcs screwdriver handle 29pcs bits: SL: 3-4-5-6-7mm PH: PH0-PH1-PH1-PH2-PH2-PH3 PZ: PZ0-PZ1-PZ2-PZ3 HEX: 2.5-3-4-5-6mm TORX: T8-T9-T10-T15-T20-T25-T27-T30-T40 1pcs adaptor 12pcs Scket set

8 IN 1 SCREWDRIVER



Item no.	Contents
23 93 00 91	1pcs screwdriver handle 8pcs CrV blades: 5x105mm-6x105mm, PH1x105mm-PH2x105mm, PZ1x105mm-PZ2x105mm, T15x105mm-T20x105mm

73PCS SCREWDRIVERS & BITS SET



Item no.	Contents
23 93 00 88	1pcs Bit holder (10x75mm) 1pcs pick-up 1pcs torpedo level 5pcs precision screwdrivers: 2.0 x 50mm, 2.5 x 50mm, 3.0 x 50mm, PH00 x 50mm, PH0 x 50mm, 9pcs screwdrivers: 3 x 75mm, 5 x 75mm, 6 x 38mm, 6 x 150mm, 8 x 200mm, PH0 x 75mm, PH1 x 75mm, PH2 x 38mm, PH2 x 100mm 56PCS 25mm Cr-v Bits SL: 3-4-4-4-5-5-5-5-6-6-7mm PH: PH0-PH1-PH1-PH1-PH1-PH2-PH2-PH2-PH2-PH2-PH3-PH3 PZ: PZ0-PZ0-PZ1-PZ1-PZ1-PZ1-PZ2-PZ2-PZ2-PZ2-PZ3-PZ3-PZ3 TORX: T10-T15-T15-T15-T20-T20-T20-T25-T27-T30-T40 HEX: 2-2.5-3-4-5-5-5-6mm

32PCS SCREWDRIVERS & BITS SET



Item no.	Contents
23 93 00 90	7pcs screwdrivers: 5x75mm-6x38mm-6x100mm-8x150mm, PH1x75mm-PH2x38mm-PH2x100mm 8pcs precision screwdrivers: 2.0x75mm-2.5x75mm-3.0x75mm, PH00x75mm-PH0x75mm, T6x75mm-T8x75mm-T10x75mm 16pcs bits: PH0-PH1-PH2-PH3, PZ0-PZ1-PZ2-PZ3, T8-T10-T15-T20-T25-T27-T30-T40

8 IN 1 SCREWDRIVER

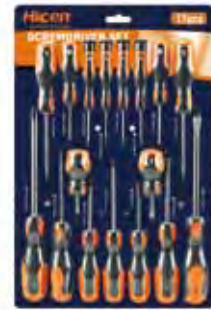

Item no.	Contents
23 93 00 91	1pcs screwdriver handle 8pcs CrV blades: 5x105mm-6x105mm, PH1x105mm-PH2x105mm, PZ1x105mm-PZ2x105mm, T15x105mm-T20x105mm

SCREWDRIVERS,
BITS AND HEXAGON KEYS



SCREWDRIVERS,
BITS AND HEXAGON KEYS

37PCS SCREWDRIVERS & BITS SET



Item no.	Contents
23 93 00 92	8pcs screwdrivers: 6x38mm-5x75mm- 6x100mm-8x150mm PH2x38mm-PH1x75mm- PH2x100mm-PH3x150mm 8pcs precision screwdrivers: 2x50mm-2.5x50mm-3x50mm PH00x50mm-PH0x50mm T6x50mm-T8x50mm-T10x50mm 20pcs bits (L=25mm): SL: 4-4.5-5-5-6mm PH: PH0-PH1-PH1-PH2-PH2-PH3 TORX: T20-T25-T30-T40 HEX: 2-2.5-3-4-5-6mm 1pcs bit holder (10x50mm, shaft length: 75mm)

9PCS SCREWDRIVERS SET



Item no.	Contents
23 93 00 93	6x38mm, 3x75mm, 5x100mm, 6x150mm, 8x150mm PH2x38mm, PH0x75mm, PH1x75mm, PH2x100mm

44PCS SCREWDRIVERS & BITS SET



Item no.	Contents
23 93 00 94	6pcs screwdrivers : 6x38mm, 5x75mm, 6x100mm PH2x38mm, PH1x75mm, PH2x100mm 1pcs bit holder 1pcs magnetic bowl 6pcs sockets set 29pcs bits (L=25mm): SL: 3-4-5-6-7mm PH: PH0-PH1-PH1-PH2-PH2-PH3 PZ: PZ0-PZ1-PZ2-PZ3 TORX: T8-T9-T10-T15- T20-T25-T27-T30-T40 HEX: 2.5-3-4-5-6mm 1pcs adaptor

13PCS SCREWDRIVERS SET



Item no.	Contents
23 93 00 92	3x75mm, 5x100mm, 5x150mm, 6x100mm, 8x150mm PH0x75mm, PH1x150mm, PH2x100mm, PH3x150mm T10x100mm, T15x100mm, T20x100mm, T25x100mm

39PCS SCREWDRIVERS & BITS SET



Item no.	Contents
23 93 00 95	9pcs screwdrivers: 6x38mm-3x75mm-5x100mm- 6x100mm-8x150mm PH2x38mm-PH0x75mm- PH1x100mm-PH3x100mm 9pcs sockets: 5-6-7-8-9-10-11-12-13mm 19pcs bits (L=25mm): SL: 4-6mm PH: PH0-PH1-PH2-PH3 PZ: PZ0-PZ1-PZ2-PZ3 HEX: 3-4-5-6mm TORX: T15-T20-T25-T30-T40 1pcs adaptor 1pcs bit holder

30PCS SCREWDRIVERS & BITS SET



Item no.	Contents
23 93 00 96	8pcs precision screwdrivers: 2x50mm-2.5x50mm-3x50mm PH00x50mm-PH0x50mm T10x50mm-T15x50mm-T20x50mm 5pcs screwdrivers: 5x100mm-6x100mm-8x150mm PH1x75mm-PH2x100mm 1pcs bits holder driver 16pcs bits(L=25mm): SL: 4-6mm PH: PH1-PH2 PZ: PZ1-PZ2 TORX: T10-T15-T20-T25-T27-T30 HEX: 3-4-5-6mm

10PCS SCREWDRIVERS SET



Item no.	Contents
23 93 00 97	5x38mm, 3x50mm, 5x75mm, 6x100mm, 8x150mm PH2x38mm, PH0x50mm, PH1x75mm, PH2x100mm

51PCS SCREWDRIVERS & BITS SET



Item no.	Contents
23 93 00 98	4pcs screwdrivers: 5x75mm, 6x150mm, PH1x75mm, PH2x100mm 1pcs bit holder 18pcs H6 bits (L=25mm): SL: 5-6mm PH: PH0-PH1-PH2-PH3 PZ: PZ0-PZ1-PZ2-PZ3 HEX: 4-5-6mm TORX: T10-T15-T20-T25-T30 2pcs adaptors 20pcs H4 Bits (L=30mm): SL: 1-1.5-2-2.5-3-3.5-4mm PH: PH000-PH00-PH0-PH1 PZ: PZ0-PZ1 TORX: T4-T5-T6-T7-T8-T9-T10 6pcs sockets: 5-6-8-10-11-13mm

51PCS SCREWDRIVERS & BITS SET



Item no.	Contents
23 93 00 99	5pcs screwdrivers: 5x75mm, 6x100mm, 6x150mm, PH1x75mm, PH2x100mm 1pcs ratchet handle 6pcs precision screwdrivers: 3x50mm, 2.5x50mm, 2x50mm, PH0x50mm, PH00x50mm, PH000x50mm 31pcs bits set 2pcs adaptors 6pcs sockets set

5PCS INSULATION SCREWDRIVERS SET



Item no.	Contents
23 93 01 01	4pcs VDE screwdrivers: 1.2x6.5x150mm-1.0x5.5x125mm PH1x80mm-PH2x100mm 1pcs voltage tester (3x140mm): 125V-250V

3PCS VDE SCREWDRIVERS SET



Item no.	Contents
23 93 01 02	0.8x4.0x100mm PH0x60mm-PH1x80mm

7PCS INSULATION SCREWDRIVERS SET



Item no.	Contents
23 93 01 03	6PCS VDE screwdrivers: 1.2x6.5x150mm-1.0x5.5x 125mm-0.8x4.0x100mm PH0x75mm-PH1x80mm- PH2x100mm 1pcs voltage tester (3x140mm): 125V-250V

8 IN 1 SCREWDRIVER



Item no.	Contents
23 93 00 91	1pcs screwdriver handle 8pcs CrV blades: 5x105mm- 6x105mm, PH1x105mm- PH2x105mm, PZ1x105mm- PZ2x105mm, T15x105mm- T20x105mm



SCREWDRIVERS,
BITS AND HEXAGON KEYS

5PCS INSULATION SCREWDRIVERS SET



Item no.	Contents
23 93 01 05	4pcs VDE screwdrivers: 1.2x6.5x150mm- 0.8x4.0x100mm PH1x80mm-PH2x100mm 1pcs voltage tester (3x140mm): 125V-250V

2PCS INSULATION SCREWDRIVERS SET



Item no.	Contents
23 93 01 07	1.0x5.5x125mm, PH2x100mm

9PCS COMBINED TOOL SET



Item no.	Contents
23 93 01 09	1pcs long nose pliers 1pcs diagonal cutting pliers 1pcs magnifying glass 6pcs precision screwdrivers: SL: 2.5X50mm, 3.0X50mm PH: PH00X50mm, PH0X50mm TORX: T8X50mm, T10X50mm

7PCS PRECISION SCREWDRIVERS SET



Item no.	Contents
23 93 01 08	SL: 2.0X50mm, 2,5X 50mm PH: PH00X50mm, PH0X50mm TORX: T8XX50mm, T9XX50mm, T10XX50mm

4PCS INSULATION SCREWDRIVERS SET



Item no.	Contents
23 93 01 06	1.0x5.5x125mm-0.8x4.0x100mm PH1x80mm-PH2x100mm

13 IN 1 RATCHET BITS SET



Item no.	Contents
23 93 01 10	1pcs ratchet handle 1pcs 60mm bit holder 12pcs 25mm Cr-V bits: SL: 5-6mm PH: PH1-PH2 PZ: PZ1-PZ2 HEX: 4-5-6mm TORX: T15-T20-T25

47PCS COMBINATION TOOL SET



Item no.	Contents
23 93 01 11	6pcs precision screwdrivers: 2x50mm-2.5x50mm PH00x50mm-PH0x50mm T10x50mm-T15x50mm 1pcs bit driver 5pcs mini pliers 35pcs bits (L=25mm): SL: 2-2.5-3-4-5-6-7mm PH: PH0-PH1-PH1-PH2-PH2-PH3-PH3 PZ: PZ0-PZ1-PZ1-PZ2-PZ2-PZ3-PZ3 TORX: T10-T15-T20-T25-T27-T30-T40 HEX: 1.5-2-2.5-3-4-5-6mm

7 IN 1 RATCHET BIT SET



Item no.	Contents
23 93 01 12	1pcs ratchet handle 1pcs bit holder 6pcs bits: SL: 5-6mm PH1-PH2 PZ1-PZ2



HEXAGON KEYS SET

10PCS HEX KEY ET ON RING

- ▶ Made of chrome vanadium steel
- ▶ Hardened with chrome/black finished surface



Item no.	Contents
23 96 00 01	10pcs hex key set on ring 1.5,2,2.5,3,4,5,5.5, 6,8,10mm
23 96 00 02	6pcs hex key set on ring 2,2.5,3,4,5,6mm.
23 96 00 03	8pcs hex key set on ring 1.5,2,2.5,3,4,5,5.5,6mm

8PCS HEX KEY SET(METRIC)

- ▶ Made of chrome vanadium steel,
- ▶ Hardened with chrome finished surface
- ▶ Size:1,2,1.5,2,2.5,3,3.5,4,4.5,5,5.5,6mm



Item no.	Contents
23 96 00 06	2,2.5,3,3.5,4,4.5,5,5.5,6mm

10 PCS HEX KEY SET

- ▶ Made of chrome vanadium steel
- ▶ Hardened with nickel plated surface



Item no.	Contents
23 96 00 05	1.5,2,2.5,3,4,5,5.5,6,8,10mm

9 PCS BALL POINT LONG ARM HEX KEY SET

- ▶ Made of chrome vanadium steel,
- ▶ Hardened with zinc plated surface



Item no.	Contents
23 96 00 07	1.5,2,2.5,3,4,5,6,8,10mm

9 PCS EXTRA LONG ARM BALL POINT HEX KEY SET

- ▶ Made of chrome vanadium steel
- ▶ Hardened with satin chrome plated surface



Item no.	Contents
23 96 00 08	1pc handle 1.5,2,3,4,5,6,8,10mm



SCREWDRIVERS,
BITS AND HEXAGON KEYS

9 PCS LONG ARM TORX KEY SET



Item no.	Contents
23 96 00 09	T10,T15,T20,T25,T27,T30,T40,T45,T50

13PCS LONG ARM TORX KEY TEX

- ▶ Made of chrome vanadium steel
- ▶ Hardened with lacquered surface.



Item no.	Contents
23 96 00 10	0.05"-1/16"-5/64"-3/32"-7/64"-1/8"-9/64"-5/32"-3/16"-7/32"-1/4"-5/16"-3/8"

9PCS LONG ARM TORX KEY SET

- ▶ Made of chrome vanadium steel
- ▶ Hardened with lacquered surface



Item no.	Contents
23 96 00 11	T10-T15-T20-T27-T30-T40-T45-T50

7PCS LONG ARM TORX KEY SET

- ▶ Made of chrome vanadium steel
- ▶ Hardened with lacquered surface



Item no.	Contents
23 96 00 12	T9-T10-T15-T20-T25-T27-T30

7PCS LONG ARM BALL POINT-TORX MAGNET KEY SET

- ▶ Made of chrome vanadium steel
- ▶ Hardened with lacquered surface



Item no.	Contents
23 96 00 13	1.5mm/T10,2mm/T15,2.5mm/T20,3mm/T25,4mm/T27,5mm/T30,6mm/T40

9PC EXTRA LONG ARM BALL POINT HEX KEY SET



Item no.	Contents
23 96 00 56	Size:1.5,2,2.5,3,4,5,6,8,10mm Surface:tip satin plating, color rubber coating Laser logo and size marking

9PC LONG ARM BALL POINT HEX KEY SET



Item no.	Contents
23 96 00 57	Size:1/16",5/64",3/32",1/8",5/32",3/16",1/4",5/16",3/8" Surface: tip satin plating, color rubber coating Laser logo and size marking



9PC SHORT ARM TORX KEY SET



Item no.	Contents
23 96 00 58	Size: T10, T15, T20, T25, T27, T30, T40, T45, T50 Surface: tip satin plating, color rubber coating Laser logo and size marking

9PC EXTRA LONG ARM BALL POINT HEX KEY SET



Item no.	Contents
23 96 00 59	Size: 1.5,2,2.5,3,4,5,6,8,10mm Surface: colorful coating

10PC LONG ARM BALL POINT HEX KEY SET



Item no.	Contents
23 96 00 60	Size:1.27,1.5,2,2.5,3,4,5,6,8 Surface: Satin finish Material:CR-V

10PC EXTRA LONG ARM BALL POINT HEX KEY SET



Item no.	Contents
23 96 00 61	Size:1.27,1.5,2,2.5,3,4,5,6,8 Surface: Satin finish Material:CR-V

10PC SHORT ARM BALL POINT HEX KEY SET



Item no.	Contents
23 96 00 62	Size:1.27,1.5,2,2.5,3,4,5,6,8 Surface: Satin finish Material:CR-V

25PC HEX KEY SET



Item no.	Contents
23 96 00 63	13pc SAE hex key:0.05"/1/16"-5/64"-3/32"-7/64"-1/8"-9/64"-5/32"-3/16"-7/32"-1/4"-5/16"-3/8" 12pc Metric hex key: 1.27-1.5-2-2.5-3-4-5-6-7-8-9-10mm Material:CR-V

17PCS HEX KEY AND STAR DRIVER SET

- ▶ Made of chrome vanadium steel
- ▶ Hardened with lacquered surface



Item no.	Contents
23 96 00 14	9pcs ball end hex key:1.5,2,2.5,3,4,5,6,8,10mm 8pcs torx driver:T8,T10,T15,T20,T25,T27,T30,T40

18PCS HEX KEY AND STAR DRIVER SET

- ▶ Made of chrome vanadium steel
- ▶ Hardened with satin finished surface



Item no.	Contents
23 96 00 15	9pcs ball end hex key:1.5,2,2.5,3,4,5,6,8,10mm 9pcs torx driver:T8,T15,T20,T25,T27,T30,T40,T45,T50

17PCS BALL POINT HEX KEY AND STAR DRIVER SET

- ▶ Made of chrome vanadium steel
- ▶ Hardened with satin finished surface



Item no.	Contents
23 96 00 16	9pcs ball point hex key:1.5mm,2mm,2.5mm,3mm,4mm,5mm,6mm,8mm,10mm 8pcs torx key:T9/10/15/20/25/27/30/40

22PCS LONG ARM BALL POINT HEX KEY SET

- ▶ Made of chrome vanadium steel
- ▶ Hardened with black finished



Item no.	Contents
23 96 00 17	8 bits size includes 3pcs phillips:#0,#1,#2 3pcs slotes:4,5,6mm 2pcs torx:T10,T15 13pcs long arm ball point hex key set,black finished: Metric:1.5,2,2.5,3,4,4.5,5,5.5,6,7,8,9,10mm 1pc ratchet handle

9PCS HEX KEY SET DIN911

- ▶ Made of chrome vanadium steel
- ▶ Hardened with black finished surface



Item no.	Contents
23 96 00 18	Hex:1.5,2,2.5,3,4,5,6,8,10mm Torx:T10,T15,T20,T25,T27,T30,T40,T45,T50 Ball point 1.5,2,2.5,3,4,5,6,8,10mm

30PCS COMBINATION HEX KEY SET

- ▶ Made of chrome vanadium steel
- ▶ Hardened with black finished surface



Item no.	Contents
23 96 00 19	15pcs metric sizes short arm series:0.7,0.9,1.3,1.5,2,2.5,3,4,4.5,5,5.5,6,7,8,9,10mm 15pcs sae sizes long arm series:0.028",0.035",0.005",1/16",5/64",3/32",7/64",1/8",9/64",5/32",3/16",7/32",1/4",5/16",3/8"



18PCS COMBO HEX KEY SET(METRIC AND TORX)

- ▶ Made of chrome vanadium steel
- ▶ Hardened with satin chrome finished surface
- ▶ Short arm hex key series



Item no.	Contents
23 96 00 20	Hex:1.5,2,2.5,3,4,5,6,10mm Torx:T10,T15,T20,T27,T30,T40,T45,T50

15PCS JUMBO AND FOLDING HEX KEY SET IN METAL CASE

- ▶ Made of chrome vanadium steel
- ▶ Hardened with black finished surface



Item no.	Contents
23 93 00 23	8pcs Hex key:3,4,5,6,8,10,12,14mm 7pcs folding set 1/8",5/32", 3/16",1/4",5/16",3/8",1/2",9/16"

8PCS HEX KEY SET

- ▶ Made of chrome vanadium steel
- ▶ Hardened with black finished surface,
- ▶ With 2 component shell.



Item no.	Contents
23 96 00 27	

18PCS COMBO HEX KEY SET(SAWE AND TORX)

- ▶ Made of chrome vanadium steel,hardened with satin chrome plated surface
- ▶ Short arm hex key series



Item no.	Contents
23 93 00 21	Hex(SAE):1/16",5/64",3/32", 1/8",5/32",3/16",1/4",5/16",3/8" Short arm Torx Size:T10,T15, T20,T25,T27,T30,T40,T45,T50

8PCS FOLDING HEX KEY SET

- ▶ Made of chrome vanadium steel
- ▶ Hardened with black finished surface



Item no.	Contents
23 96 00 24	T9,T10,T15,T20,T25,T27,T30,T40

7PCS BALL POINT HEX KEY SET

- ▶ Made of chrome vanadium steel
- ▶ Hardened with zinc plated surface



Item no.	Contents
23 96 00 28	2,2.5,3,4,5,6,8mm

9 PCS BALL POINT LONG ARM HEX KEY SET

- ▶ Made of chrome vanadium steel,hardened with black finished surface



Item no.	Contents
23 96 00 29	Hex(Metric): 1.5,2,2.5,3,4,5,5.5,6mm Hex(SAE) :5/64",3/32",7/64", 1/8",9/64",5/32",3/16",7/32",1/4".

10PCS HEX KEY SET IN METAL CASE

- ▶ Made of chrome vanadium steel
- ▶ Hardened with satin chrome plated surface



Item no.	Contents
23 93 00 22	Hex(Metric):3,4,5,5.5,6,8, 10,12,14,17mm Hex(SAE):1/8",5/32",3/16",7/32", 1/4",5/16",3/8",1/2",9/16",5/8"

8PCS FOLDING HEX KEY SET

- ▶ Made of chrome vanadium steel
- ▶ Hardened with satin chrome plated surface



Item no.	Contents
23 96 00 25	1.5,2,2.5,3,4,5,6,8mm.

2PCS HEX KEY AND TORX KEY SET

- ▶ Made of chrome vanadium steel
- ▶ Hardened with satin chrome finished surface.



Item no.	Contents
23 96 00 30	Hex:/size:2,2.5,3,4,5,6,7,8mm Torx:T9,T10,T15,T20,T25, T27,T30,T40.T9-T40

SCREWDRIVERS,
BITS AND HEXAGON KEYS

8PCS FOLDING TORX KEY SET

- ▶ Made of chrome vanadium steel
- ▶ Hardened with satin chrome finished surface



Item no.	Contents
23 96 00 31	Hex key: 1.5, 2, 2.5, 3, 4, 5, 6, 8mm Torx key: T9, T10, T15, T20, T25, T27, T30, T40 Ball point: 1.5, 2, 2.5, 3, 4, 5, 6, 8mm

3PCS FOLDING HEX KEY COMBINATION SET (HEX KEY, BALL HEAD, TORX)

- ▶ Made of chrome vanadium steel
- ▶ Hardened with satin chrome finished surface.



Item no.	Contents
23 96 00 32	Hex key: 1.5, 2, 2.5, 3, 4, 5, 6, 8mm; Torx: T9, T10, T15, T20, T25, T27, T30, T40; Ball head: 1.5, 2, 2.5, 3, 4, 5, 6, 8mm.

3PCS HANDY HEX KEY COMBO SET

- ▶ Made of chrome vanadium steel
- ▶ Hardened with satin chrome finished surface.



Item no.	Contents
23 96 00 33	SAE: 5/64", 3/32", 7/64", 1/8", 9/64", 5/32", 3/16", 7/32", 1/4" Metric: 1.5, 2, 2.5, 3, 3.5, 4, 5, 5.5, 6

8PCS HEX KEY SET

- ▶ Made of chrome vanadium steel
- ▶ Hardened with zinc plated



Item no.	Contents
23 96 00 34	1.5, 2, 2.5, 3, 4, 5, 5.5, 6mm

9PCS FOLDING HEX KEY SET

- ▶ Made of chrome vanadium steel
- ▶ Hardened with satin chrome finished surface
- ▶ With aluminum handle



Item no.	Contents
23 96 00 35	1/16", 5/64", 3/32", 7/64", 1/8", 9/64", 5/32", 3/16", 1/4"

8PCS FOLDING TORX KEY SET

- ▶ Made of chrome vanadium steel
- ▶ Hardened with satin chrome finished surface
- ▶ With aluminum handle



Item no.	Contents
23 96 00 36	T9, T10, T15, T20, T25, T27, T30, T40

7PCS FOLDING BALL POINT HEX KEY SET

- ▶ Made of chrome vanadium steel
- ▶ Hardened with satin chrome finished surface
- ▶ With aluminum handle



Item no.	Contents
23 96 00 37	1.5, 2, 2.5, 3, 4, 5, 6mm

8PCS FOLDING BALL POINT HEX KEY SET

- ▶ Made of chrome vanadium steel
- ▶ Hardened with satin chrome finished surface
- ▶ With aluminum handle



Item no.	Contents
23 96 00 41	1.5, 2, 2.5, 3, 4, 5, 6, 8mm

8PCS FOLDING TORX KEY SET

- ▶ Made of chrome vanadium steel
- ▶ Hardened with satin chrome finished surface.
- ▶ With aluminum handle



Item no.	Contents
23 96 00 42	T8, T9, T10, T15, T20, T25, T27, T30



9PCS FOLDING HEX KEY SET

- ▶ Made of chrome vanadium steel
- ▶ Hardened with satin chrome finished surface.
- ▶ With aluminum handle



Item no.	Contents
23 96 00 43	1/16", 5/64", 3/32", 7/64", 1/8", 9/64", 5/32", 3/16", 1/4"

6PCS FOLDING SCREWDRIVER SET

- ▶ Made of chrome vanadium steel
- ▶ Hardened with satin chrome finished surface.
- ▶ With aluminum handle.



Item no.	Contents
23 96 00 44	PH0, PH1, PH2, SL3, SL4, SL5.

4PCS FOLDING HEX KEY SET

- ▶ Made of chrome vanadium steel
- ▶ Hardened with satin chrome finished surface.
- ▶ With aluminum handle.



Item no.	Contents
23 96 00 45	Ball point hex key set, SAE sizes: 1/6", 5/64", 3/32", 3/16", 1/4" Ball point hex key set, Metric sizes: 1.5, 2, 2.5, 3, 4, 5, 6mm. Torx key set, torx sizes: T6, T7, T8, T9, T10, T15, T20, T25.

T-HANDLE HEX KEY WRENCH

- ▶ Made of chrome vanadium steel
- ▶ Hardened with chrome finished surface
- ▶ With plastic handle



Item no.	Contents
23 96 00 46	H2/2.5/3/4/5/6/8/10

T-HANDLE TORX & BALL POINT HEX WRENCH



Item no.	Contents
23 96 00 47	(T10/T15/T20)X100 (H4/H5/H6)X150 (H8/ H10/ H12)X200

T-HANDLE HEX KEY/TORX/SOCKET SET

- ▶ Made of chrome vanadium steel
- ▶ Hardened with satin chrome finished surface
- ▶ With PP+TPR handle



Item no.	Contents
23 96 00 48	Hex: h2/2.5/3/4/5/6/8/10 Torx: t6/7/8/9/10/15/20/25/27/30/40/45/50/55 socket: 4/4. 5/5/5. 5x125mm 6/7/8/9/10/11/12/13x230mm 10/13x350mm

10PCS T-HANDLE HEX KEY SET

- ▶ Made of chrome vanadium steel
- ▶ Hardened with black finished surface.
- ▶ With aluminum handle.



Item no.	Contents
23 96 00 49	2, 2.5, 3, 4, 4.5, 5, 5.5, 6, 8, 10mm

8PCS T-HANDLE HEX KEY SET

- ▶ Made of chrome vanadium steel
- ▶ Hardened with satin chrome plated
- ▶ With PP handle



Item no.	Contents
23 96 00 50	2x100, 2.5x100, 3x100, 4x100, 5x150, 6x150, 8x200, 10x200

T-HANDLE HEX KEY WRENCH SET

- ▶ Made of chrome vanadium steel
- ▶ Hardened with satin chrome finished surface
- ▶ With PP+TPR handle



Item no.	Contents
23 96 00 51	Metric: 3, 4, 4.5, 5, 6, 8, 10mm SAE: 1/8", 9/64", 5/32", 3/16", 1/4", 3/8", 5/16"

7PCS T-HANDLE HEX KEY SET

- ▶ Made of chrome vanadium steel
- ▶ Hardened with satin chrome finished surface



Item no.	Contents
23 96 00 52	2.5,3,4,5,6,8,10mm

16PCS T-HANDLE TORX & BALL POINT HEX SCREWDRIVER SET

- ▶ Made of chrome vanadium steel
- ▶ Hardened with satin chrome plated surface
- ▶ TPR+PP handle



Item no.	Contents
23 96 00 55	Hex:2x75mm,2.5x75mm,3x100mm,4x100mm, 5x150mm, 6x150mm,8x200mm,10x200mm Torx:T-10x75MM,T-15x75MM, T-20x75MM,T-25x100MM,T-30x150MM, T-4x150MM,T-45x200MM,T-50x200MM

8PCS T-HANDLE HEX KEY WRENCH SET/METRIC

- ▶ Made of chrome vanadium steel
- ▶ Hardened with satin chrome plated surface
- ▶ TPR+PP handle



Item no.	Contents
23 96 00 53	2-2.5-3-4-5-6-8-10mm

3PCS CROSS WRENCH SET



Item no.	Contents
23 96 00 64	1pc zinc die-casting cross wrench 1pc double end slot bit 1pc plastic adaptor

16PCS T-HANDLE TORX & BALL POINT HEX SCREWDRIVER SET

- ▶ Made of chrome vanadium steel
- ▶ Hardened with satin chrome plated surface
- ▶ TPR+PP handle



Item no.	Contents
23 96 00 54	HEX:H2x75,H2.5x75,H3x100 H4x100,H5x150,H6x150, H8x200,H10x200 Torx: T10x75,T15x75, T20x100,T25x100,T30x150, T40x150,T45x200,T50x200



MEASURING TAPE

- ▶ Non-slip and comfort rubber coated ABS case with positive blade locking button and belt clip.
- ▶ Elastic bumpers for longer hook life.



Item no.	Contents
30 20 00 01	2M/6ftx13mm
30 20 00 02	3M/10ftx13mm
30 20 00 03	3M/10ftx19mm
30 20 00 04	5M/16ftx19mm
30 20 00 05	7.5M/25ftx25mm
30 20 00 06	10M/33ftx25mm

MEASURING TAPE

- ▶ Rubber cover, selflock, shockproof, belt clip
- ▶ Nylon coated blades and magnets are optional parts available with cost



Item no.	Contents
30 20 00 07	2M/6ftx16mm
30 20 00 08	3M/10ftx16mm
30 20 00 09	3.5M/12ftx16mm
30 20 00 10	5M/16ftx19mm
30 20 00 11	5M/16ftx25mm
30 20 00 12	5.5M/18ftx25mm
30 20 00 13	7.5M/18ftx25mm
30 20 00 14	8M/26ftx25mm

MEASURING TAPE

- ▶ Covered with rubber coat, gives non-slip grip and greater comfort.
- ▶ Moveable hook, accurate for internal and external measurement



Item no.	Contents
30 20 00 15	2M/6ftx13mm
30 20 00 16	3M/10ftx13mm
30 20 00 17	3M/10ftx19mm
30 20 00 18	5M/16ftx19mm
30 20 00 19	7.5M/25ftx25mm
30 20 00 20	10M/33ftx25mm

MEASURING TAPE

- ▶ Covered with rubber coat, gives non-slip grip and greater comfort.
- ▶ Moveable hook, accurate for internal and external measurement



Item no.	Contents
30 20 00 21	2M/6ftx16mm
30 20 00 22	3M/10ftx16mm
30 20 00 23	3.5M/12ftx16mm
30 20 00 24	3.5Mx16mm
30 20 00 25	5M/16ftx19mm
30 20 00 26	5M/16ftx25mm
30 20 00 27	5.5M/18ftx19mm
30 20 00 28	7.5M/25ftx25mm
30 20 00 29	8M/26ftx25mm



MEASURING TAPE

- ▶ ABS housing with positive blade blocking button;
- ▶ Non-slip and comfort rubber coated;
- ▶ Elastic bumpers for longer hook life



Item no.	Contents
30 20 00 30	2M/6ftx13mm
30 20 00 31	3M/10ftx13mm
30 20 00 32	3M/10ftx16mm
30 20 00 33	5M/16ftx19mm
30 20 00 34	5M/16ftx25mm
30 20 00 35	7.5M/25ftx25mm
30 20 00 36	10M/33ftx25mm

MEASURING TAPE

- ▶ Covered with rubber coat, gives non-slip grip and greater comfort.
- ▶ Moveable hook, accurate for internal and external measurement



Item no.	Contents
30 20 00 38	2M/6ftx16mm
30 20 00 39	3M/10ftx16mm
30 20 00 40	3.5M/12ftx16mm
30 20 00 41	5M/16ftx19mm
30 20 00 42	5M/16ftx25mm
30 20 00 43	5.5M/18ftx25mm
30 20 00 44	7.5M/25ftx25mm
30 20 00 45	8M/26ftx25mm
30 20 00 46	10M/33ftx25mm

MEASURING TAPE

- ▶ Covered with rubber coat, gives non-slip grip and greater comfort.
- ▶ Moveable hook, accurate for internal and external measurement



Item no.	Contents
30 20 00 47	3M/10ftx16mm
30 20 00 48	5M/16ftx19mm
30 20 00 49	7.5M/25ftx25mm

MEASURING TAPE

- ▶ Stainless steel alloy case
- ▶ Co-molded rubber case for comfortable grip and durability
- ▶ Nylon coated blades and magnets are optional parts available with cost



Item no.	Contents
30 20 00 60	2M/6ftx16mm
30 20 00 61	3M/10ftx16mm
30 20 00 62	3.5M/12ftx16mm
30 20 00 63	5M/16ftx19mm
30 20 00 64	5M/16ftx25mm
30 20 00 65	5.5M/18ftx25mm
30 20 00 66	7.5M/25ftx25mm
30 20 00 67	8M/26ftx25mm

MEASURING TAPE

- ▶ Stainless steel alloy case
- ▶ Ergonomically designed case for comfortable grip
- ▶ Self-locking mechanism allows blade to be extended smoothly
- ▶ Nylon coated blades and magnets are optional parts available with cost



Item no.	Contents
30 20 00 68	2M/6ftx16mm
30 20 00 69	3M/10ftx16mm
30 20 00 70	3.5M/12ftx16mm
30 20 00 71	5M/16ftx19mm
30 20 00 72	5M/16ftx25mm
30 20 00 73	5.5M/18ftx25mm
30 20 00 74	7.5M/25ftx25mm
30 20 00 75	8M/26ftx25mm

MEASURING TAPE

- ▶ Rubberized ABS case for non-slip and comfortable grip, with blade locking button and belt clip.



Item no.	Contents
30 20 00 77	2M/6ftx13mm
30 20 00 78	3M/10ftx13mm
30 20 00 79	3M/10ftx16mm
30 20 00 80	5M/16ftx16mm
30 20 00 81	5M/16ftx19mm
30 20 00 82	7.5M/25ftx25mm
30 20 00 83	10M/33ftx25mm

MEASURING TAPE

- ▶ ABS case, with blade locking button and belt clip.



Item no.	Contents
30 20 00 84	2M/6ftx16mm
30 20 00 85	3M/10ftx16mm
30 20 00 86	3M/10ftx19mm
30 20 00 87	5M/16ftx16mm
30 20 00 88	5M/16ftx19mm
30 20 00 89	7.5M/25ftx25mm

MEASURING TAPE

- ▶ ABS case, with blade locking button and belt clip.



Item no.	Contents
30 20 01 01	2M/6ftx16mm
30 20 01 02	3M/10ftx16mm
30 20 01 03	3.5M/12ftx16mm
30 20 01 04	5M/16ftx19mm
30 20 01 05	5M/16ftx25mm
30 20 01 06	5.5M/18ftx25mm
30 20 01 07	7.5M/25ftx25mm
30 20 01 08	8M/26ftx25mm
30 20 01 09	8M/26ftx25mm
30 20 01 10	8M/26ftx25mm
30 20 01 11	8M/26ftx25mm

MEASURING TAPE

- ▶ ABS case, with blade locking button and belt clip.



Item no.	Contents
30 20 01 12	2M/6ftx12.5mm
30 20 01 13	3M/10ftx12.5mm
30 20 01 14	2M/6ftx16mm
30 20 01 15	3M/10ftx16mm
30 20 01 16	3M/10ftx19mm
30 20 01 17	5M/16ftx26mm
30 20 01 18	5M/16ftx19mm
30 20 01 19	7.5M/25ftx19mm
30 20 01 20	7.5M/25ftx25mm
30 20 01 21	8M/26ftx25mm
30 20 01 22	10M/33ftx25mm

MEASURING TAPE

- ▶ ABS case, with blade locking button and belt clip.



Item no.	Contents
30 20 01 12	2M/6ftx12.5mm
30 20 01 13	3M/10ftx12.5mm
30 20 01 14	2M/6ftx16mm
30 20 01 15	3M/10ftx16mm
30 20 01 16	3M/16ftx16mm
30 20 01 17	5M/16ftx26mm
30 20 01 18	5M/16ftx19mm
30 20 01 19	7.5M/25ftx19mm
30 20 01 20	7.5M/25ftx25mm
30 20 01 21	8M/26ftx25mm
30 20 01 22	10M/33ftx25mm

MEASURING TAPE

- ▶ ABS case, with blade locking button and belt clip.



Item no.	Contents
30 20 00 77	2M/6ftx13mm
30 20 00 78	3M/10ftx13mm
30 20 00 79	3M/10ftx16mm
30 20 00 80	5M/16ftx16mm
30 20 00 81	5M/16ftx19mm
30 20 00 82	7.5M/25ftx25mm
30 20 00 83	10M/33ftx25mm

MEASURING TAPE

- ▶ Co-molded rubber case for comfortable grip and durability
- ▶ Moveable hook, accurate for internal and external measurement.
- ▶ With 2 locking button



Item no.	Contents
30 20 00 77	2M/6ftx13mm
30 20 00 78	3M/10ftx13mm
30 20 00 79	3M/10ftx16mm
30 20 00 80	5M/16ftx16mm
30 20 00 81	5M/16ftx19mm
30 20 00 82	7.5M/25ftx25mm
30 20 00 83	10M/33ftx25mm



MEASURING TAPE

- ▶ Self-locking, nylon coated blades and magnets are optional parts available for all tapes with cost.



Item no.	Contents
30 20 01 46	2M/6ftx16mm
30 20 01 47	3M/10ftx16mm
30 20 01 48	3.5M/12ftx16mm
30 20 01 49	5M/16ftx19mm
30 20 01 50	5M/16ftx25mm
30 20 01 51	5.5M/18ftx25mm
30 20 01 52	7.5M/25ftx25mm
30 20 01 53	8M/26ftx25mm

MEASURING TAPE

- ▶ Ergonomically designed case for comfortable grip
- ▶ Self-locking mechanism allows blade to be extended smoothly
- ▶ Nylon coated blades and magnets are optional parts available with cost



Item no.	Contents
30 20 01 64	2M/6ftx16mm
30 20 01 65	3M/10ftx16mm
30 20 01 66	3.5M/12ftx16mm
30 20 01 67	5M/16ftx19mm
30 20 01 68	5.5M/18ftx25mm
30 20 01 69	7.5M/25ftx25mm
30 20 01 70	8M/26ftx25mm

MEASURING TAPE

- ▶ Co-molded rubber case for comfortable grip and durability
- ▶ Moveable hook, accurate for internal and external measurement
- ▶ With 2 locking button



Item no.	Contents
30 20 01 87	3M/10ftx16mm
30 20 01 88	5M/16ftx19mm
30 20 01 89	5M/16ftx25mm
30 20 01 90	7.5M/25ftx25mm

MEASURING TAPE

- ▶ Co-molded rubber case for comfortable grip and durability
- ▶ Moveable hook, accurate for internal and external measurement
- ▶ With 3 locking button



Item no.	Contents
30 20 01 92	3M/10ftx12.5mm
30 20 01 93	3M/10ftx16mm
30 20 01 94	5M/16ftx19mm
30 20 01 95	5M/16ftx25mm
30 20 01 96	7.5M/25ftx25mm
30 20 01 97	10M/33ftx25mm

MEASURING TAPE

- ▶ Co-molded rubber case for comfortable grip and durability
- ▶ Moveable hook, accurate for internal and external measurement
- ▶ With 2 locking button



Item no.	Contents
30 20 01 54	3M/10ftx16mm
30 20 01 55	5M/16ftx19mm
30 20 01 56	5M/16ftx25mm
30 20 01 57	7.5M/25ftx25mm

MEASURING TAPE

- ▶ Ergonomically designed case for comfortable grip
- ▶ Self-locking mechanism allows blade to be extended smoothly
- ▶ Nylon coated blades and magnets are optional parts available with cost



Item no.	Contents
30 20 01 71	3M/10ftx16mm
30 20 01 72	5M/16ftx19mm
30 20 01 73	5M/16ftx25mm
30 20 01 74	7.5M/25ftx25mm

MEASURING TAPE

- ▶ Co-molded rubber case for comfortable grip and durability
- ▶ Moveable hook, accurate for internal and external measurement
- ▶ With 3 locking button



Item no.	Contents
30 20 02 01	2M/6ftx13mm
30 20 02 02	3M/10ftx16mm
30 20 02 03	5M/16ftx19mm
30 20 02 04	5M/16ftx25mm
30 20 02 05	7.5M/25ftx25mm
30 20 02 06	10M/33ftx25mm

MEASURING TAPE

- ▶ Co-molded rubber case for comfortable grip and durability
- ▶ Moveable hook, accurate for internal and external measurement
- ▶ With 2 locking button



Item no.	Contents
30 20 01 58	3M/10ftx16mm
30 20 01 59	3.5M/12ftx16mm
30 20 01 60	5M/16ftx19mm
30 20 01 61	5.5M/18ftx25mm
30 20 01 62	7.5M/25ftx25mm
30 20 01 63	8M/26ftx25mm

MEASURING TAPE

- ▶ Rubberized ABS case for non-slip and comfort grip, with 2 blade locking button and belt clip, bottom stopper to control tape recoil speed.



Item no.	Contents
30 20 01 76	2M/6ftx13mm
30 20 01 77	3M/10ftx13mm
30 20 01 78	5M/16ftx19mm
30 20 01 79	7.5M/25ftx25mm

MEASURING TAPE

- ▶ ABS case, with 3 blade locking button and belt clip.



Item no.	Contents
30 20 01 81	2M/6ftx16mm
30 20 01 82	3M/10ftx16mm
30 20 01 83	5M/16ftx19mm
30 20 01 84	7.5M/25ftx25mm
30 20 01 85	8M/26ftx25mm

MEASURING TAPE

- ▶ Co-molded rubber case for comfortable grip and durability
- ▶ Moveable hook, accurate for internal and external measurement
- ▶ With 3 locking button



Item no.	Contents
30 20 02 07	2M/6ftx16mm
30 20 02 08	3M/10ftx16mm
30 20 02 09	5M/16ftx19mm
30 20 02 10	5M/16ftx25mm
30 20 02 11	7.5M/25ftx25mm
30 20 02 12	10M/33ftx25mm



MEASURING TAPE

- ▶ Chrome plated ABS case, with blade locking button and belt clip.



Item no.	Contents
30 20 02 14	2M/6ftx12.5mm
30 20 02 15	3M/10ftx12.5mm
30 20 02 16	3M/10ftx16mm
30 20 02 17	5M/16ftx16mm
30 20 02 18	5M/16ftx19mm
30 20 02 19	7.5M/25ftx25mm

MEASURING TAPE

- ▶ Chrome plated ABS case, with blade locking button and belt clip.



Item no.	Contents
30 20 02 21	2M/6ftx12.5mm
30 20 02 22	3M/10ftx12.5mm
30 20 02 23	3M/10ftx16mm
30 20 02 24	5M/16ftx16mm
30 20 02 25	5M/16ftx19mm
30 20 02 26	7.5M/25ftx25mm
30 20 02 27	10M/33ftx25mm

CLEARVIEW CASE MEASURING TAPE



Item no.	Contents
30 20 02 29	2Mx16mm
30 20 02 30	3Mx16mm
30 20 02 31	3.5Mx16mm
30 20 02 32	5Mx19mm
30 20 02 33	5.5Mx19mm
30 20 02 34	7.5Mx25mm
30 20 02 35	8Mx25mm

MULTI-FUNCTION MEASURING TAPE

- ▶ The tape with ball-pen & "MEMO"
- ▶ With vial



Item no.	Contents
30 20 02 44	2M/6ftx13mm
30 20 02 45	3M/10ftx13mm
30 20 02 46	3.5M/12ftx13mm

MEASURING TAPE

- ▶ Non-slip and comfortable rubber coated ABS case
- ▶ With magnet for hanging
- ▶ With light for clear reading in dark working area
- ▶ With level for correct measuring, With clip belt



Item no.	Contents
30 20 02 49	7.5Mx25mm

MEASURING TAPE



Item no.	Contents
30 20 02 50	5Mx25mm

MEASURING TAPE

- ▶ Nylon coated blades and magnets are optional parts available for all tapes with cost.



Item no.	Contents
30 20 02 51	7.5Mx25mm
30 20 02 52	8Mx25mm

MEASURING TAPE

- ▶ Measuring tape
- ▶ Professional chrome plated metal protector
- ▶ Twice-moulded case
- ▶ With two brakes



Item no.	Contents
30 20 02 53	3Mx16mm
30 20 02 54	5Mx19mm

MEASURING TAPE

- ▶ Co-molded rubber case for comfortable grip
- ▶ Moveable hook, accurate for internal and external measurement



Item no.	Contents
30 20 03 01	2M/6ftx16mm
30 20 03 02	3M/10ftx16mm
30 20 03 03	5M/16ftx19mm
30 20 03 04	5M/16ftx25mm
30 20 03 05	7.5M/25ftx25mm

RUBBER JACKET MEASURING TAPE

- ▶ ABS case with rubber coat
- ▶ Self-locking mechanism
- ▶ With two magnet on hook



Item no.	Contents
30 20 03 06	2M/6ftx16mm
30 20 03 07	3M/10ftx16mm
30 20 03 08	3.5M/12ftx16mm
30 20 03 09	5M/16ftx19mm
30 20 03 10	5M/16ftx25mm
30 20 03 11	5.5M/18ftx25mm
30 20 03 12	7.5M/25ftx25mm
30 20 03 13	7.5M/25ftx32mm
30 20 03 14	8M/27ftx25mm
30 20 03 15	8M/27ftx32mm
30 20 03 16	10M/33ftx25mm
30 20 03 17	10M/32ftx32mm



DOUBLE COLOR MEASURING TAPE



Item no.	Contents
30 20 03 18	2M/6ftx16mm
30 20 03 19	3M/10ftx16mm
30 20 03 20	3.5M/12ftx19mm
30 20 03 21	5M/16ftx19mm
30 20 03 22	5M/16ftx25mm
30 20 03 23	5.5M/18ftx19mm
30 20 03 24	5.5M/18ftx25mm
30 20 03 25	7.5M/25ftx25mm
30 20 03 26	8M/27ftx25mm

ABS MEASURING TAPE

- ▶ Double color
- ▶ 2 stops
- ▶ With two magnet on hook



Item no.	Contents
30 20 03 37	3M/10ftx16mm
30 20 03 38	3.5M/12ftx16mm
30 20 03 39	5M/16ftx19mm
30 20 03 40	5M/16ftx25mm
30 20 03 41	7.5M/25ftx25mm
30 20 03 42	8M/27ftx25mm
30 20 03 43	10M/33ftx25mm

MEASURING TAPE

- ▶ Ergonomically designed case for comfortable grip
- ▶ Chrome plated ABS case with rubber coated
- ▶ Self-locking mechanism



Item no.	Contents
30 20 03 56	2M/6ftx16mm
30 20 03 57	3M/10ftx16mm
30 20 03 58	3.5M/12ftx16mm
30 20 03 59	5M/16ftx19mm
30 20 03 60	5.5M/18ftx25mm
30 20 03 61	7.5M/25ftx25mm
30 20 03 62	8M/26ftx25mm

MEASURING TAPE

- ▶ ABS case, with blade locking button and belt clip.
- ▶ Moveable hook, accurate for internal and external measurement



Item no.	Contents
30 20 03 27	3M/10ftx12.5mm
30 20 03 28	3M/10ftx16mm
30 20 03 29	5M/16ftx19mm
30 20 03 30	5M/16ftx25mm
30 20 03 31	7.5M/25ftx25mm
30 20 03 32	10M/32ftx25mm

LONG STEEL MEASURING TAPE

- ▶ With locking handle.
- ▶ Take back the blade with 3 times speed



Item no.	Contents
30 20 03 44	10M/33ftx13mm
30 20 03 45	15M/49ftx13mm
30 20 03 46	20M/66ftx13mm
30 20 03 47	30M/99ftx13mm
30 20 03 48	50M/164ftx13mm

MEASURING TAPE

- ▶ Ergonomically designed case for comfortable grip
- ▶ ABS case with rubber coated
- ▶ Self-locking mechanism



Item no.	Contents
30 20 03 63	2M/6ftx16mm
30 20 03 64	3M/10ftx16mm
30 20 03 65	3.5M/12ftx16mm
30 20 03 66	5M/16ftx19mm
30 20 03 67	5.5M/18ftx25mm
30 20 03 68	7.5M/25ftx25mm
30 20 03 69	8M/26ftx25mm
30 20 03 70	10M/33ftx25mm

MEASURING TAPE

- ▶ ABS case, with locking button and belt clip.
- ▶ Self-locking mechanism



Item no.	Contents
30 20 03 33	2M/6ftx16mm
30 20 03 34	3M/10ftx16mm
30 20 03 35	5M/16ftx19mm
30 20 03 36	7.5M/25ftx25mm

MEASURING TAPE

- ▶ Ergonomically designed case for comfortable grip
- ▶ Color painted ABS case with rubber coated
- ▶ Self-locking mechanism



Item no.	Contents
30 20 03 49	2M/6ftx16mm
30 20 03 50	3M/10ftx16mm
30 20 03 51	3.5M/12ftx16mm
30 20 03 52	5M/16ftx19mm
30 20 03 53	5.5M/18ftx25mm
30 20 03 54	7.5M/25ftx25mm
30 20 03 55	8M/26ftx25mm

FIBERGLASS TAPES

- ▶ Ideal for contractors and surveyors
- ▶ Design allow easy cleaning of tape
- ▶ Long winder with easy grip knob facilities quick Rewinding
- ▶ Heavy duty ABS case
- ▶ Protruding marker at the bottom of the case allows easy measurement of land
- ▶ Tapes are safe from electrical hazards



Item no.	Contents
30 20 30 01	30Mx13mm



FIBERGLASS TAPES

- ▶ Fiberglass tape, ABS plastic case with a plated flush winding handle and stainless steel holding claw on the end of tape.



Item no.	Contents
30 20 30 02	10M
30 20 30 03	20M
30 20 30 04	30M
30 20 30 05	50M

LONG STEEL MEASURING TAPE

- ▶ High impact ABS case fits comfortably in hand
- ▶ High carbon steel blade coated with acrylic polymers for long life time use
- ▶ Ideal for high precision professional jobs
- ▶ Easy to read bold black numbers on 10mm(5/8")/13mm(1/2") wide yellow or white blade



Item no.	Contents
30 20 30 15	10M/33ft
30 20 30 16	15M/50ft
30 20 30 17	20M/66ft
30 20 30 18	30M/100ft
30 20 30 19	50M/165ft

OPEN REEL FIBER MEASURING TAPE

- ▶ High impact ABS case fits comfortably in hand
- ▶ Ideal for high precision professional jobs
- ▶ Easy to read bold black numbers on 10mm(5/8")/13mm(1/2") wide yellow or white blade



Item no.	Contents
30 20 40 07	20M/66ft
30 20 40 08	30M/83ft
30 20 40 09	50M/165ft

FIBERGLASS TAPES

- ▶ Co-molded rubber case for comfortable grip and durability



Item no.	Contents
30 20 30 06	10M/33ft
30 20 30 07	20M/66ftx13mm
30 20 30 08	30M/100ftx13mm
30 20 30 09	50M/165ftx13mm

LONG STEEL MEASURING TAPE

- ▶ Co-molded rubber case, high carbon steel blade coated with acrylic polymers for long life, ideal for high precision professional jobs, easy to read bold black numbers on 10mm/13mm wide yellow or white blade



Item no.	Contents
30 20 30 20	15M/50ft
30 20 30 21	20M/66ft
30 20 30 22	30M/100ft
30 20 30 23	50M/165ft

OPEN REEL STEEL MEASURING TAPE

- ▶ High impact ABS case fits comfortably in hand
- ▶ High carbon steel blade coated with acrylic polymers for long life time use
- ▶ Ideal for high precision professional jobs
- ▶ Easy to read bold black numbers on 10mm(5/8")/13mm(1/2") wide yellow or white blade



Item no.	Contents
30 20 40 11	20M/66ft
30 20 40 12	30M/100ft
30 20 40 13	50M/165ft

FIBER MEASURING TAPE

- ▶ Co-molded rubber case for comfortable grip and durability



Item no.	Contents
30 20 30 10	10M/33ft
30 20 30 11	15M/50ft
30 20 30 12	20M/66ft
30 20 30 13	30M/100ft
30 20 30 14	50M/165ft

OPEN REEL FIBER MEASURING TAPE

- ▶ Superior quality fiberglass material, one-step process of 2 symmetrical, zero points of metric/imperial blade



Item no.	Contents
30 20 40 01	20M/66'x13mm
30 20 40 02	25M/83'x13mm
30 20 40 03	30M/100'x13mm
30 20 40 04	50M/165'x13mm
30 20 40 05	75M/248'x13mm
30 20 40 06	100M/330'x13mm

OPEN REEL STEEL MEASURING TAPE



Item no.	Contents
30 20 40 14	5M
30 20 40 15	10M
30 20 40 16	20M
30 20 40 17	30M
30 20 40 18	50M



GIFT TAPE



Item no.	Contents
30 20 02 77	

STAINLESS STEEL RULE

- ▶ Precision ruler manufactured from hardened steel
- ▶ The graduations are permanently etched into the ruler surface and painted black



Item no.	Contents
30 40 00 01	150mmx18mm
30 40 00 02	200mmx18mm
30 40 00 03	300mmx18mm
30 40 00 04	500mmx30mm
30 40 00 05	1000mmx32mm
30 40 00 06	1200mmx35mm
30 40 00 07	1500mmx38mm
30 40 00 08	2000mmx40mm

ALUMINUM STRAIG

- ▶ Precision ruler manufactured from aluminum
- ▶ The graduations are permanently etched into the ruler surface and painted black



Item no.	Contents
30 40 00 09	300mmx50mm
30 40 00 10	500mmx50mm
30 40 00 11	600mmx50mm
30 40 00 12	800mmx50mm
30 40 00 13	1000mmx50mm

SQUARE RULER

- ▶ With metal stock in yellow lacquered,mm/inch sizes printing



Item no.	Contents
30 50 00 01	6"/150mm
30 50 00 02	8"/200mm
30 50 00 03	10"/250mm
30 50 00 04	12"/300mm
30 50 00 05	14"/350mm
30 50 00 06	16"/400mm

SQUARE RULER

- ▶ Hardened steel, black matter finishing



Item no.	Contents
30 50 00 07	600mmx400mm
30 50 00 08	300mmx200mm

PROFESSIONAL SQUARE RULER

- ▶ Hardened Polished Steel, with punched sizes



Item no.	Contents
30 50 00 09	600mmx400mm
30 50 00 10	300mmx200mm

TRY AND MITRE SQUARES

- ▶ Stainless steel blade and heavy cast aluminium base.
- ▶ The clear black graduations are permanently etched for long services.



Item no.	Contents
30 50 00 11	

TRY AND MITRE SQUARES

- ▶ Both blade and base are made of Aluminum alloy
- ▶ Graduations etched and painted black



Item no.	Contents
30 50 00 12	

COMBINATION JOINER TRY SQUARE

- ▶ Each blade has permanently etched black painted markings
- ▶ Combination squares are available in 3 finishes
- ▶ 1)Zinc alloy base with stainless steel blade
- ▶ 2)Zinc alloy base with steel blade
- ▶ 3)Plastic base with steel blade



Item no.	Contents
30 50 00 13	

COMBINATION JOINER TRY SQUARE

- ▶ Cast metal stock, milled faces, brass screws and scriber with built in spirit level
- ▶ Stainless steel ruler graduated metric and imperial measurement with 180°protractor and centre head



Item no.	Contents
30 50 00 14	

SLIDING BEVEL RULER



Item no.	Contents
30 50 00 15	

ANGLE GAGE



Item no.	Contents
30 50 00 16	

ANGLE GAGE



Item no.	Contents
30 50 00 17	

CALIPER



Item no.	Contents
30 50 00 18	

FEELER GAUGES

▶ Nickel plated case with 13 conical, polished blades



Item no.	Contents
30 50 00 19	

ALUMINUM ALLOY ANGLE SQUARE

▶ With precision bubble on the handle.



Item no.	Contents
30 50 01 05	150mm
30 50 01 06	250mm

FEELER RULER

▶ Wooden execution with spring



Item no.	Contents
30 40 30 01	1M
30 40 30 02	2M

FEELER GAUGES

▶ Nickel plated case with 20 conical, polished blades



Item no.	Contents
30 50 00 20	

ANGLE SQUARE WITH PLASTIC HANDLE

▶ With stainless steel blade and plastic handle.
▶ Include a vertical bubble on the handle.



Item no.	Contents
30 50 01 07	8"

FEELER RULER

▶ Plastic execution with spring



Item no.	Contents
30 40 30 03	1M
30 40 30 04	2M

T-TYPE SQUARE RULER

▶ Material is Aluminum alloy
▶ Yellow painted/Oxidation
▶ Thickness is 3mm/5mm



Item no.	Contents
30 50 01 01	48"
30 50 01 02	54"

ANGLE SQUARE WITH WOODEN HANDLE

▶ With stainless steel blade and wooden handle.



Item no.	Contents
30 50 01 08	8"

MINI FOLDING RULER

▶ 10 sections, 0.5m per section
▶ ABS material with spring.



Item no.	Contents
30 40 30 05	1M

YELLOW PAINT STAINLESS STEEL STRAIGHTEDGE RULER

▶ Material is stainless steel
▶ With big wooden handle.



Item no.	Contents
30 50 01 03	750mm

ELECTRIC CIRCULAR SAW GAGE

▶ Hardened steel, black paint finish



Item no.	Contents
30 50 01 09	300mm

ALUMINUM ALLOY ROOFING SQUARE



Item no.	Contents
30 50 30 01	180mm

SCALE

▶ Material is Aluminum alloy



Item no.	Contents
30 50 01 04	300mm

SCALE RULER

▶ Material of it is PC
▶ With 6 sections, different scaling.



Item no.	Contents
30 50 01 10	

ALUMINUM ALLOY ROOFING SQUARE



Item no.	Contents
30 50 30 02	180mm





OUTSIDE CALIPER

- ▶ Carbon steel
- ▶ polished

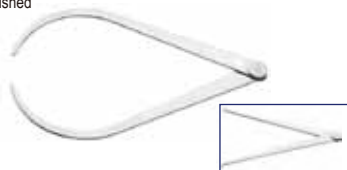

Item no.	Contents
30 99 00 01	outside caliper
30 99 00 02	inside caliper

OUTSIDE CALIPER

- ▶ Carbon steel
- ▶ polished



Item no.	Contents
30 99 00 03	outside caliper
30 99 00 04	inside caliper

WING COMPASS

- ▶ Carbon steel
- ▶ polished



Item no.	Contents
30 99 00 05	

DIVIDER COMPASS

- ▶ Carbon steel
- ▶ polished



Item no.	Contents
30 99 00 06	

DIAL INDICATORS

- ▶ Absolute gear-driven system
- ▶ High precision
- ▶ Jeweled and shock-proof
- ▶ Dustproof cap



Item no.	Contents
30 30 30 01	

PRECISION VERNIER CALIPERS

- ▶ Carbon steel
- ▶ Chrome-plated
- ▶ Four-way measurement: internal, External, depth and step.
- ▶ Reading 0.02mm; In wooden/plastic case.



Item no.	Contents
30 30 00 01	150mm

PRECISION VERNIER CALIPERS

- ▶ Carbon steel
- ▶ Chrome-plated
- ▶ Four-way measurement: internal, External, depth and step
- ▶ With thumb block, Reading 0.05mm; In wooden/plastic case.



Item no.	Contents
30 30 00 02	150mm

DIAL PRECISION VERNIER CALIPERS

- ▶ Carbon steel
- ▶ Chrome-plated, slider displacements are amplified by a rack and pinion mechanism and indicated on the dial
- ▶ Four-way measurement: internal, External, depth and step, with thumbblock, Reading 0.02mm
- ▶ In wooden/plastic case.



Item no.	Contents
30 30 00 03	150mm

DIGITAL DISPLAY PRECISION VERNIER CALIPERS

- ▶ Made of hardened steel
- ▶ Digital function include: Metric/ Inch ;
- ▶ Zero reset;
- ▶ Graduations: 0.01mm/0.0005;
- ▶ Four-way measurement: internal, External, depth and step!
- ▶ Supplied 2 SR44 batteries - one integral and one spare
- ▶ In wooden/plastic case



Item no.	Contents
30 30 00 04	150mm

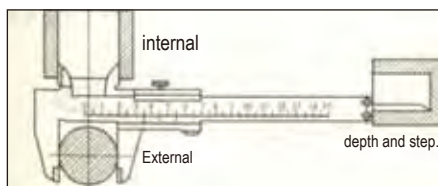

PRECISION VERNIER CALIPERS

- ▶ Chrome plated finished
- ▶ Thumb control and locking screw
- ▶ 0-100mm



Item no.	Contents
30 30 00 05	150mm

PRECISION CALIPERS

- ▶ Inside, outside, step and depth measurements are made with the smooth moving slide.
- ▶ Includes metric scale and SAE scale graduated in millimeters and 16ths.



Item no.	Contents
30 30 00 06	150mm

OUTSIDE MICROMETER



Item no.	Contents
30 30 30 02	0-50mm
30 30 30 03	25-50mm
30 30 30 04	50-75mm
30 30 30 05	75-100mm

ELECTRIC DIGITAL OUTSIDE MICROMETER

- ▶ Hardened Steel, with 7 buttons for Metric/Inch conversion, Data hold, Relative/Absolute measuring, Tolerance Setting, Positive setting, Negative Setting, Origin Output



Item no.	Contents
30 30 30 06	0-50mm
30 30 30 07	25-50mm
30 30 30 08	50-75mm
30 30 30 09	75-100mm

PRECISION DEPTH VERNIER CALIPER

- ▶ Stainless steel with changeable needle



Item no.	Contents
30 30 00 07	0-80mm
30 30 00 08	0-200mm
30 30 00 09	0-300mm

ELECTRONIC DIGITAL DEPTH GAUGE

- ▶ Stainless steel body
- ▶ LED display



Item no.	Contents
30 30 00 10	0-150mm
30 30 00 11	0-200mm
30 30 00 12	0-300mm
30 30 00 13	0-500mm

HEIGHT VERNIER CALIPER

- ▶ Range/mm:0-200/0-300/0-500
- ▶ Reading/mm:0.02/0.05



Item no.	Contents
30 30 00 14	

DIGITAL HEIGHT GAUGE

- ▶ Range/mm:0-300/0-500/0-600/0-800/0-1000/0-1500/0-2000
- ▶ Reading/mm:0.01
- ▶ feature:manual power on/off
- ▶ Zero setting at any position
- ▶ Metric/Inch system interchange at any position
- ▶ With data output interface
- ▶ With display predetermination function
- ▶ With hard alloy tipped scriber,it's easy for scribing



Item no.	Contents
30 30 00 15	

MAGNETIC STAND

- ▶ The products are widely used in machine processing.
- ▶ Parts measuring, equipment correcting,
- ▶ For its reasonable structure, novel and portable features
- ▶ With dial indicator



Item no.	Contents
30 99 00 07	

6PCS.PRECISION MEASURING TOOL SET

- ▶ 0-150mm caliper
- ▶ 0-25mm out side micrometer
- ▶ 100X63 precision knife edge square 90°;
- ▶ 100mm straight edges
- ▶ 150mm flex scale;
- ▶ 125mm marking device



Item no.	Contents
30 99 00 07	

4PCS.PRECISION MEASURING TOOL SET

- ▶ 0-150mm caliper
- ▶ 0-25mm out micrometer
- ▶ 100X63 precision knife edge square 90°;
- ▶ 150mm ruler



Item no.	Contents
30 99 00 07	

PLASTIC SPIRIT LEVEL

- ▶ All plastic level
- ▶ With three bubbles: a vertical bubble, a horizontal bubble, and a 45 degree bubble



Item no.	Contents
30 10 30 01	300MM
30 10 30 02	400MM
30 10 30 03	500MM
30 10 30 04	600MM
30 10 30 05	800MM
30 10 30 06	1000MM
30 10 30 07	1200MM
30 10 30 08	1500MM

ALUMINIUM SPIRIT LEVEL

- ▶ Straight-edge made of aluminium profile
- ▶ With four bubbles: two vertical bubbles, a horizontal bubble, and another horizontal bubble on top



Item no.	Contents
30 10 30 09	300MM
30 10 30 10	400MM
30 10 30 11	500MM
30 10 30 12	600MM
30 10 30 13	800MM
30 10 30 14	1000MM
30 10 30 15	1200MM
30 10 30 16	1500MM

ALUMINIUM SPIRIT LEVEL

- ▶ Aluminum body
- ▶ With three bubbles: a vertical bubble, a horizontal bubble, a 45 degree bubble



Item no.	Contents
30 10 30 17	300MM
30 10 30 18	400MM
30 10 30 19	500MM
30 10 30 20	600MM
30 10 30 21	800MM
30 10 30 22	1000MM
30 10 30 23	1200MM
30 10 30 24	1500MM

ALUMINIUM SPIRIT LEVEL

- ▶ NO VIAL
- ▶ BOX SECTION



Item no.	Contents
30 10 00 01	1M
30 10 00 02	1.5M
30 10 00 03	2M
30 10 00 04	2.5M
30 10 00 05	3M



ALUMINIUM SPIRIT LEVEL

- ▶ NO VIAL
- ▶ BOX SECTION



Item no.	Contents
30 10 00 06	1M
30 10 00 07	1.5M
30 10 00 08	2M
30 10 00 09	2.5M
30 10 00 10	3M

SPIRIT LEVEL

- ▶ Aluminum body
- ▶ With two bubbles: a vertical bubble, a horizontal bubble



Item no.	Contents
30 10 00 11	300MM
30 10 00 12	400MM
30 10 00 13	500MM
30 10 00 14	600MM
30 10 00 15	800MM
30 10 00 16	1000MM
30 10 00 17	1200MM

SPIRIT LEVEL

- ▶ Aluminum body
- ▶ With two bubbles: a vertical bubble, a horizontal bubble
- ▶ Milled bottom for high accuracy



Item no.	Contents
30 10 00 18	300MM
30 10 00 19	400MM
30 10 00 20	500MM
30 10 00 21	600MM
30 10 00 22	800MM
30 10 00 23	1000MM
30 10 00 24	1200MM

SPIRIT LEVEL

- ▶ Aluminum box section level, with horizontal and vertical vials set in magnifying flexiglass.
- ▶ Accuracy 1mm per 1m =0.057°
- ▶ Hanging tabs for user's convenience.



Item no.	Contents
30 10 30 26	300MM
30 10 30 27	400MM
30 10 30 28	500MM
30 10 30 29	600MM
30 10 30 30	800MM
30 10 30 31	1000MM
30 10 30 32	1200MM

SPIRIT LEVEL(WITH ANGLE FINDER)

- ▶ Aluminum box section level, with horizontal, vertical and angle finder vials,
- ▶ Allows the users reading any angles from 0° to 90°;
- ▶ Accuracy 1mm per 1m =0.057°;
- ▶ Hanging hole for user's convenience.



Item no.	Contents
30 10 30 33	300MM
30 10 30 34	400MM
30 10 30 35	500MM
30 10 30 36	600MM
30 10 30 37	800MM
30 10 30 38	1000MM
30 10 30 39	1200MM

SPIRIT LEVEL

- ▶ Heavy duty box level
- ▶ Professional and accuracy
- ▶ "M" aluminum profile improve strength of level
- ▶ Milled surface for high accuracy
- ▶ "V" grooved base for work on all kinds of pipes



Item no.	Contents
30 10 30 40	300MM
30 10 30 41	400MM
30 10 30 42	500MM
30 10 30 43	600MM
30 10 30 44	800MM
30 10 30 45	1000MM
30 10 30 46	1200MM

SPIRIT LEVEL

- ▶ Heavy duty ribbed level with horizontal, vertical and 45° vials
- ▶ Include top and bottom milled working faces use both in normal position and when inverted;
- ▶ Accuracy 1mm per 1m =0.057°



Item no.	Contents
30 10 30 47	300MM
30 10 30 48	400MM
30 10 30 49	500MM
30 10 30 50	600MM
30 10 30 51	800MM
30 10 30 52	1000MM
30 10 30 53	1200MM



SPIRIT LEVEL

- ▶ Heavy duty Aluminum frame,
- ▶ Powder coated surface
- ▶ With three bubbles: two vertical bubbles, and a horizontal bubble
- ▶ Include top and bottom milled working faces use both in normal position and when inverted
- ▶ Rubber end caps for Anti-shock when dropping



Item no.	Contents
30 10 30 54	600MM
30 10 30 55	800MM
30 10 30 56	1000MM
30 10 30 57	1200MM
30 10 30 58	1500MM
30 10 30 59	2000MM

SPIRIT LEVEL

- ▶ Heavy duty Aluminum frame,
- ▶ Electronic plated surface
- ▶ With three bubbles: two vertical bubbles, and a horizontal bubble
- ▶ Include top and bottom milled working faces use both in normal position and when inverted
- ▶ Rubber end caps for Anti-shock when dropping



Item no.	Contents
30 10 30 60	600MM
30 10 30 61	800MM
30 10 30 62	1000MM
30 10 30 63	1200MM
30 10 30 64	1500MM
30 10 30 65	2000MM

SPIRIT LEVEL

- ▶ Heavy duty Aluminum frame,
- ▶ Electronic plated surface
- ▶ With three bubbles: two vertical bubbles, and a horizontal bubble
- ▶ Include top and bottom milled working faces use both in normal position and when inverted
- ▶ Rubber end caps for Anti-shock when dropping



Item no.	Contents
30 10 30 66	300MM
30 10 30 67	400MM
30 10 30 68	500MM
30 10 30 69	600MM
30 10 30 70	800MM
30 10 30 71	1000MM
30 10 30 72	1200MM

ALUMINIUM SPIRIT LEVEL

- ▶ Heavy duty Aluminum frame,
- ▶ Electronic plated surface
- ▶ With three bubbles: two vertical bubbles, and a horizontal bubble
- ▶ Include top and bottom milled working faces use both in normal position and when inverted
- ▶ Rubber end caps for Anti-shock when dropping



Item no.	Contents
30 10 30 73	600MM
30 10 30 74	800MM
30 10 30 75	1000MM
30 10 30 76	1200MM
30 10 30 77	1500MM
30 10 30 78	2000MM

ALUMINIUM SPIRIT LEVEL

- ▶ Heavy duty Aluminum frame,
- ▶ With three bubbles: two vertical bubbles, and a horizontal bubble
- ▶ Include top and bottom milled working faces use both in normal position and when inverted
- ▶ With v-groove bottom for pipes
- ▶ Inset magnets
- ▶ Rubber end caps for Anti-shock when dropping



Item no.	Contents
30 10 30 79	600MM
30 10 30 80	800MM
30 10 30 81	1000MM
30 10 30 82	1200MM
30 10 30 83	1500MM
30 10 30 84	2000MM

ALUMINIUM SPIRIT LEVEL

- ▶ Aluminum body
- ▶ With three bubbles: two vertical bubbles, a horizontal bubble
- ▶ With unique expandable system, designed for carrying in a tool box, and expand when the situation requires
- ▶ Ruled edge
- ▶ Curved edge for pipes
- ▶ Rubber end caps for Anti-shock when dropping



Item no.	Contents
30 10 30 85	600-900MM
30 10 30 86	900-1200MM

ALUMINIUM SPIRIT LEVEL

- ▶ V-Shape slot for measuring objects with round surface
- ▶ Handle covered with rubber offers greater comforter
- ▶ Cylindrical magnified vials gives a clear view
- ▶ Finely milled base
- ▶ Vials with different slope, 1.5:100 and 3.5:100, suitable for plumbing works under different circumstance



Item no.	Contents
30 10 30 87	

ALUMINIUM SPIRIT LEVEL

- ▶ V-Shape slot for measuring objects with round surface
- ▶ Handle covered with rubber offers greater comforter
- ▶ Cylindrical magnified vials gives a clear view
- ▶ Vials with different slope, 1.5:100 and 3.5:100, suitable for plumbing works under different circumstance



Item no.	Contents
30 10 30 88	

MULTI-FUNCTION SPIRIT LEVEL

- ▶ Heavy duty aluminum profile, with line level and torpedo level ; Line level can be used on the rope. Torpedo level can also be used separately; V grooved bottom for working on all kinds of pipes.



Item no.	Contents
30 10 30 89	600MM

MULTI-FUNCTION SPIRIT LEVEL

- ▶ Contents: 2 line makers on level with transparent, which can be used with level Pencil box 15 cm steel ruler on the level, which can use for angle measurement 1 m measuring tape



Item no.	Contents
30 10 30 90	600MM
30 10 30 90	800MM
30 10 30 92	1000MM

SPIRIT LEVEL RULER

- ▶ Heavy duty aluminum profile with certain size of drill holes, ruler, movable marker, nails. 2 movable marker can be used to a line two horizontal vertical and measure it's distance.



Item no.	Contents
30 10 30 93	660mm

TORPEDO LEVEL

- ▶ Plastic body
- ▶ With three bubbles: a vertical bubble, a horizontal bubble, and a 45 degree bubble



Item no.	Contents
30 10 60 01	9"

TORPEDO LEVEL

- ▶ Plastic body
- ▶ With three bubbles: a vertical bubble, a horizontal bubble, and a 45 degree bubble



Item no.	Contents
30 10 60 02	9"

TORPEDO LEVEL

- ▶ Aluminum frame
- ▶ With three bubbles: a vertical bubble, a horizontal bubble, and a 45 degree bubble
- ▶ With top view window



Item no.	Contents
30 10 60 03	9"

TORPEDO LEVEL

- ▶ Aluminum frame
- ▶ With three bubbles: a vertical bubble, a horizontal bubble, and a 45 degree bubble



Item no.	Contents
30 10 60 04	

CAST SPIRIT LEVEL

- ▶ Heavy duty cast aluminum trapezoid shaped level. Milled base; Fixed all-round impact resistant horizontal and plumb vials. Hang hole



Item no.	Contents
30 10 60 05	400MM
30 10 60 06	500MM
30 10 60 07	600MM

CAST SPIRIT LEVEL

- ▶ Heavy duty cast aluminum trapezoid shaped level. Milled base; Fixed all-round impact resistant horizontal and plumb vials. Hang hole



Item no.	Contents
30 10 60 08	400MM
30 10 60 09	500MM
30 10 60 10	600MM



ALUMINIUM LEVEL

- ▶ With three bubbles: one vertical bubble, one horizontal bubble and one adjustable vial.
- ▶ Double milled surface for high accuracy.
- ▶ Rubber handles and end caps for anti-shock when dropping.



Item no. Contents

30 10 40 01	600MM
30 10 40 02	800MM
30 10 40 03	1000MM
30 10 40 04	1200MM
30 10 40 05	1500MM

ALUMINIUM LEVEL

- ▶ With three bubbles and top view window.
- ▶ Double milled surface for high accuracy.
- ▶ Rubber end caps for anti-shock when dropping.



Item no. Contents

30 10 40 06	400MM
30 10 40 07	500MM
30 10 40 08	600MM
30 10 40 09	800MM
30 10 40 10	1000MM
30 10 40 11	1200MM
30 10 40 12	1500MM

BRIDGE SPIRIT LEVEL

- ▶ Heavy duty aluminum with powder coated surface.
- ▶ With two vials: one is vertical bubble and another is horizontal bubble.



Item no. Contents

30 10 40 13	400MM
30 10 40 14	500MM
30 10 40 15	600MM

BRIDGE SPIRIT LEVEL

- ▶ Aluminum body with powder coated surface.
- ▶ With three vials and milled base



Item no. Contents

30 10 40 16	250MM
-------------	-------

SPIRIT LEVEL

- ▶ Plastic body with three bubbles: one is horizontal bubble and two vertical bubbles.
- ▶ Double milled surface for high accuracy.



Item no. Contents

30 10 40 17	400MM
30 10 40 18	500MM
30 10 40 19	600MM
30 10 40 20	800MM
30 10 40 21	1000MM
30 10 40 22	1200MM

SPIRIT LEVEL

- ▶ Frame structure.
- ▶ Powder coated surface.
- ▶ With three different degree bubbles, and six surfaces milled.



Item no. Contents

30 10 40 23	400MM
30 10 40 24	500MM
30 10 40 25	600MM
30 10 40 26	700MM

BRIDGE SPIRIT LEVEL

- ▶ Aluminum body, with heavy duty frame,.
- ▶ With three different degree bubbles, and three surfaces milled.



Item no. Contents

30 10 40 27	400MM
30 10 40 28	600MM
30 10 40 29	800MM
30 10 40 30	1000MM

SCRAPER

- ▶ Aluminum body, with two handle



Item no. Contents

30 10 40 31	1.2M
30 10 40 32	1.5M
30 10 40 33	1.8M
30 10 40 34	2M

SCRAPER

- ▶ Aluminum body, with two handle



Item no. Contents

30 10 40 35	1M
30 10 40 36	1.5M
30 10 40 37	2M
30 10 40 38	2.5M
30 10 40 39	3M

SCRAPER

- ▶ Heavy duty Aluminum frame, powder coated surface.
- ▶ With three different degree bubbles.
- ▶ Double milled surface for high accuracy.
- ▶ Rubber handles and end caps for anti-shock when dropping.



Item no. Contents

30 10 40 40	600MM
30 10 40 41	800MM
30 10 40 42	1000MM
30 10 40 43	1200MM
30 10 40 44	1500MM
30 10 40 45	2000MM

GIFT SPIRIT LEVEL



Item no.	Contents
30 80 00 01	

MINI LASER LEVEL WITH SCREWDRIVER

- ▶ Constructed of heavy duty aluminum, this laser works in conjunction with a built-in bubble level for perfect alignment
- ▶ Magnetic bit holder for three screwdriver bits



Item no.	Contents
30 15 60 01	

LASER SPIRIT LEVEL KIT

- ▶ Laser level 400mm with GS/CE-Approval, measuring range 30 m, class laser: Rotary base with scale; 90° deflector, line projector; Aluminum sturdy tripod with ascended central column; In carrying blow case



Item no.	Contents
30 90 00 03	

ACCESSORIES OF SPIRIT LEVEL

- ▶ With one bubble



Item no.	Contents
30 80 00 02	

DIGITAL ANGLE FINDER

- ▶ Large LCD display for easy read-out
- ▶ Digital angle measurement from 0° to 360°
- ▶ For fast and easy angle measurement



Item no.	Contents
30 99 00 08	

SELF-ADJUSTING LASER

- ▶ Accuracy of vials: 0.5mm/m
- ▶ Laser output power: < 1mw
- ▶ visible red light $\lambda=635nm$
- ▶ Laser Class : II ; Protection Class: III
- ▶ Power: 4 X AA battery; Packing in Gift color box.
- ▶ Project horizontal, vertical and crossed lasers, see pictures 1,2,3.
- ▶ Beeping when the laser is shaking (use it only when the lasers are stable).
- ▶ Rubber cover for comfortable handle.
- ▶ ON/OFF button with loose/lock function.
- ▶ Stainless metal surface for easy cleaning.



Item no.	Contents
30 90 00 03	

ACCESSORIES OF SPIRIT LEVEL

- ▶ With two bubbles: vertical and horizontal



Item no.	Contents
30 80 00 03	

DIGITAL ANGLE FINDER

- ▶ LCD screen display; Low Bat; Thickness: 1.8mm; Accuracy: 0.5mm/m
- ▶ Measuring any angle in various position
- ▶ Can be measured in headstand position
- ▶ Resolution: 0.1degree. ▶ 9V battery powered.
- ▶ Bottoms milled. ▶ Professional Market.
- ▶ TUV/GS/CE Approval



Item no.	Contents
30 99 00 09	

DIGITAL LEVEL

- ▶ Professional quality; Digital function for easy reading and checking; Laser function for vertical, horizontal, cross, dot.



Item no.	Contents
30 10 00 25	

ACCESSORIES OF SPIRIT LEVEL

- ▶ With one round bubble



Item no.	Contents
30 80 00 04	

PLASTIC LASER LEVEL

- ▶ The adjustable nut can make the level work in the topside area



Item no.	Contents
30 15 60 02	

ROTARY LASER LEVEL

- ▶ Rotary laser level use 4xAA batteries;
- ▶ Aluminum sturdy tripod with ascended central column;
- ▶ In carrying blow case.



Item no.	Contents
30 15 30 01	

ACCESSORIES OF SPIRIT LEVEL

- ▶ With three bubbles



Item no.	Contents
30 80 00 05	

MINI LASER LEVEL

- ▶ Light Aluminum body with two vials, the multi-purpose switch for point and line using, the level can be adjusted after fixing on the small tripod, easy to take, packed in double blister card with two AAA batteries.



Item no.	Contents
30 15 60 03	

ROTARY LASER LEVEL

- ▶ Rotary laser level use 4xAA batteries;
- ▶ Aluminum sturdy tripod with ascended central column;
- ▶ In carrying blow case.



Item no.	Contents
30 15 30 02	

LASER LEVEL

- ▶ Working range up to 6 Meters
- ▶ Recommended Use Indoors
- ▶ Laser output power < 1mw ; Visible red light λ = 650 nm
- ▶ Protection Class II; Degree of protection. Ordinary.
- ▶ 3 AA BATTERIES; FUNCTION: LASER STRAIGHT LINE
- ▶ 4pcs/inner carton, size: 35*23*23cm;
- ▶ 24pcs/outer carton, size: 71.5*36*48.5cm.



Item no.	Contents
30 15 30 06	

SELF LEVELING LASER

- ▶ Vertical and horizontal accuracy: 1.5mm/5m
- ▶ Accuracy of the cross line: 1.5mm/5m
- ▶ Accuracy of the point down: 2mm/m
- ▶ The width of laser line in the position of 5m: 2.5mm
- ▶ Wavelength of the laser: 635nm
- ▶ Output 1mw
- ▶ Leveling scope: 3°
- ▶ Self leveling time < 5s
- ▶ The angle of laser range: 110°
- ▶ Working range: 10m
- ▶ The best operating radius: 2~5m
- ▶ Power supply: 4x1.5V(AA)batteris
- ▶ Working temperature: -5 C ~ 40 C



Item no.	Contents
30 15 30 07	

THERE LASER LINE GENERATOR

- ▶ Accuracy: 1mm/m
- ▶ Laser power: < 5mw, < 1mw
- ▶ Wavelength: 650nm, 635nm
- ▶ Power supply: 2XLR6 batteries

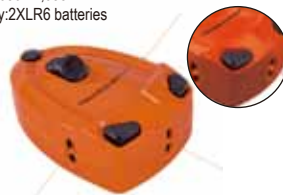

Item no.	Contents
30 15 30 09	

LASER LINE GENERATOR(MOUSE SHAPED)

- ▶ Accuracy: 2mm/m
- ▶ Laser power: < 5mw, < 1mw
- ▶ Wavelength: 650nm, 635nm
- ▶ Power supply: 2XLR6 batteries



Item no.	Contents
30 15 30 10	

ANGLE FINDER

- ▶ Measuring angle between 0°-185°, accuracy 1°
- ▶ GS/CE/FDA approved



Item no.	Contents
30 99 00 13	

AUTO-LEVELING LASER TOOL

- ▶ Give off horizontal/vertical laser line to check/ correct the horizontal/vertical status of target object
- ▶ Oblique incidence made by vertical laser line can also irradiate to wall and roof
- ▶ Use the auto-setting device without any adjustment
- ▶ Make 360° rotation on the horizontal direction
- ▶ Hang this level on any height with the stationary rings



Item no.	Contents
30 15 30 03	

SELF-ADJUSTING LASER

- ▶ Rotary laser level use 3xAA batteries
- ▶ Self-adjustable
- ▶ Horizontal, vertical and cross line
- ▶ Aluminum sturdy tripod with ascended central column
- ▶ In carrying blow case



Item no.	Contents
30 15 30 04	

ROTARY LASER LEVEL

- ▶ Rotary laser level use 3xAA batteries
- ▶ Horizontal and vertical rotary plane or dot
- ▶ Aluminum sturdy tripod with ascended central column
- ▶ Including a torpedo level, a 5M tape measure, a line level, a chalk line, a bottle of powder, a knife
- ▶ In carrying blow case



Item no.	Contents
30 15 30 05	

ROTARY LASER LEVEL



Item no.	Contents
30 70 20 01	

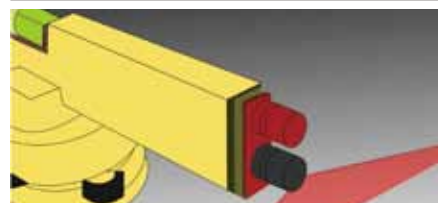

MEASURING WHEEL



Item no.	Contents
30 99 00 07	Φ10.0cm
30 99 00 08	Φ15.8cm
30 99 00 09	Φ20.0cm

SPRING SCALE

- ▶ Travel spring balance fishing scale, hanging scale, spring scale



Item no.	Contents
30 60 00 06	0-12.5kg
30 60 00 07	0-25kg
30 60 00 08	0-50kg
30 60 00 09	0-100kg

SPRING POCKET BALANCE

- ▶ Including a measuring tape of 1 m long
- ▶ Weight capacity: 22kg



Item no.	Contents
30 60 00 01	0-22kgs

DIGITAL CRANE SCALE

- ▶ Digital LED display
- ▶ DC power supply
- ▶ Auto shut function in 30 minutes



Item no.	Contents
30 60 00 11	100kg
30 60 00 12	200kg
30 60 00 13	500kg
30 60 00 14	1000kg

DIGITAL POCKET BALANCE

- ▶ Each operating by push button, auto shut off in 50 seconds, Memory of heaviest weight, tolerance of 10g, with two result of KGS or LBS by switch option, operated by DV9V battery



Item no.	Contents
30 60 00 02	0-25kgs

DIGITAL KITCHER SCALE



Item no.	Contents
30 60 30 01	5000g

DIGITAL HANGING SCALE

- ▶ Each operating by push button, auto shut off in 50 seconds, Memory of heaviest weight, tolerance of 10g, with two result of KGS or LBS by switch option, operated by DV9V battery



Item no.	Contents
30 60 00 03	25kg
30 60 00 04	40kg
30 60 00 05	50kg

DIGITAL BATHROOM SCALE

- ▶ LED display
- ▶ Max weighing: 150Kg/330lb
- ▶ Division value: 0.1Kg/0.2lb
- ▶ CE,RoHS
- ▶ Glass platform



Item no.	Contents
30 60 30 02	150kg

DIGITAL MULTIMETER

- ▶ 3-1/2" digits LCD, Max reading of 1999
- ▶ Low battery indication
- ▶ Overload protection
- ▶ Audible continuity
- ▶ Voltage DC:200m/2/20/200/600V
- ▶ Voltage AC:200/600V
- ▶ Power source:9V battery



Item no.	Contents
30 70 80 01	

DIGITAL MULTIMETER

- ▶ 3-1/2" digits LCD, Max reading of 1999
- ▶ Low battery indication
- ▶ Overload protection
- ▶ Audible continuity
- ▶ Voltage DC:200m/2/20/200/250V
- ▶ Voltage AC:200/250V
- ▶ Power source:9V battery



Item no.	Contents
30 70 80 02	

DIGITAL MULTIMETER

- ▶ 3-1/2" digits LCD, Max reading of 1999
- ▶ Low battery indication
- ▶ Overload protection
- ▶ Battery check function
- ▶ Audible continuity
- ▶ Voltage DC:200m/2/20/200/250V
- ▶ Voltage AC:200/250V
- ▶ Power source:9V battery
- ▶ GS approved



Item no.	Contents
30 70 80 03	



DIGITAL MULTIMETER

- ▶ 3-1/2" digits LCD, Max reading of 1999
- ▶ Auto power off
- ▶ Data-hold function
- ▶ Low battery indication
- ▶ Overload protection
- ▶ Audible continuity
- ▶ Voltage DC:200m/2/20/200/250V
- ▶ Voltage AC:200/250V
- ▶ Power source:9V battery
- ▶ GS approved



Item no.	Contents
30 70 80 04	

DISTANCE MULTIMETER

- ▶ Range: 40cm-18m
- ▶ Accuracy : +/- (20.5+1digit)(in still air)
- ▶ Resolution:0.01m



Item no.	Contents
30 70 50 01	

MINI DIGITAL MOISTURE METER

- ▶ Measure the moisture level in sawn timber
- ▶ Measure hardened material
- ▶ Measure environment temperature.



Item no.	Contents
30 70 50 05	

DIGITAL MULTIMETER

- ▶ Portable, light weight and small size is easy to carry
- ▶ Data-hold function
- ▶ 3-1/2" digits LCD, Max. reading 1999
- ▶ Overload protection
- ▶ Low battery indication
- ▶ Clamp jaw:Max measurable conductor:Φ27mm
- ▶ Voltage DC:600V
- ▶ Voltage AC:600V



Item no.	Contents
30 70 80 05	

DISTANCE MULTIMETER

- ▶ Range: 55cm-15m
- ▶ Accuracy : +/- (0.5+1digit)(in still air)
- ▶ Resolution:0.01m
- ▶ Calculation:length sum 300m
- ▶ Range: area 225m² volume 3375m³



Item no.	Contents
30 70 50 02	

MOISTURE METER

- ▶ This meter is using a relationship between the dielectric properties and the moisture content of the material to be tested



Item no.	Contents
30 70 50 06	

DIGITAL MULTIMETER

- ▶ Data-hold function
- ▶ 3-1/2" digits LCD, Max. reading 1999
- ▶ Overload protection
- ▶ Low battery indication
- ▶ Maximum value hold mode
- ▶ Automatic zeroing function
- ▶ Clamp jaw:Max measurable conductor:Φ37mm
- ▶ Voltage DC:200m/2/20/200/600V
- ▶ Voltage AC:200/600V
- ▶ Power source:1.5v(AAA)battery x2



Item no.	Contents
30 70 80 06	

4 IN 1 DETECTOR

- ▶ Stud mode:wood stud:30x25mm depth:≤18mm
- ▶ Metal mode:Iron pipe of Φ25mm depth:≤30mm
- ▶ AC mode:Depth of 50mm for 90-250V at 50-60HZ
- ▶ Moisture content:8%-22%



Item no.	Contents
30 70 50 045	

3 IN1 DIGITAL CLOCK

- ▶ Multifunction meter which can measure temperature and humidity.
- ▶ It can display current time and date, and determine whether the environment is comfortable, too wet or too dry.
- ▶ Alarm function, temperature unit selection , storage of max and min.
- ▶ Temperatur



Item no.	Contents
30 70 50 07	

INFRARED THERMOMETER

- ▶ Check temperature of engine, muffler, brakes and more
- ▶ Check temperature of tires and brakes
- ▶ Check for leaks around windows and doors
- ▶ Check temperature of heater vents or air conditioner



Item no.	Contents
30 70 50 08	

BATTERY TESTER



Item no.	Contents
30 70 50 11	

DETECTOR SET



Item no.	Contents
30 70 50 15	Distance measure
30 70 50 16	3 in 1 detector

3-IN-1 VOLTAGE/STUD/METAL DETECTOR

- ▶ Quick and easy operation
- ▶ Light and sound indicate findings



Item no.	Contents
30 70 50 09	

BATTERY BULB, FUSE TESTER



Item no.	Contents
30 70 50 12	

HAND-HELD METAL DETECTOR

- ▶ Detect metal object whose size is same as a 25cent coin.
- ▶ When it detects metal, it will sound or give vibration alarm



Item no.	Contents
30 70 50 10	

ELECTRONIC TROUBLE SHOOTING KIT



Item no.	Contents
30 70 50 13	Non-contact voltage tester
30 70 50 14	Digital multimeter



CUTTING TOOLS

HSS STRAIGHT SHANK TWIST DRILL

- ▶ DIN338
- ▶ High speed steel, straight shank
- ▶ 10pcs or 5 pcs per bag



Item no.	Contents
33 10 00 01	1.0mm
	1.5mm
	2.0mm
	2.5mm
	3.0mm
	3.2mm
	3.5mm
	4.0mm
	4.5mm
	4.8mm
	5.0mm
	5.5mm
	6.0mm
	6.5mm
	7.0mm
	7.5mm
	8.0mm
	8.5mm
	9.0mm
	9.5mm
	10.0mm
	10.5mm
	11.0mm
	11.5mm
	12.0mm
	12.5mm
	13.0mm

HSS TAPER SHANK TWIST DRILL

- ▶ DIN345
- ▶ High speed steel, taper shank



Item no.	Contents
33 20 00 01	7.5mm
	7.8mm
	8.0mm
	8.2mm
	8.5mm
	8.8mm
	9.0mm
	9.2mm
	9.5mm
	9.8mm
	10.0mm
	10.2mm
	10.5mm
	10.8mm
	11.0mm
	11.2mm
	11.5mm
	11.8mm
	12.0mm
	12.2mm
	12.5mm
	12.8mm
	13.0mm
	13.2mm
	13.5mm
	13.8mm
	14.0mm

MASONRY DRILL

- ▶ DIN8039
- ▶ Carbide Tipped



Item no.	Contents
33 40 00 01	4.0mm
	4.5mm
	5.0mm
	5.5mm
	6.0mm
	6.5mm
	7.0mm
	8.0mm
	8.5mm
	9.0mm
	10.0mm
	11.0mm
	12.0mm
	13.0mm
	14.0mm
	16.0mm
	18.0mm
	20.0mm
	22.0mm
	24.0mm
	25.0mm



ELECTRIC HAMMER DRILL

► Carbide tipped



Item no.	Contents
33 40 20 01	5x110mm
	6x110mm
	8x110mm
	6x160mm
	8x160mm
	10x160mm
	12x160mm
	8x210mm
	10x210mm
	12x210mm
	10x260mm
	12x260mm
	14x260mm
	12x300mm
	14x300mm
	16x300mm
	16x450mm
	20x450mm
	25x450mm

ELECTRIC HAMMER CHISEL

► Point



Item no.	Contents
33 40 20 20	14x250mm

ELECTRIC HAMMER CHISEL

► Flat



Item no.	Contents
33 40 20 21	14x250mm

ELECTRIC HAMMER CHISEL

► Extra-flat



Item no.	Contents
33 40 20 22	14x250mm

ELECTRIC HAMMER CHISEL

► Hollow



Item no.	Contents
33 40 20 23	14x250mm

WOOD WORKING DRILLS SET



Item no.	Contents
33 30 20 01	3mm
	4mm
	5mm
	6mm
	7mm
	8mm
	9mm
	10mm
	11mm
	12mm
	13mm
	14mm

FLAT WOOD BITS



Item no.	Contents
33 30 00 01	6mm
	8mm
	10mm
	12mm
	14mm
	16mm
	18mm
	20mm
	22mm
	25mm
	32mm
	38mm

FLAT WOOD DRILL EXTENSION BAR



Item no.	Contents
33 99 00 01	300mm

15PCS DRILL BITS SET

- DIN338
- Titanium coated HSS twist drill
- Packed in plastic box



Item no.	Contents
33 93 00 01	1.5, 2, 2.5, 3, 3.2, 3.5, 4, 4.5, 5, 5.5, 6, 6.5, 8, 10mm

13 PCS TWIST DRILL SET

- DIN338, HSS, straight shank, roll forged, black finish
- Packed in metal box with window



Item no.	Contents
33 93 00 02	1.5, 2.0, 2.5, 3.0, 3.2, 3.5, 4.0, 4.5, 4.8, 5.0, 5.5, 6.0, 6.5mm

19 PCS TWIST DRILL SET

- DIN338, HSS, straight shank, roll forged, black finish
- Packed in metal box with window



Item no.	Contents
33 93 00 03	1.0, 1.5, 2.0, 2.5, 3.0, 3.5, 4.0, 4.5, 5.0, 5.5, 6.0, 6.5, 7.0, 7.5, 8.0, 8.5, 9.0, 9.5, 10.0mm

25 PCS TWIST DRILL SET

- ▶ DIN338, HSS, straight shank, roll forged, black finish
- ▶ Packed in metal box



Item no. Contents

33 93 00 04 1.0, 1.5, 2.0, 2.5, 3.0, 3.5, 4.0, 4.5, 5.0, 5.5, 6.0, 6.5, 7.0, 7.5, 8.0, 8.5, 9.0, 9.5, 10.0, 10.5, 11.0, 11.5, 12.0, 12.5, 13.0mm

115 PCS TWIST DRILL SET

- ▶ DIN338, HSS, straight shank, titanium coated
- ▶ Packed in blow mould case
- ▶ Contents: /116-1/2" by 64ths, 1-60, A-Z



Item no. Contents

33 93 00 09

5 PCS MASONRY DRILL SET

- ▶ Carbide tipped, zinc-plated



Item no. Contents

33 93 00 13 Φ4,5,6,8,10mm

13 PCS TWIST DRILL SET

- ▶ DIN338, HSS, fully ground quality straight shank
- ▶ Packed in transparent plastic box



Item no. Contents

33 93 00 05 1.5, 2.0, 2.5, 3.0, 3.2, 3.5, 4.0, 4.5, 4.8, 5.0, 5.5, 6.0, 6.5mm

115 PCS TWIST DRILL SET

- ▶ DIN338, HSS, straight shank, titanium coated
- ▶ Packed in blow mould case



Item no. Contents

33 93 00 10

3 PCS SDS DRILL SET

- ▶ Work length approx. 750mm
- ▶ Overall length 1,000 mm



Item no. Contents

33 93 00 14 Φ12,16,24 mm

19 PCS TWIST DRILL SET

- ▶ DIN338, HSS, fully ground quality straight shank
- ▶ Packed in transparent plastic box



Item no. Contents

33 93 00 06 1.0, 1.5, 2.0, 2.5, 3.0, 3.5, 4.0, 4.5, 5.0, 5.5, 6.0, 6.5, 7.0, 7.5, 8.0, 8.5, 9.0, 9.5, 10.0mm

115 PCS TWIST DRILL SET

- ▶ DIN338, HSS, straight shank, titanium coated
- ▶ Packed in metal box



Item no. Contents

33 93 00 11

8 PCS MASONRY DRILL SET

- ▶ Carbide tipped, chrome-plated
- ▶ Packed in transparent plastic box



Item no. Contents

33 93 00 15 3, 4, 5, 6, 7, 8, 9, 10mm

25 PCS TWIST DRILL SET

- ▶ DIN338, HSS, fully ground quality straight shank
- ▶ Packed in transparent plastic box



Item no. Contents

33 93 00 07 1.0, 1.5, 2.0, 2.5, 3.0, 3.5, 4.0, 4.5, 5.0, 5.5, 6.0, 6.5, 7.0, 7.5, 8.0, 8.5, 9.0, 9.5, 10.0, 10.5, 11.0, 11.5, 12.0, 12.5, 13.0mm

170 PCS TWIST DRILL SET

- ▶ DIN338, HSS, straight shank
- ▶ Size: 1.0-10.0mm
- ▶ Packed in metal box



Item no. Contents

33 93 00 12

6 PCS SDS HAMMER DRILL SET

- ▶ Tungsten carbide tipped
- ▶ Packed in transparent plastic box



Item no. Contents

33 93 00 16 5x110, 6x110, 8x110mm
6x160, 8x160, 10x160mm

5 PCS WOOD WORKING DRILL SET

- ▶ DIN7487
- ▶ Packed in transparent plastic box



Item no.	Contents
33 93 00 17	4, 5, 6, 8, 10mm

6 PCS WOOD WORKING DRILL SET

- ▶ DIN7487
- ▶ Packed in transparent plastic box



Item no.	Contents
33 93 00 18	3, 4, 5, 6, 7, 8, 9, 10mm

6 PCS FLAT WOOD BITS SET

- ▶ Hexagon quick release shank
- ▶ Packed in blow mould case with window



Item no.	Contents
33 93 00 20	10, 12, 16, 18, 20, 25mm

3 PCS FLAT WOOD BITS SET

- ▶ Hexagon quick release shank
- ▶ With special 3 tips for quick cutting
- ▶ Packed in plastic case



Item no.	Contents
33 93 00 21	12, 20, 25mm

6 PCS FLAT WOOD BITS SET

- ▶ Hexagon quick release shank, black finish
- ▶ With special 3 tips for quick cutting
- ▶ Packed in PVC pouch



Item no.	Contents
33 93 00 22	3/8, 1/2, 5/8, 3/4, 7/8, 1

10 PCS FLAT WOOD BITS SET

- ▶ Hexagon quick release shank
- ▶ Packed in plastic case



Item no.	Contents
33 93 00 23	10, 13, 16, 19, 22, 25, 32, 38mm 1 pc hex key wrench 1 pc Extension bar

14 PCS FLAT WOOD BITS SET

- ▶ Hexagon quick release shank
- ▶ Packed in Wooden case



Item no.	Contents
33 93 00 24	6, 8, 10, 12, 13, 14, 16, 17, 18, 19, 20, 22, 25mm 1 pc. Quick release Holder



8 PCS FLAT WOOD BITS SET

- ▶ Hexagonal shank, with special blade
- ▶ Packed in fine wooden case



Item no.	Contents
33 93 00 25	10, 13, 16, 20, 22, 25, 30, 38mm

6 PCS AUGER BITS SET

- ▶ Single cutting edge
- ▶ Threaded tip for moderate self-feed
- ▶ Black finished inner surface for rust protection
- ▶ Hex shank
- ▶ Packed in wooden case



Item no.	Contents
33 93 00 26	6, 8, 10, 12, 16, 20mm length 230mm

15 PCS AUGER BITS SET

- ▶ Single cutting edge
- ▶ Threaded tip for moderate self-feed
- ▶ Black finished inner surface for rust protection
- ▶ Hex shank
- ▶ Packed in blow mould case



Item no.	Contents
33 93 00 27	

8 PCS AUGER BITS SET

- ▶ Single cutting edge
- ▶ Threaded tip for moderate self-feed
- ▶ Black finished inner surface for rust protection
- ▶ Hex shank
- ▶ Packed in aluminum case with window



Item no. Contents

33 93 00 28 6, 8, 10, 13, 16, 19, 22, 25mm length 230mm

4 PCS COUNTERSINK BITS SET

- ▶ HSS, titanium coated, hollow
- ▶ Packed in wooden case



Item no. Contents

33 93 00 33 2-5, 5-10, 10-15, 15-20mm

18 PCS COMBINATION DRILL SET

- ▶ Packed in transparent plastic round box



Item no. Contents

33 93 00 36 6 pcs HSS twist drill 3,4,5,6,8,10mm
6 pcs masonry drill 3,4,5,6,8,10mm
6 pcs wood working drill 3,4,5,6,8,10mm

6 PCS SAW DRILL SET

- ▶ HSS, milling cutter, hole saw and rotation file
- ▶ suitable for working metal, wood and plastic material
- ▶ Packed in wooden case



Item no. Contents

33 93 00 29 3-4-5-6-6.6-8mm

9 PCS COMBINATION DRILL SET

- ▶ In transparent plastic box



Item no. Contents

33 93 00 34 3 pcs HSS twist drill 5,6,8mm
3 pcs masonry drill 5,6,8mm
3 pcs wood working drill 5,6,8mm

60 PCS COMBINATION DRILL SET

- ▶ Packed in blow mould case



Item no. Contents

33 93 00 37 23 pcs HSS twist drill, titanium coated
1,1.5,2,2.2,2.5,3,3.2,3.5,4,4.4,4.5,4.8,5,5.5,
6,6.6,5,7,7.5,8,8.5,9,10mm
5 pcs flat wood bits, titanium coated
10,12,16,20,22mm
1 Hex key 2.5mm
4 pcs depth stopper, 5,6,8,10mm
9 pcs masonry drill 3,4,5,6,6.7,8,9,10mm
17 pcs wood working drill 2,2.2,3,3.2,3.5,
4,4.4,5,4.8,5.5,6,6.5,7,8,8.9,10mm
1 pc countersink

5 PCS WOODWORKING DRILL WITH COUNTERSINK

- ▶ With integrated countersink
- ▶ Counter sink adjustable to the necessary depth on the drill
- ▶ Packed in wooden case



Item no. Contents

33 93 00 31 4-5-6-8-10mm

15 PCS COMBINATION DRILL SET

- ▶ In transparent plastic box



Item no. Contents

33 93 00 35 5 pcs HSS twist drill 4,5,6,8,10mm
5 pcs masonry drill 4,5,6,8,10mm
5 pcs wood working drill 4,5,6,8,10mm

101 PCS DRILL AND BITS SET

- ▶ Packed in blow mould case



Item no. Contents

33 93 00 38 22 pcs 25mm bit: SL 4, 5, 6, 7mm;
PH 1, 2, 3; PZ 1, 2, 3; TX 10, 15, 20,
25, 30; S 1, 2, 3
19 pcs HSS drill, titanium coated:
1, 1.5, 2, 2.5, 2x3, 3.2, 3.5, 2x4 4.5,
2x5, 5.5, 6, 6.5, 7, 7.5, 8mm
5 pcs flat wood bit, titanium coated
10, 12, 16, 20, 22mm
10 pcs socket bits: 5, 5.5, 6,
7, 8, 9, 10, 11, 12, 13mm
6 pcs wood drill: 3, 4, 5, 6, 7, 8mm
1 pc countersink
4 pcs depth stopper
1 pc hex key 2.5mm
1 pc arbor
6 pcs masonry drill 3, 4, 5, 6, 7, 8mm
4 pcs hole saw 32, 38, 44, 54mm
3 pcs HSS drill, titanium coated, 2, 3, 4mm
3 pcs long bit guide
15 pcs 50mm bits: SL 4, 5, 6, 7mm PH 1,
2, 3 PZ 1, 2, 3 TX: 10, 15, 20, 25, 30
1 pc magnetic holder

17 PCS COMBINATION DRILLSET

► Packed in wooden case



Item no.	Contents
33 93 00 39	1 pc countersink 6 pcs wood drill 3,4,5,6,8,10mm 5 pcs milling bits, titanium coated: 4,5,6,8,10mm 5 pcs masonry drill: 4,5,6,8,10mm

300 PCS DRILL & BIT SET

► Packed in blow mould case



Item no.	Contents
33 93 00 44	7-pcs. HSS Twist drills, titanium coated, 2-3-4-6-8-10mm 5 pcs. Wood drills, titanium coated, 4-5-6-8-10mm 6 pcs. Bits, 25mm long 1 pcs. HSS saw drill 6mm 1 pc. Magnetic bits holder 308 pcs. Wood screws + wall plugs: 4mm / 98 pcs. 5mm / 50 pcs. 6mm / 40 pcs. 8mm / 20 pcs. 10mm / 10 pcs. Wood screws: 3x20mm/35 pcs., 3x30mm/25 pcs., 4x40mm/12 pcs., 5x50mm/10 pcs. 5x60mm / 8 pcs.

301 PCS DRILL & BIT SET

► Packed in blow mould case



Item no.	Contents
33 93 00 45	7 pcs HSS drill: 2,3,4,5,6,8,10mm 5 pcs masonry drill: 4,5,6,8,10mm 5 pcs wood drill: 4,5,6,8,10mm 6 pcs 25mm bits: SL4,5,6; PH2; PZ1;PZ2 1 pc HSS milling drill 6mm 1 pc magetic bit holder Assortment of wood screw and plugs

118 PCS COMBINATION DRILL SET

► Packed in blow mould case



Item no.	Contents
33 93 00 40	13 pcs HSS drill, titanium coated: 1.5,2,2.5,3,3.2,3.5,4,4.5,4.8,5,5.5,6,6.5mm 3 pcs Hss drill, titanium coated with hex shank: 1.5,2,3mm 4 pcs wood drill: 4,5,6,8mm 5 pcs flat wood bit: 5,6,8,10mm 1 pcs enter drill 1 pc quick release adaptor 1 pc magnetic holder 1 pc drill guage 18 pcs 50mm bits 18 pcs 25mm bits 30 pcs 25mm bits 1 pc stainless steel ruler 9 pcs sockets bits: 5,6,7,8,9,10,11,12,13mm 4 pcs sand ring: 13,19,25,25mm

149 PCS COMBINATION DRILL SET

► Packed in blow mould case



Item no.	Contents
33 93 00 41	41 pcs HSS drill, titanium coated: 4x1.5,2.0,2.5,3.2mm 3x3.0,4.0mm 2x3.5,4.5,4.8,5.5,6.5mm 1x5,6,7,7.5,8,8.5,10,11,13mm 17 pcs wood drill: 3,3.2,3.5,4,4.5,4.8,5,5.5,6,6.5,7,7.5,8,8.5,9,9.5,10mm 8 pcs masonry drill: 3,4,5,6,7,8,9,10mm 6 pcs flat wood bit: 10,13,16,19,22,25mm 4 pcs HSS drill with hex shank: 1.5,2,3,4mm 40 pcs 25mm bits: PH0,1,2,3 SL3,4,5,5.5,6,7mm PZ0,1,2,2,3 TX6,7,8,9,10,15,20,25,27,30,35,40 HEX1.5,2,2.5,3,3.5,4,4.5,5,5.5,6,6.5,7 10 pcs 50mm bits: SL3,5,6,7 PH1, 2, 3 PA1, 2, 3 9 pcs socket bit: 5,6,7,8,9,10,11,12,13mm 3 pcs depth stopper: 6, 8, 10mm 1 pc magnetic holder 5 pcs hole saw: 32, 38, 44, 54mm 1 pc arbor 4 pcs sand cloth ring: 13, 19, 25, 25mm

215 PCS DRILL AND BIT SET

► Packed in blow mould case



Item no. Contents

33 93 00 46	42 pcs HSS drill: 4x1.2, 4x1.5, 4x2.5, 4x3, 4x3.2, 4x3.5, 4x4, 4.5, 5, 5.5, 6, 6.5, 7, 7.5, 8, 9, 9.5
	45 pcs HSS drill, titanium coated: 4x1.2, 4x1.5, 4x2, 4x2.5, 4x3, 4x3.2, 4x3.5, 4x4, 4.5, 4.8, 2x5, 5.5, 6, 4x6.5, 7, 7.5, 8mm
	10 pcs bit sockets: 5, 5.5, 6, 7, 8, 9, 10, 11, 12, 13mm
	21 pcs 50mm bits: SL 4, 5, 5.5, 6, 7mm; PH1, 2, 2.2, 2.3; TX20, 25, 30, 40; S1, 2, 2.2, 3
	31 pcs 25mm bits: SL: 4, 5, 5.5, 6, 7; PH1, 2, 2.2, 2.3; PZ1, 2, 2.2, 2.3; TX10, 15, 20, 25, 27, 30, 40, 45; HEX3, 4, 5, 6; S1, 2, 3
	3 pcs HSS drill, titanium coated with hexagon shank 2, 3, 4mm
	1 pc countersink
	3 pcs bits guide
	3 pcs metal drill stopper
	1 pc magnet adaptor
	3 pcs masonry drill: 8, 10, 12x300mm
	21 masonry drill: 2x3, 2x4, 2x4.5, 2x5, 2x5.5, 3x6, 2x6.5, 3x7, 8, 9, 10mm
	4 pcs nail punch
	7 pcs flat wood bits 10, 12, 14, 16, 18, 22, 25mm
	12 pcs wood drill: 3x3, 3x4, 5, 6, 7, 8, 9, 10mm
	1 pc extension bar 300mm
	1 pc Hex key 2.5mm
	4 pcs holesaw 32, 38, 45, 54mm
	1 pc arbor
	1 pc drill gauge



15PC. WOOD DRILL SET

► Packed in plastic box



Item no. Contents

33 93 01 01	3.0X3pc, 3.5X2pc, 4.0X2pc, 4.5, 5.0, 5.5, 6.0X2pc, 6.5, 8.0, 10.0
--------------------	-------------------------------------------------------------------

15PC. MASONRY DRILL SET

► Packed in plastic box



Item no. Contents

33 93 01 02	3.0X3pc, 4.0X3pc, 5.0X3pc, 6.0X2pc, 8.0X2pc, 10.0X2pc
--------------------	-------------------------------------------------------

100PCS TWIST DRILLS SET

► Packed in plastic box



Item no. Contents

33 93 01 04	Twist drill bits, polished: 1/16"X19, 5/64"X12, 3/32"X19, 7/64"X19, 1/8"X12, 9/64"X3, 5/32"X3, 11/64"X3, 3/16"X3, 13/64"X3, 7/32"X3, 15/64"X3, 1/4"X3, 9/32"X1, 5/16"X1.
--------------------	--------------------------------------------------------------------------------------------------------------------------------------------------------------------------

105PCS DRILL & BIT SET

► Packed in blow mould case



Item no. Contents

33 93 01 05	19pcs twist drill bits, polished: 1/16"X3, 5/64"X2, 3/32"X2, 7/64"X2, 1/8"X2, 9/64", 5/32", 11/64", 3/16", 13/64", 7/32", 15/64", 1/4". 7pcs nutdriver: 1/4", 9/32", 5/16", 11/32", 3/8", 7/16", 1/2". 40pcs 1" screwdriver bit, 6150CrV: 10pc SL: 1/8"X2, 5/32"X2, 3/16"X3, 1/4"X3. 7pc PH: #1X2, #2X3, #3X2. 7pc PZ: #1X2, #2X3, #3X2. 7pc TORX: T10, T15, T20, T25, T27, T30, T40 6pc HEX: 5/64", 3/32", 1/8", 5/32", 3/16", 1/4" 3pc Square: S1 S2 S3 12pcs 2" screwdriver bits: 2pc SL: 3/16" 1/4" 3pc PH: #1 #2 #3 4pc HEX: 1/8", 5/32", 3/16", 1/4" 3pc Square: S1, S2, S3 6pcs masonry drill bits: 5/32", 3/16", 1/4", 5/16", 3/8", 3/8". 4pcs hex key: 5/64", 1/8", 5/32", 3/16". 1pcs magnetic holder 1pcs countersink 4pcs hole saws with hole saw adapter: 1-1/4", 1-1/2", 1-3/4", 2-1/8". 1pcs holesaws adaptor 5pcs wood-boring drill bits: 5/32", 3/16", 1/4", 5/16", 3/8". 4pcs flat wood bits: 3/8", 1/2", 5/8", 3/4". 1pcs plastic gauge
--------------------	------------------------------------------------------------------------------------------------------------------------------------------------------------------------------------------------------------------------------------------------------------------------------------------------------------------------------------------------------------------------------------------------------------------------------------------------------------------------------------------------------------------------------------------------------------------------------------------------------------------------------------------------------------------------------------------------------------------------------------------------------------------------------------------------------------------------------------------------------------------------------------------------------------------------------------------------------------------------------------------------------------------------------

1110PCS DRILL AND BIT SET

► Packed in blow mould case



Item no. Contents

33 93 01 06	10pcs twist drill bits with black finish: 1/16", 5/64", 3/32", 7/64", 1/8", 9/64", 5/32", 3/16", 7/32", 1/4" 5pcs masonry drill bit: 1/8", 5/32", 3/16", 1/4", 5/16" 5pcs wood drill bit: 1/8", 5/32", 3/16", 1/4", 5/16" 3pcs wood spade bit: 3/8 1/2 5/8" 50pcs 25mm screwdriver bit: 10pc Slotted: 1/8"X2 5/32"X2 3/16"X2 1/4"X2 9/32"X2 10pc Phillips: #13 #24 #33 10pc Posi: #13 #24 #33 7pc Square: S1X2 S2X3 S3X2 7pc Torx: T10, T15, T20, T25, T27, T30, T40 6pcs Hex: 5/64" 3/32" 1/8" 5/32" 3/16" 1/4" 10pcs 50mm screwdriver bit: 4pc Slotted: 1/8" 5/32" 3/16" 1/4" 3pc Phillips: #1 #2 #3 3pc Posi: #1 #2 #3 3pc Nutdriver: 5/32" 3/16" 7/32" 1/4" 9/32" 5/16" 11/32" 3/8" 5pcs plastic bit holder 5pcs drill stop: 1/8", 1/4", 5/16" 4pcs hole saws: 1-1/4", 1-1/2", 1-3/4", 2-1/8" 1pcs holesaws adaptor 1pcs plastic gauge 1pcs screw finder 1pcs bit holder 1pcs countersink 1pcs hex key 1pcs BMCV
--------------------	-------------------------------------------------------------------------------------------------------------------------------------------------------------------------------------------------------------------------------------------------------------------------------------------------------------------------------------------------------------------------------------------------------------------------------------------------------------------------------------------------------------------------------------------------------------------------------------------------------------------------------------------------------------------------------------------------------------------------------------------------------------------------------------------------------------------------------------------------------------------------------------------------------------------------------------------------------------------------------------------------

41PCS DRILL AND BIT SET

► Packed in blow mould case



Item no.	Contents
33 93 01 07	14pcs 50mm screwdriver bits, 6150CrV: 2pc slotted: 5mm, 6mm 6pc TORX: T10 T15 T20 T25 T30 T40 6pc HEX: 2, 2.5, 3, 4, 5, 6mm 7pcs 100mm double screwdriver bits, 6150CrV: 4pc PH: PH2-PH2 3pc PZ: PZ2-PZ2 6pcs 65mm double screwdriver bits, 6150CrV: 3pc PH: PH2-PH2 3pc PZ: PZ2-PZ2 7pcs nutdriver: 5.5, 6, 7, 8, 10, 12, 13mm, 50BV30 5pcs HSS twist drill with hex shank: 1.5, 2.5, 3, 4, 5mm 1pc 50mm adaptor 1pc magnetic holder

21PCS DRILL AND BIT SET

► Packed in blow mould case



Item no.	Contents
33 93 01 08	8pcs HSS twist drill bits, with Hex shank: 1, 1.5, 2, 2.5, 3, 4, 5, 6mm 8pcs screwdriver bits, 6150CrV 4pcs power sockets, with magnetic: 6, 8, 10, 11mm 1pc quick release bit holder

29PCS TWIST DRILL SET

► Packed in plastic box



Item no.	Contents
33 93 01 09	1/16, 5/64, 3/32, 7/64, 1/8, 9/64, 5/32, 11/64, 3/16, 13/64, 7/32, 15/64, 1/4, 17/64, 9/32, 19/64, 5/16, 21/64, 11/32, 23/64, 3/8, 25/64, 13/32, 27/64, 7/16, 29/64, 15/32, 31/64, 1/2"

19PCS TWIST DRILL SET

► Packed in plastic box



Item no.	Contents
33 93 01 10	1, 1.5, 2, 2.5, 3, 3.5, 4, 4.5, 5, 5.5, 6, 6.5, 7, 7.5, 8, 8.5, 9, 9.5, 10mm

110PCS DRILL AND BIT SET

► Packed in blow mould case



Item no.	Contents
33 93 01 11	13pcs twist drill bits : 1.5, 2, 2.5, 3, 3.2, 3.5, 4, 4.5, 4.8, 5, 5.5, 6, 6.5mm 4pcs wood drill bits: 4, 5, 6, 10mm 4pcs masonry drill bits : 4, 5, 6, 10mm 3pcs wood spade bits: 10, 12, 16mm 50pcs 25mm screwdriver bits : 10pcs Slotted: 3x2 4x2 5x2 6x2 7x2 10pcs Phillips: #1*3 #2*4 #3*3 10pcs Pozzi: #1*3 #2*4 #3*3 7pcs Square: s1x2 s2x3 s3x2 7pcs Torx: T10, T15, T20, T25, T27, T30, T40 6pcs Hex: 2, 2.5, 3, 4, 5, 6mm 10pcs 50mm screwdriver bits : 4pcs Slotted: 3, 4, 5, 6mm 3pcs Phillips: #1, #2, #3 3pcs Pozzi: #1, #2, #3 7pcs nutdriver: 5, 5.5, 6, 7, 8, 9, 10mm 5pcs plastic bit holder 3pcs drill stoper: 3, 5, 8mm 4pcs hole saws: 32, 38, 44, 54mm 1pc holesaws adaptor 1pc plastic gauge 2pcs screw finder 1pc bit holder 1pc counter sink 1pc hex key

31PCS SCREWDRIVER BIT, POWER DRILL SET

► Packed in plastic case



Item no.	Contents
33 93 01 12	20pcs 25mm screwdriver bits: PH: 1, 2, 3 PZ: 1, 2, 3 TORX: T10, T15, T20, T25, T27, T30, T40 SL: 4, 5, 6mm HEX: H2, H3, H4, H5, H6 1pcs 60mm magnetic bit holder 1pcs 1/4" Driver socket adapter 3pcs 50mm screwdriver bits: PH:2, PZ2, SL: 5mm 1pcs 50mm socket adapter 2pcs 110mm SDS hammer drill bit: 5, 6mm 3pcs 160mm SDS hammer drill bit: 6, 8, 10mm 1pcs 100mm SDS magnetic bit holder

42PCS SCREWDRIVER BIT, POWER DRILL SET

► Packed in plastic case



Item no.	Contents
33 93 01 13	23pcs 25mm screwdriver bits: PH: 1, 2, 3 PZ: 1, 2, 3 TORX: T10, T15, T20, T25, T27, T30, T40 SL: 4, 5, 6 HEX: H2, H3, H4, H5, H6 SQUARE: S1, S2, S3 TORX: T10, T15, T20, T25, T27, T40 2pcs 60mm magnetic bit holder 5pcs wood drill bit: 3, 4, 5, 6, 8 5pcs masonry drill bit: 4, 5, 6, 8, 10 5pcs HSS white drill bit: 3, 4, 5, 6, 8 1pcs magnetic quick change chuck

41PCS SCREWDRIVER BIT, POWER DRILL SET

► Packed in plastic case



Item no.	Contents
33 93 01 14	17pcs 25mm screwdriver bits: PH: 1, 2, 3 PZ: 1, 2, 3 TORX: T10, T15, T20, T25, T27, T30, T40 SL: 4, 5, 6, 7mm 1pcs 60mm magnetic bit holder 5pcs wood drill bit: 3, 4, 5, 6, 8mm 5pcs masonry drill Bit: 4, 5, 6, 8, 10mm 12pcs HSS white drill Bit: 2, 2.5, 3, 3.5, 4, 4.5, 5, 5.5, 6, 6.5, 7, 8mm

24PCS POWER DRILL SET

▶ Packed in plastic case



Item no.	Contents
33 93 01 15	24pc HSS drill bit: 1, 1, 1.5, 1.5, 2, 2.5, 3, 3.5, 4, 4.5, 5, 5.5, 6, 6.5, 7, 7.5, 8, 8.5, 9, 10mm 1pcs counter sink 1pcs scriber 1pcs steel ruler 1pcs steel punch

23PCS WOOD WORKING TOOL SET

▶ Packed in plastic case



Item no.	Contents
33 93 01 16	5pcs wood drill bit: 3, 4, 5, 6, 8mm 5pcs counter sinks for wood drill bit: 3, 4, 5, 6, 8mm 4pcs carbon steel hole saw: 32, 38, 44, 55mm 1pcs hole saw arbor 1pcs Hex key 1pcs counter sink 4pcs wood flat drill bit: 16, 18, 20, 22mm 2pcs stop end bit

3 PCS STEP DRILL BIT SET

▶ Titanium coated
▶ Packed in wooden case



Item no.	Contents
33 93 00 48	4-12, 4-20, 4-32mm

4 PCS COMBINATION DRILL SET

▶ HSS, Titanium coated
▶ Packed in wooden case



Item no.	Contents
33 93 00 49	1 pc countersink 12.4mm 1 pc step drill 4-12mm 1 pc drill saw 6mm 1 pc umbrella drill 8-20mm

GLASS DRILL

▶ Work length approx. 750mm
▶ Overall length 1,000 mm



Item no.	Contents
33 99 00 02	2mm, 3mm, 4mm, 6mm, 8mm, 10mm, 12mm, 14mm, 16mm

STROKE DRILLING WINDER

▶ Tungsten carbide blades
▶ SDS-shank



Item no.	Contents
33 25 40 01	68mm
33 25 40 02	80mm

SDS CHUCK ADAPTOR



Item no.	Contents
33 40 30 01	

4 PCS WALL HOLE SAW SET

▶ In aluminum case



Item no.	Contents
33 93 00 51	2 pcs carbide tipped hole saw 60mmX55mm, 80mm X50mm, 1 pc SDS-plus adaptor 100mm 1 pc TCT drill 8X110mm

3 PCS SDS HAMMER CHISEL SET

▶ Packed in blow mould case



Item no.	Contents
33 93 00 53	30x410mm

17 PCS SDS HAMMER DRILL & CHISEL SET

▶ Packed in blow mould case



Item no.	Contents
33 93 00 54	13 pcs SDS hammer drill: 5.5, 6x110; 5.5, 6, 6.5, 7, 7.8, 10X160; 14x210; 10, 12, 16x260mm 1 pc point chisel: 14x250mm 2 pcs flat chisel: 14x250x20; 14x250x40mm 1 pc U groove chisel 14x250mm

17 PCS SDS HAMMER DRILL & CHISEL SET

► Packed in iron case



Item no.	Contents
33 93 00 55	12 pcs SDS hammer drill : 5,6,8,10x110mm; 6,8,10,12x160mm; 8,10x210mm; 12,14x260mm 2 pcs point chisel: 14x143mm; 14x250mm 3 pcs flat chisel: 14x143x20mm, 14x250x20mm, 14x250x40mm

10 PCS SDS HAMMER DRILL SET

► Packed in aluminum case with window



Item no.	Contents
33 93 00 56	5x110, 6x110, 6x160, 8x160, 10x450, 10x160, 12x450, 10x210, 16x450, 12x210, 20x450MM

MULTI ANGLE DRILL BIT



Item no.	Contents
33 50 00 01	7, 10, 12, 15, 18, 20, 22, 25, 28, 30, 32, 35mm

10 PCS COMBINATION DRILL SET

► Packed in blow mould case



Item no.	Contents
33 93 00 61	4 pcs MAD bit 15-18-20-22mm 5 pcs HSS drill 4-5-6-8-10mm 1 pc drill saw 6mm

4 PCS MAD BIT SET

► Packed in plastic case



Item no.	Contents
33 93 00 62	3/8"-1/2"-3/4"-1"

11 PCS COMBINATION DRILL SET

► Packed in plastic box



Item no.	Contents
33 93 00 63	3 pcs MAD bit: 10-15-20mm 8pcs HSS drill: 3-3.5- 4-4.5-5-5.5-6-6.5mm

TCT FORSTNER BIT



Item no.	Contents
33 99 00 03	12mm
33 99 00 04	14mm
33 99 00 05	15mm
33 99 00 06	16mm
33 99 00 07	17mm
33 99 00 08	18mm
33 99 00 09	19mm
33 99 00 10	20mm
33 99 00 11	21mm
33 99 00 12	22mm
33 99 00 13	23mm
33 99 00 14	24mm
33 99 00 15	25mm
33 99 00 16	26mm
33 99 00 17	28mm
33 99 00 18	30mm
33 99 00 19	32mm
33 99 00 20	35mm
33 99 00 21	40mm
33 99 00 22	42mm
33 99 00 23	45mm

5 PCS FORSTNER BIT SET

► Packed in wooden box



Item no.	Contents
33 93 00 64	15,20,25,30,35mm

7 PCS FORSTNER BIT SET

► Packed in blow mould case



Item no.	Contents
33 93 00 65	6,10,13,16,19,22,25mm

6 PCS. CARBIDE ROUTER BITS SET

► Packed in wooden case



Item no.	Contents
33 93 00 67	1 pc round over bit: 1/4"x31.8xR9.5mm 1 pc roman ogee bit: 1/4"x25.4xR4mm 3 pcs straight bit: 1/4"x6.35x15.9, 1/4"x12.7x19, 1/4"x9.5x19 1 pc core box bit: 1/4"x12.7xR6.35mm





12 PCS. CARBIDE ROUTER BITS SET

► Packed in wooden case



Item no.	Contents
33 93 00 68	2 pcs bottom cleaning bit: 8, 16mm 1 pc core box bit: R6mm 1 pc 60 degree V grooving bit: 15mm 1 pc dovetail bit: 16mm 1 pc flush trim bit: 19mm 1 pc 45 degree chamfer bit: 27mm 2 pcs round over bit: R6, R10mm 2 pcs cove bit: R6, R10mm 1 pc roman ogee bit: R6.5mm

12 PCS. CARBIDE ROUTER BITS SET

► Packed in blow mould case



Item no.	Contents
33 93 00 95	2 pcs bottom cleaning bit: 8, 16mm 1 pc core box bit: R6mm 1 pc 60 degree V grooving bit: 15mm 1 pc dovetail bit: 16mm 1 pc flush trim bit: 19mm 1 pc 45 degree chamfer bit: 27mm 2 pcs round over bit: R6, R10mm 2 pcs cove bit: R6, R10mm 1 pc roman ogee bit: R6.5mm

15 PCS. CARBIDE ROUTER BITS SET

► Packed in wooden case



Item no.	Contents
33 93 00 69	1 pc flush trim bit: 1/4" 1 pc Straight: 1/4" 1 pc Mortising: 1/2" 1 pc Dovetail: 1/2" 1 pc Straight: 1/2" 1 pc Panel Pilot: 1/4" 1 pc Straight: 3/4"mm 1 pc slot cutter bit: 1-1/4" 1 pc 90 degree Grooving 3/8" 1 pc Flush Trim: 1/2" 1 pc 45 degree Chamfer 1-3/16" 1 pc Round Over: 3/8" 1 pc 7 degree trim bit: 13/64" 1 pc Roman Ogee bit: R5/32" 1 pc Cove bit: R1/2"

18PCS QUICK-CHANG FLAT DRILL WITH AUGER BIT

► Packed in wooden case



Item no.	Contents
33 93 00 80	

15 PCS. CARBIDE ROUTER BITS SET

► Packed in aluminum case



Item no.	Contents
33 93 00 70	1 pc Core Box Bit: 6.35mm 1 pc Straight: 3, 2mm 1 pc Mortising: 12.7mm 1 pc Dovetail: 12.7mm 1 pc Straight: 6.35mm 1 pc Panel Pilot: 6.35mm 1 pc Straight: 12.7mm 1 pc Straight: 19.0mm 1 pc 90 degree Grooving 9.5mm 1 pc Flush Trim: 12.7mm 1 pc 45 degree Chamfer 30.0mm 1 pc Round Over: 9.5mm 1 pc Rabbet bit: 9.5mm 1 pc Roman Ogee: 4.0mm 1 pc Cove: 12.7mm

24 PCS ROUTER BIT SET

► Packed in wooden case



Item no.	Contents
33 93 00 72	4 pcs straight bit: 1/4", 3/8", 1/2", 3/4" 1 pc cover box bit: R1/2" 1 pc mortising bit: R1/2" 1 pc mortising bot: 1/2" 1 pc V grooving bit: 1/2" 1 pc Key hole bit: 1/4" 1 pc roun nose bit: 1/4" 1 pc panel pilot bit: 1/4" 1 pc roman ogee bit: R5/32" 1 pc flush trim bit: 1/2" 2 pcs dovetail bit: 3/8", 1/2" 1 pc rabbeting bit: 7/8" 2 pcs Cove bit: R1/4", R3/8" 1 pc 45 degree chamfer bit: 1" 4 pcs round over bit: R1/8", R1/4", R3/8", R1/2" 1 pc half round bit: 3/16" 1 pc ovolo bit: 1/4"

18 PCS ROUTER BIT SET

► Packed in wooden case



Item no.	Contents
33 93 00 71	2 pcs round nose bit: 1/4", 1/2" 3 pcs straight bit: 1/4", 1/2", 3/4" 2 pcs 90 degree grooving bit: 3/8", 1/2" 2 pcs dovetail bit: 3/8", 1/2" 1 pc flush trim bit: 3/8" 1 pc 45 degree chamfer bit: 3/8" 3 pcs round over bit: R1/4", R3/8", R1/2" 2 pcs roman ogee bit: R5/32", R1/4" 1 pc beading bit: R1/4" 1 pc cove bit: R1/2"

HOLE SAW



Item no.	Contents
33 50 20 10	

CARBIDE GRIT HOLE SAW

- Self-sharpening, 2-1/4" cutting depth
- Applied: tile, concrete, etc.
- Size: 33,43,53,63,67,73,83,103mm



Item no.	Contents
33 50 20 01	

ARBOR

- Shank size: 1/4 round
- Thread size: 1/2-20 UNF
- Chuck size: 1/4"
- For saw: 13-30mm



Item no.	Contents
33 99 00 24	

ARBOR

- ▶ Shank size: 7/16 hex
- ▶ Thread size: 5/8-18 UNF
- ▶ Chuck size: 1/2"
- ▶ For saw: 32-200mm



Item no.	Contents
33 99 00 25	

ARBOR

- ▶ Shank size: 7/16 hex
- ▶ Thread size: 5/8-18 UNF
- ▶ Chuck size: 1/2"
- ▶ For saw: 32-230mm



Item no.	Contents
33 99 00 26	

3 PCS LOCK INSTALLATION SET



Item no.	Contents
33 99 00 01	1 pc hole saw 54mm 1 pc wood flat bits 22mm 1 pc arbor

5 PCS HOLE SAW SET



Item no.	Contents
33 99 00 02	4 pcs hole saw: 32,38,44,51mm 1pc arbor 1pc hex key 2.5mm

11 PCS HOLE SAW SET

- ▶ Packed in blow mould case



Item no.	Contents
33 90 00 03	8 pcs hole saws 25,32,38,44,51,64mm 2 pcs arbor 1pc hex key 2.5mm

14 PCS HOLE SAW SET

- ▶ Packed in blow mould case



Item no.	Contents
36 90 00 20	12pcs hole saws, 2 pcs arbor

8 PCS HOLE SAW SET

- ▶ Packed in blow mould case



Item no.	Contents
33 90 00 04	2 pcs arbors 1 pc hex key wrench 2.5mm 12 pcs hole saw: 19,22,29,32,38,44,51,64,76,89,102,127mm 1 pc driver plate

31 PCS HOLE SAW SET

- ▶ Packed in blow mould case



Item no.	Contents
33 90 00 05	13 pcs hole saw: 19,22,25,29,35,44,51,65,70,80,85,100,125mm 2 pcs arbors 1 pc driver plate 4 pc wood falt bits 20 25 30 35mm 4 pcs tapered countersink drill bits: 3,4,5,6# 4pcs wood fornerster bits: 20,25,30,35mm

17 PCS HOLE SAW SET

- ▶ Packed in blow mould case



Item no.	Contents
33 90 00 06	2pc arbor 1pc hex key 2.5mm 8 pc hole saws: 19,22,29,32,38,44,51,65mm 6pc drill saw 3,4,5,6,5,8mm

13 PCS BI-METAL HOLE SAW SET

- ▶ Max. cutting depth 35mm
- ▶ Packed in aluminum case



Item no.	Contents
33 90 00 07	9 pcs bi-metal hole saws: 19,22,29,35,38, 44,51,57,64mm 2 Arbors complete with 6mm Hss pilot drill 1 pc extension bar

10 PCS BI-METAL HOLE SAW SET

- ▶ Max. cutting depth 35mm
- ▶ Packed in blow mould case



Item no.	Contents
33 90 00 08	6 pcs bi-metal hole saws: 22,28, 35, 44, 67, 73mm 2 Arbors complete with 6mm Hss pilot drill 2 pcs adaptor



Hicen[®]



16 PCS BI-METAL HOLE SAW SET

- ▶ Max. cutting depth 35mm
- ▶ Packed in aluminum case



Item no.	Contents
33 90 00 09	13 pcs bi-metal hole saws: 19, 20, 22, 25, 29, 32, 35, 38, 44, 51, 57, 67, 76mm; 2 Arbors complete with 6mm Hss pilot drill 1 pc extension shank 250mm

11 PCS HOLE SAW SET

- ▶ Hardened electrophoresis lacquered hole saw
- ▶ Black finish drill
- ▶ Packed in blow mould case



Item no.	Contents
33 90 00 10	8 hole saws: 19, 22, 28, 38, 44, 51, 64mm 2 mandrel drill bits with L type hexagon key

7 PCS CARBIDE GRIT HOLE SAW SET

- ▶ Packed in blister



Item no.	Contents
33 90 00 11	5 pcs hole saw: 35,53,67,73,83mm 1 pc TCT center drill 1 pc aluminum cap

7 PCS CARBIDE GRIT HOLE SAW SET

- ▶ Packed in blow mould case



Item no.	Contents
33 90 00 12	5 pcs hole saw: 35,53,67,73,83mm 1 pc TCT center drill 1 pc aluminum cap

8 PCS CARBIDE GRIT HOLE SAW SET

- ▶ Packed in blow mould case



Item no.	Contents
33 90 00 13	5 pcs hole saw: 35,53,67,73,83mm 1 pc TCT center drill 1 pc aluminum cap 1 pc carbide grit file

9 PCS CARBIDE GRIT HOLE SAW SET

- ▶ Packed in blow mould case



Item no.	Contents
33 90 00 14	6 pcs hole saw: 22,29,35,44,51,64mm 2 pcs arbor 1 pc adaptor

3 PCS LOCK INSTALLATION SET



Item no.	Contents
33 90 00 15	1 pc hole saw 2-1/8" (54mm) 1 pc aguer bit 7/8" (22mm) 1 pc hex key



ADJUSTABLE CIRCLE HOLE SAW

- ▶ Adj. range:30-120mm



Item no.	Contents
33 99 00 27	

ADJUSTABLE FLAT WOOD BITS

- ▶ Adj. range: 22-40,40-76;15-38;16-45mm
- ▶ Length: 125, 150,175,180,200mm



Item no.	Contents
33 99 00 28	

11 PCS HOLE SAW AND DIAMOND DISC SET

- ▶ Packed in blow mould case



Item no.	Contents
33 90 00 16	6 pcs carbide coated hole saw: 22mm(7/8")-28mm(1-1/8")-35mm(1-3/8")-44mm(1-3/4")-67mm(2-5/8")-73mm(2-7/8") 2pcs arbors 1pc hex key 2.5mm 2pcs 150mm diamond blade

9 PCS DIAMOND HOLE SAW SET

- ▶ Packed in blow mould case



Item no.	Contents
33 90 00 17	6 pcs hole saw: 7/8"(22mm), 1-1/8"(29mm), 1-1/2"(38mm), 1-3/4"(44mm), 2-5/8"(67mm), 2-7/8"(73mm), 2pcs arbors 1pc hex key 2.5mm

9PCS CARBIDE HOLE SAW SET

► Packed in blow mould case



Item no.	Contents
33 90 00 18	6PCS Hole Saws:7/8"(22mm), 1-1/8"(29mm),1-1/2"(38mm), 1-3/4"(44mm),2-5/8"(67mm), 2-7/8"(73mm) 2PCS Arbors:XWY-01A002, 3/8"(9.5mm)Hex,Fits hole saw 1/2"-1-3/16"(13-30mm) XWY-01A008,7/16"(11mm)Hex,Fits hole saw 1-1/4"-9-1/16"(32-230mm) 1PCS adapter:XWY-01AA001 1/2"-20UNF-5/8"-18UNF

9PCS BI-METAL HOLE SAW SET(PLUMBER)

► Packed in blow mould case



Item no.	Contents
33 90 00 19	6PCS Hole Saws:3/4"(19mm), 7/8"(22mm),1-1/8"(29mm), 1-1/2"(38mm),1-3/4"(44mm), 2-1/4"(57mm) 2PCS Arbors:XWY-01A002, 3/8"(9.5mm)Hex,Fits hole saw 1/2"-1-3/16"(13-30mm) XWY-01A008,7/16"(11mm)Hex,Fits hole saw 1-1/4"-9-1/16"(32-230mm) 1PCS Hex Wrench: XWY-01AK001 5/32"(4mm)

9PCS TUNGSTEN CARBIDE GRITTED HOLE SAW SET

► Packed in blow mould case



Item no.	Contents
33 90 00 20	6PC Hole Saws:7/8"(22mm), 1-1/8"(29mm),1-1/2"(38mm), 1-3/4"(44mm),2-5/8"(67mm), 2-7/8"(73mm) 2PC Arbor 1PC Hex Key Wrench:2.5mm

ELECTROPLATED DIAMOND CORE DRILL BITS



Item no.	Contents
33 90 00 21	Dia:Φ4-150mm Grit:#30 #40 #60 #80 Diamond Brazed Core Drill Bits With M14 or 5/8"-11 Thread



T.C.T HOLE SAW

- Size range: φ16mm to φ100mm
- With fluth design for getting rid of the chips easily.
- Adapting big carbide tips to enforce the brazing firmly.
- Tips ground to have sharp cutting edge to get power-ful cutting edge to get power-ful cutting.
- Strong body plus special tretment to make a solid structure for tough cutting.
- Main application:stainless steel pipe & tube and other wares or sheet with rough surface.



Item no.	Contents
33 50 20 02	

CHROME-PLATED DIAMOND HOLE SAW

- Size 3-125mm
- For ceramic tiles and marble etc.
Package:2pcs in one blister



Item no.	Contents
33 50 20 03	2pc arbor

METRIC TAP

- DIN352



Item no.	Contents
33 60 00 01	M3
33 60 00 02	M4
33 60 00 03	M5
33 60 00 04	M6
33 60 00 05	M7
33 60 00 06	M8
33 60 00 07	M9
33 60 00 08	M10
33 60 00 09	M11
33 60 00 10	M12
33 60 00 11	M14
33 60 00 12	M16
33 60 00 13	M18
33 60 00 14	M20
33 60 00 15	M22
33 60 00 16	M24
33 60 00 17	M27
33 60 00 18	M30

CUTTING TOOLS



METRIC DIE

► DIN223



Item no. Contents

33 65 00 01	M3
33 65 00 02	M4
33 65 00 03	M5
33 65 00 04	M6
33 65 00 05	M7
33 65 00 06	M8
33 65 00 07	M9
33 65 00 08	M10
33 65 00 09	M11
33 65 00 10	M12
33 65 00 11	M14
33 65 00 12	M16
33 65 00 13	M18
33 65 00 14	M20
33 65 00 15	M22
33 65 00 16	M24
33 65 00 17	M27
33 65 00 18	M30

20 PCS METRIC TAP AND DIE SET

► Packed in plastic box



Item no. Contents

33 96 00 01	9 pcs dies size: 3x0.5 4x0.7 5x0.8 6X1.0 7X1.0 8X1.25 10X1.5 12X1.75 9 pcs taps size: 3x0.5 4x0.7 5x0.8 6X1.0 7X1.0 8X1.25 10X1.5 12X1.75 1 pc tap wrench 1 pc die handle 1"O.D
-------------	------------------------------------------------------------------------------------------------------------------------------------------------------------------------------------------------------

31 PCS METRIC TAP AND DIE SET

► Packed in plastic case



Item no. Contents

33 96 00 02	18 pcs 2pcs set tap M1 M1.1 M1.2 M1.4 M1.6 M1.8 M2.0 M2.2 M2.5 9 pcs dies M1 M1.1 M1.2 M1.4 M1.6M1.8 M2.0 M2.2 M2.5 1pc dies wrench 1pc dies lining 2pcs tap linings
-------------	----------------------------------------------------------------------------------------------------------------------------------------------------------------------------------------------

12 PCS TAP AND HEX DIE SET

► Packed in metal case



Item no. Contents

33 96 00 03	6 pcs NPT tap size: 1/8 1/4 3/8 1/2 3/4 1" 6 pcs NPT hex die size: 1/8 1/4 3/8 1/2 3/4 1"
-------------	----------------------------------------------------------------------------------------------------

20 PCS METRIC TAP & DIE SET

► Packed in metal case



Item no. Contents

33 96 00 04	9 pcs dies size: 3x0.5 4x0.7 5x0.8 6X1.0 7X1.0 8X1.25 10X1.5 12X1.75 9 pcs taps size: 3x0.5 4x0.7 5x0.8 6X1.0 7X1.0 8X1.25 10X1.5 12X1.75 1 pc tap wrench 1 pc die handle 1"O.D
-------------	------------------------------------------------------------------------------------------------------------------------------------------------------------------------------------------------------

40 PCS METRIC TAP AND DIE SET

► Packed in blow mould case



Item no. Contents

33 96 00 05	17 pcs taps size:3X0.5 3X0.6 4X0.7 4X0.75 5X0.8 5X0.9 6X1.0 6X.075 7X1.0 7X0.75 8X1.25 8X1.0 10X1.5 10X1.25 12X1.75 12X1.5 1/8-27NPT 17 pcs dies size:3X0.5 3X0.6 4X0.7 4X0.75 5X0.8 5X0.9 6X1.0 6X.075 7X1.0 7X0.75 8X1.25 8X1.0 10X1.5 10X1.25 12X1.75 12X1.5 1/8-27NPT 1 pc tape tap wrench 1/4" capacity 1 pc tap wrench 1 pc die handle 1"O.D 1pc screwdriver 1 pc screwpitch gauge 1 pc blow mould case
-------------	------------------------------------------------------------------------------------------------------------------------------------------------------------------------------------------------------------------------------------------------------------------------------------------------------------------------------------------------------------------------------------------------------------------------------------------------------

39 PCS METRIC TAP AND DIE SET

► Packed in blow mould case



Item no. Contents

33 96 00 06	21 pcs DIN 352 taps 3pcs set tap M3 M4 M5 M6 M8 M10 M12 7 pcs DIN223 25X9 dies M3 M4 M5 M6 M8 M10 M12 7 pcs DIN338 drills 2.5 3.3 4.2 5.0 6.8 8.5 10.2 1 pc DIN225 dies stock 25X9 1 pc DIN1814 taps wrench 1-1/2# 1 pc screw driver 1 pc screw pitch gauge 1 pc blow mould case
-------------	----------------------------------------------------------------------------------------------------------------------------------------------------------------------------------------------------------------------------------------------------------------------------------------------------------------

44 PCS METRIC TAP AND DIE SET

► Packed in metal case



Item no. Contents

33 96 00 07	21 pcs DIN352 3pcs taps: M3 M4 M5 M6 M8 M10 M12 7 pcs DIN 223B dies: M3 M4 M5 M6 M8 M10 M12 7 pcs DIN338 drills 2.5 3.3 4.2 5.0 6.8 8.5 10.2 5 pcs DIN225 dies 20X5 20X7 25X9 30X11 38X14 2 pcs DIN1814 taps wrench 1# 2# 1 pcs screw driver 1 pcs screw pitch gauge
-------------	----------------------------------------------------------------------------------------------------------------------------------------------------------------------------------------------------------------------------------------------------------------------------------------------------

46 PCS TAP AND HEX DIE SET

► Packed in metal case



Item no. Contents

33 96 00 08	20 pcs tap size:3X0.5 4X0.7 5X0.8 6X1.0 8X1.25 10X1.5 10X1.0 12X1.75 12X1.5 1/8-27NPT 20 pcs hex die size:3X0.5 4X0.7 5X0.8 6X1.0 8X1.25 10X1.5 10X1.0 12X1.75 12X1.5 1/8-27NPT 6-32UNC 8-32UNC 10-24UNC 10-32UNF 12-24UNC 1/4-20UNC 5/16-18UNC 3/8-16UNC 7/16-14UNC 1/2-13UNC 1pcs tap wrench 1 pc hex die handle 1"A.F 1 pc screwdriver 1 pc tape tap wrench 2 pcs screwpitch gauge
-------------	------------------------------------------------------------------------------------------------------------------------------------------------------------------------------------------------------------------------------------------------------------------------------------------------------------------------------------------------------------------------------------------------------------------------------

45 PCS TAP AND DIE SET

► Packed in blow mould case



Item no.	Contents
33 96 00 09	20pcs taps size:6x1.0 6x0.75 8x1.25 8x1.0 10x1.5 10x1.25 12x1.75 12x1.5 14x2.0 14x1.5 16x2.0 16x1.5 18x2.5 18x1.5 20x2.5 20x1.5 20pcs dies size:6x1.0 6x0.75 8x1.25 8x1.0 10x1.5 10x1.25 12x1.75 12x1.5 14x2.0 14x1.5 16x2.0 16x1.5 18x2.5 18x1.5 20x2.5 20x1.5 1pc die wrench 1pc tap wrench 1pc die handle 2"O.D 1pc screwdriver 1pc blow mould case

32 PCS TAP AND DIE SET

► Packed in metal case



Item no.	Contents
33 96 00 10	21pcs hand taps made of Alloy steel 7x round dies made of HSS: M3x0.5, M4x0.7, M5x0.8, M6x1.0, M8x1.25, M10x1.5M, 12x1.75 1pc Tap wrench M1-M12; 1pc die holder 1pc screwdriver 1pc metal case

24 PCS TAP AND DIE SET

► Packed in metal box



Item no.	Contents
33 96 00 11	10pcs Hex dies: M5x0.8, M5x0.9, M6x0.75, M6x1.0, M8x1.0, M8x1.25, M10x1.25, M10x1.5, M12x1.5, M12x1.75 1pc NPT die: 1/8-27 10pcs hand taps: M5x0.8, M5x0.9, M6x0.75, M6x1.0, M8x1.0, M8x1.25, M10x1.25, M10x1.5, M12x1.5, M12x1.75 1pc NPT die 1/8-27 1pc tap wrench 1pc die holder

33 PCS COMBINATION TAP AND DIE SET

► Packed in metal case with plastic tray



Item no.	Contents
33 90 00 12	7 pcs, Metric Round Dies: M3x0.5, M4x0.75, M5X0.8, M6X1.0, M8X1.25, M10X1.5, M12X1.75 5 pcs. UNF round dies: 1/4", 5/16", 3/8", 7/16", 1/2" 2 pcs. BSP round dies: 1/8", 1/4" 7 pcs, Hand taps: M3x0.5, M4x0.75, M5X0.8, M6X1.0, M8X1.25, M10X1.5, M12X1.75 5 pcs. UNF dies: 1/4", 5/16", 3/8", 7/16", 1/2" 2 pcs. BSP sizes: 1/8", 1/4" 1 pc. Tap wrench 1 pc. T-type tap wrench 1 pc. Handle for dies 1 pc. Screw-pitch gauge 1 pc. Screwdriver

110 PCS TAP AND DIE SET

► Packed in blow mould case



Item no.	Contents
33 90 00 13	35 circular screwing dies M2-M18 35 tape taps M2-M18 35 third taps M2-M18 2 tap wrenches M2-M12 M6-M20 2 die stocks M2-M11 M12-M18 1 toolholder M2-M6

TOOL BITS

► Hss. Rectangle



Item no.	Contents
33 70 00 02	

CENTER DRILL

► Hss



Item no.	Contents
33 99 00 29	0.8mm
33 99 00 30	1mm
33 99 00 31	1.25mm
33 99 00 32	1.6mm
33 99 00 33	2mm
33 99 00 34	2.5mm



ABRASIVE TOOLS

COMBINATION SHARPENING STONES

▶ Black silicon carbide/aluminum oxide

Item no.	Contents
35 10 00 01	150x50x25 (6")
35 10 00 02	200x50x25 (8")

SHARPENING STONES, OVAL SHAPE

▶ Black silicon carbide/aluminum oxide

Item no.	Contents
35 10 00 03	230x35x13 (9")

5PCS MOUNTED STONES SET

▶ Aluminum oxide
▶ ϕ 3x30mm shank 35000RPM
▶ ϕ 6x35mm shank 23000RPM

Item no.	Contents
35 90 00 01	

5PCS MOUNTED STONES SET

▶ Shank ϕ 3x27mm 35000RPM

Item no.	Contents
35 90 00 02	2pcs brown aluminum oxide 1pc pink aluminum oxide 2pcs white aluminum oxide

5PCS MOUNTED STONES SET

▶ Shank ϕ 6x27mm 23000RPM

Item no.	Contents
35 90 00 03	3pcs brown aluminum oxide 1pc pink aluminum oxide 1pc white aluminum oxide

7PCS MOUNTED STONES AND CUTTING DISCS SET

▶ Packed on black plastic holder

Item no.	Contents
35 90 00 05	3pcs Φ 3x35 pink aluminum oxide mounted stone 2pcs Φ 23 cutting disc 1pc Φ 3mm disc shank 1pc Φ 22 cutting disc

9PCS BRUSHES & POLISHING WHEEL SET

Item no.	Contents
35 90 00 06	2pcs pink aluminum oxide grinding wheel Φ 22X ϕ 2.8 Φ 20X ϕ 2.5 1pc Φ 3X35 wires polishing wheel 1pc Φ 3X15 black rubber polishing wheel 1pc Φ 3X35 black bristle brush 1pc Φ 3mm grinding wheel adaptor shank, 1pc Φ 3X35 wool polishing wheel 2pcs brown aluminum oxide round paper

12PCS MOUNTED STONES SET

▶ 12pcs Φ 3 X35 pink aluminum oxide stones
▶ Packed on plastic holder.

Item no.	Contents
35 90 00 07	

100PCS GRINDING AND CUTTING SET

Item no.	Contents
35 90 00 08	3pcs HSS cutters with 1/8" shank 2pcs diamond wheels points with 1/8" shank 10pcs grinding wheels 3pcs nylon brush 1/8" shank 1pc circular brush 3/4" 1pc cup brush 9/16" 1pc end brush 3/16" 3pcs stainless steel brush 1/8" shank 1pc circular brush 3/4" 1pc cup brush 9/16" 1pc end brush 3/16" 3pcs copper brush 1/8" shank 1pc circular brush 3/4" 1pc cup brush 9/16" 1pc end brush 3/16" 3pcs sanding disc wheels 1/8" 1pc drum sander with 1/8" shank, for 1/2"x1/2" sanding bands 1pc drum sander with 1/8" shank, for 1/4"x1/2" sanding bands 1pc screw mandrel for felt polishing accessories 10pcs 1-1/4" fiberglass reinforced cut-off wheels accessories 10pcs sanding bands: 5pcs 1/2"x1/2"+5pcs 1/4"x1/2" 10pcs felt polishing wheels: 5pcs 1"+5pcs 1/2" 1pc polishing compound 1pc dressing stone 40pcs cut-off wheels

100PCS GRINDING & CUTTING SET



Item no.	Contents
35 90 00 09	1pc end brush 3/16"
	22pcs sanding bands:
	11pcs 1/2"x1/2" + 11pcs 1/4"x1/2"
	1pc drum sander with 1/8" shank, for 1/2"x1/2" sanding bands
	1pc drum sander with 1/8" shank, for 1/4"x1/2" sanding bands
	1pc sanding disc wheels 1/8"
	1pc screw mandrel for felt polishing accessories
	2pcs collets
	1pc polishing compound
	1pc dressing stone
	10pcs 1-1/4" fiberglass reinforced cut-off wheels accessories
	10pcs felt polishing tip
	25pcs cut-off wheels
	11pcs grinding wheels with 1/8" shank
	6pcs HSS cutters
	3pcs nylon brush 1/8" shank
	1pc circular brush 3/4"
	1pc cup brush 9/16"
	1pc end brush 3/16"
	3pcs copper brush 1/8" shank
	1pc circular brush 3/4"
	1pc cup brush 9/16"

200PCS GRINDING AND POLISHING SET



Item no.	Contents
35 90 00 10	2pcs sanding drum:12.7mm, 6.35mm
	2pcs shanks
	2pcs high speed steel router bits
	5pcs diamond grinding bits
	3pcs steel wire brush
	3pcs brass wire brush
	3pcs black nylon brush
	3pcs high speed steel drill: 1.6mm, 2.3mm, 3.2mm
	30pcs pink cutting disc: 24X0.8mm, packed in plastic tube.
	30pcs black cutting disc: 24X0.6mm, packed in plastic tube.
	10pcs mesh abrasive cloth: 32X1.2mm
	10pcs sanding band:12.7mm, brown color.
	10 pcs sanding band:6.35mm, brown color.
	6pcs wool polishing wheel:25.4X6.4mm
	7pcs wool polishing wheel:13.0X6.4mm
	8pcs wool polishing tip:10X20mm
	1pc sanding cream tube
	1pc green grinding stone:10X10X20mm
	36pcs abrasive paper, packed in plastic box .
	6pcs pink grinding disc:20X3.3mm
	6pcs green grinding disc:20X3.3mm

200PCS GRINDING AND POLISHING SET

▶ PACKED IN ALUBOX WITH WINDOW



Item no.	Contents
35 90 00 11	3 pcs. diamond bit (1/8" shank)
	2 pcs.high speed cutter (1/8" shank)
	1 pc. screw mandrel (1/8" shank)
	1 set screw mandrel (1/8" shank)
	1 pc. 1/2" drum sander (1/8" shank)
	1 pc.1/4" drum sander (1/8" shank)
	8 pcs.1/2" coarse sanding band (1/2"x1/2")
	8 pcs. 1/4" coarse sanding band (1/4"x1/2")
	26 pcs. 15/16" cut-off wheel(23.8*06*2mm)
	1 pc. grinding stone (25.4*10mm)
	5 pcs. 1" felt polishing wheel (25.4*2mm)
	5 pcs. 1/4" felt polishing wheel (1/2"x5*2mm)
	5 pcs. felt polishing tip (9.6*21*2mm)
	10 pcs.wheels (31*1.2*2mm)
	3 pcs. carton steel brush(1/8" shank)
	3 pcs. bristle brush (1/8" shank)
	1 pc. polishing compound
	4 pcs. silicone oxide grinding stone (1/8" shank)
	4 pcs. silicone carbide grinding stone (1/8" shank)
	2 pcs.collet (1/8"+3/32")
	36 pcs.sand disc grit 180
	36 pcs.sand disc grit 220
	36 pcs.sand disc grit 240

ABRASIVE TOOLS

71PCS COMBINATION SET



Item no.	Contents
35 90 00 13	

50PCS COMBINATION SET



Item no.	Contents
35 90 00 14	

70PCS COMBINATION SET



Item no.	Contents
35 90 00 15	



ABRASIVE TOOLS

12PCS COMBINATION SET



Item no.	Contents
35 90 00 16	

13PCS POLISHING SET



Item no.	Contents
35 90 00 19	

17PCS CLEANING AND POLISHING SET



Item no.	Contents
35 90 00 22	

24PCS COMBINATION SET



Item no.	Contents
35 90 00 17	

40PCS MINI TOOLS ACCESSORY SET



Item no.	Contents
35 90 00 20	

16PCS SANDING DRUM SET



Item no.	Contents
35 90 00 23	

59PCS COMBINATION SET



Item no.	Contents
35 90 00 18	

22PCS BRUSH AND WHEEL SET



Item no.	Contents
35 90 00 21	

150PCS MINI GRINDER SET



Item no.	Contents
35 90 00 24	

249PCS MINI TOOLS ACCESSORY SET



Item no.	Contents
35 90 00 25	

300PCS MINI GRINDER SET



Item no.	Contents
35 90 00 26	

HIGH SPEED GRINDING DISC

▶ 40m/s



Item no.	Contents
35 10 40 01	125x16x16mm
35 10 40 02	150x20x16mm

DRILL SHARPENING TOOLS SET

▶ Nylon material cup with 16 holes for fixing drills



Item no.	Contents
35 80 40 01	3.6-4-4.3-4.6-5-5.3-5.6-6-6.5-7-7.5-8-8.5-9-9.8-10mm

DRY ABRASIVE PAPER

▶ Grit No.:24#-240#
▶ Dry abrasive paper takes glue and synthetic resin as bond, garnet, glass
▶ Brown aluminium oxide or white aluminium oxide as abrasive which are coated on paper backing
▶ It's suitable for sanding and polishing bamboo or woodware.



Item no.	Contents
35 20 30 01	230x280mm

WATER PROOF ABRASIVE PAPER

▶ Grit No.:60#-1000#
▶ Waterproof abrasive paper consists of waterproof treated kraft paper backing upon which a film of synthetic resin holds and supports a coating of brown aluminium oxide or silicon carbide
▶ It is suitable for sanding and polishing automobile, furniture, leather, housing of electrical household appliance and mechanical components
▶ It features good finish and no dust pollution

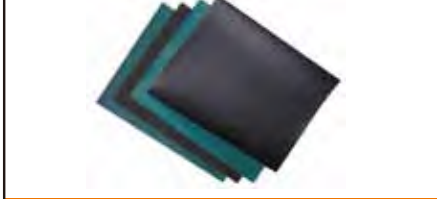

Item no.	Contents
35 20 30 02	230x280mm

DRY ALUMINIUM OXIDE CLOTH

▶ Grit No.:24#-400#
▶ Dry aluminium oxide cloth is made of artificial or natural abrasives coated on the cloth backing with glue and synthetic resin
▶ It is ideal for sanding and polishing metal, ceramics, rubber, wood, leather & glass



Item no.	Contents
35 20 30 03	230x280mm

ALUMINIUM OXIDE CLOTH

▶ Brit No.:36#-240#
▶ Aluminium oxide cloth is made of artificial or natural abrasives coated on the cloth backing with glue and synthetic resin. It is ideal for sanding and polishing metal, ceramics, rubber, wood, leather & glass



Item no.	Contents
35 20 30 04	230x280mm

TRIANGLE VELCRO ABRASIVE DISC

▶ Material:brown aluminium oxide/silicon carbide
▶ Grit No.:40#-400#



Item no.	Contents
35 20 30 05	93mm
35 20 30 06	95mm
35 20 30 07	105mm

RECTANGLE VELCRO ABRASIVE DISC

▶ Material:brown aluminium oxide/silicon carbide
▶ Grit No.:40#-400#



Item no.	Contents
35 20 30 08	80x166
35 20 30 09	93x178
35 20 30 10	93x785
35 20 30 11	93x230
35 20 30 12	115x115
35 20 30 13	115x140
35 20 30 14	115x230
35 20 30 15	115x280



VELCRO ABRASIVE DISC

- ▶ Material: brown aluminum oxide/silicon carbide
- ▶ Grit No.: 40#-403#

Item no.	Contents
35 20 30 16	125mm
35 20 30 17	180mm

VULCANIZED FIBRE DISCS

- ▶ Material: brown aluminum oxide/silicon carbide
- ▶ Grit No.: 40#-400#

Item no.	Contents
35 20 30 18	125mm
35 20 30 19	180mm

FLAP WHEEL WITH SHANK

- ▶ Brown aluminum oxide
- ▶ 80# shank with zinc plated
- ▶ Shank diameter: 6mm
- ▶ Out size: 40 mm

Item no.	Contents
35 99 00 01	40x20mm
35 99 00 02	50x20mm
35 99 00 03	60x40mm



SANDING BELT

- ▶ Material: brown aluminum oxide/silicon carbide
- ▶ Grit No.: 40#-400#

Item no.	Contents
35 20 30 22	6x51
35 20 30 23	40x303
35 20 30 24	60x400
35 20 30 25	65x410
35 20 30 26	75x457
35 20 30 27	75x610
35 20 30 28	100x533
35 20 30 29	100x610
35 20 30 30	105x620
35 20 30 31	1110x620

ZIRCONIUM ALUMINUM OXIDE FLAP DISC

- ▶ Rotation: 80M/S
- ▶ Material: brown aluminum oxide/ZIRCONIUM ALUMINUM OXIDE
- ▶ Grit No.: 24#-400#

Item no.	Contents
35 99 00 04	100
35 99 00 05	115
35 99 00 06	125

SANDING BLOCK

- ▶ Aluminum oxide/silicone carbide

Item no.	Contents
35 80 00 01	100x25x25
35 80 00 02	100x70x25
35 80 00 03	120x95x10
35 80 00 04	120x95x25

HAND FILE

- ▶ Bastard, Second and Smooth Cut

Item no.	Contents
35 30 00 01	4"
35 30 00 02	6"
35 30 00 03	8"
35 30 00 04	10"
35 30 00 05	12"
35 30 00 06	14"

HAND FILE

- ▶ Bastard, Second and Smooth Cut

Item no.	Contents
35 30 00 07	4"
35 30 00 08	6"
35 30 00 09	8"
35 30 00 10	10"
35 30 00 11	12"
35 30 00 12	14"

HALF ROUND FILE

- ▶ Bastard, Second and Smooth Cut

Item no.	Contents
35 30 00 13	4"
35 30 00 14	6"
35 30 00 15	8"
35 30 00 16	10"
35 30 00 17	12"
35 30 00 18	14"

ROUND FILE

► Bastard, Second and Smooth Cut



Item no. Contents

35 30 00 19	4"
35 30 00 20	6"
35 30 00 21	8"
35 30 00 22	10"
35 30 00 23	12"
35 30 00 24	14"

TRIANGULAR FILE

► Bastard, Second and Smooth Cut



Item no. Contents

35 30 00 25	4"
35 30 00 26	6"
35 30 00 27	8"
35 30 00 28	10"
35 30 00 29	12"
35 30 00 30	14"

SQUARE FILE

► Bastard, Second and Smooth Cut



Item no. Contents

35 30 00 31	4"
35 30 00 32	6"
35 30 00 33	8"
35 30 00 34	10"
35 30 00 35	12"
35 30 00 36	14"



HALF ROUND WOOD RASP

► Bastard, Second and Smooth Cut



Item no. Contents

35 30 20 01	4"
35 30 20 02	6"
35 30 20 03	8"
35 30 20 04	10"
35 30 20 05	12"
35 30 20 06	14"

ROUND WOOD RASP

► Bastard, Second and Smooth Cut



Item no. Contents

35 30 20 07	4"
35 30 20 08	6"
35 30 20 09	8"
35 30 20 10	10"
35 30 20 11	12"
35 30 20 12	14"

FLAT WOOD RASP

► Bastard, Second and Smooth Cut



Item no. Contents

35 30 20 13	4"
35 30 20 14	6"
35 30 20 15	8"
35 30 20 16	10"
35 30 20 17	12"
35 30 20 18	14"

CHAINSAW FILES



Item no. Contents

35 30 00 37	Dia 4.0x200mm
35 30 00 38	Dia 4.8x200mm
35 30 00 39	Dia 5.6x200mm

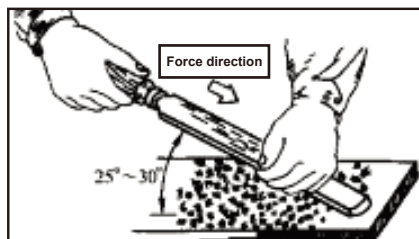

MILL FILES



Item no. Contents

35 30 00 40	8"
35 30 00 41	10"
35 30 00 42	12"
35 30 00 43	14"

DOUBLE HOLES ALUMINUM SHEET FILES



Item no. Contents

35 30 00 47	10"
35 30 00 48	12"
35 30 00 49	14"
35 30 00 50	16"

TUNGSTEN CARBIDE FILES

► Plastic handle



Item no. Contents

35 30 00 55	
-------------	--

3PCS WOOD RASP SET

- #45 carbon steel
- Wood handle
- Pouch packing

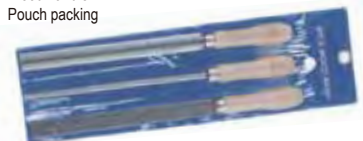

Item no. Contents

35 93 00 01	1pc flat wood rasp
	1pc round wood rasp
	1pc half round wood raps

4PCS FILES SET

- T12 carbon steel
- Second cutter
- HRC58-63
- Pouch packing
- Plastic handle



Item no. Contents

35 93 00 02	1pc round files
	1pc three square files
	1pc square files
	1pc flat files



ABRASIVE TOOLS

3PCS WOOD RASP SET

- ▶ #45 carbon steel
- ▶ 2 colors plastic handle
- ▶ Tie color card packing



Item no.	Contents
35 93 00 03	1pc flat wood rasp 1pc round wood rasp 1pc half round wood rap

3PCS FILES SET

- ▶ T12 carbon steel
- ▶ Second cutter
- ▶ HRC58-63
- ▶ 2 colors plastic handle
- ▶ Plastic holder packing



Item no.	Contents
35 93 00 04	1pc round files 1pc flat files 1pc half round files

3PCS WOOD RASP SET

- ▶ #45 carbon steel
- ▶ 2 colors plastic handle
- ▶ Half double blister card packing



Item no.	Contents
35 93 00 05	1pc flat wood rasp 1pc round wood rasp 1pc half round wood rasp

5PCS FILES SET

- ▶ T12 carbon steel
- ▶ Second cutter
- ▶ HRC58-63
- ▶ 2 colors plastic handle
- ▶ Double blister card packing



Item no.	Contents
35 93 00 06	half round files round files three triangular files square files flat files

8PCS FILES + RASP SET

- ▶ TUV/GS-Approval
- ▶ Finest quality hardened steel with rust resistant finishing
- ▶ Packed in blister card



Item no.	Contents
35 93 00 08	1 pc 2 Component TPR plastic handle; 1 pc 8 round file; 1 pc 8 flat file; 1 pc 8 half round file; 1 pc 8 triangular file; 1 pc 8 round wood rasp; 1 pc 8 half round wood rasp 1pc exchangeable Ergo handle, for safe and comfortable use

6PCS FILES + RASP SET

- ▶ TUV/GS-Approval
- ▶ Finest quality hardened steel with rust resistant finishing
- ▶ With ergonomic TPR handle for safe and comfortable use
- ▶ Packed transparent plastic case



Item no.	Contents
35 93 00 09	1 pc 8 round file; 1 pc 8 flat file; 1 pc 8 half round file; 1 pc 8 triangular file; 1 pc 8 square file; 1 pc 8 half round wood rasp

5PCS 8" FILES SET

- ▶ T12 carbon steel
- ▶ Second cutter
- ▶ HRC62-63
- ▶ 2 colors plastic handle
- ▶ Color box packing



Item no.	Contents
35 93 00 10	half round files round files triangular files square files & flat files

10 PCS NEEDLE FILE SET

- ▶ Forged and hardened teeth
- ▶ In PVC pouch



Item no.	Contents
35 20 30 11	6mmx160mm

10 PCS NEEDLE FILE SET

- ▶ Dipped handle
- ▶ PVC pouch packing



Item no.	Contents
35 20 30 12	flat files flat pointed files half round files round files triangular files square files

6 PCS NEEDLE FILE SET

- ▶ Forged and hardened teeth
- ▶ With wooden handle
- ▶ In PVC pouch



Item no.	Contents
35 20 30 13	5x180mm

5PCS NEEDLE FILE SET

- ▶ Forged and hardened teeth
- ▶ With plastic handle
- ▶ In PVC pouch
- ▶ 3*140/4*160/5*180mm



Item no.	Contents
35 20 30 14	5x180mm

6 PCS NEEDLE FILE SET

- ▶ 140mm long
- ▶ Made from high tool steel
- ▶ Hardened and tempered
- ▶ With 2 components TPR soft handle for comfortable use
- ▶ Packed in transparent plastic box.



Item no.	Contents
35 93 00 15	hand file, half round file, three square file, square file, round file, warding file

10 PCS RIFFLE FILES SET

- ▶ Carbon steel
- ▶ Forged & hardened teeth
- ▶ With dipped handle
- ▶ PVC pouch packing



Item no.	Contents
35 93 00 16	

10 PCS RIFFLE FILES SET

- ▶ Carbon steel
- ▶ Forged & hardened teeth
- ▶ Without handle
- ▶ PVC pouch packing



Item no.	Contents
35 93 00 17	5mmx180mm

DOUBLE EDGES FILES

- ▶ T12, carbon steel hardened
- ▶ wood handle



Item no.	Contents
35 30 60 01	3"
35 30 60 02	4"
35 30 60 03	6"

5PCS NEEDLE FILE SET

- ▶ Forged and hardened teeth
- ▶ With 2 colors plastic handle
- ▶ In PVC pouch
- ▶ Size:140mm
- ▶ Grit:#120/#150/#180/#300



Item no.	Contents
35 93 00 18	

NEEDLE FILE SET

- ▶ With dipped handle
- ▶ In PVC pouch
- ▶ Grit:#120/#150/#180/#300



Item no.	Contents
35 93 00 19	5pcs
	10pcs

5PCS RIFFLE DIAMOND FILES SET

- ▶ Grit No.:120/150/180/240
- ▶ Dipped handle
- ▶ In PVC pouch
- ▶ Grit:#120/#150/#180/#300



Item no.	Contents
35 93 00 20	5x180mm

DIAMOND MOUNTED POINT SET

- ▶ Packed in plastic box
- ▶ Total length:45mm
- ▶ Shank diameter:3/32", 1/8", 3.0mm
- ▶ Grit:#120/#150/#200



Item no.	Contents
35 90 00 12	10pcs
35 90 00 13	20pcs
35 90 00 14	25pcs
35 90 00 15	30pcs

4PCS DIAMOND MOUNTED POINT SET

- ▶ Contents: 3pcs diamond mounted points, 1pc holder
- ▶ In sliding card
- ▶ Grit:#180/#300/#600



Item no.	Contents
35 90 00 16	

MINI DIAMOND SHARPENER

- ▶ Contents: 1pcs diamond mounted points, 1pc holder
- ▶ In sliding card
- ▶ Grit:#180/#300/#600



Item no.	Contents
35 30 60 04	φ4x80x55mm
35 30 60 05	φ6.35x130x65mm

3PCS DIAMOND GRINDING SHEETS SET

- ▶ Bastard, Second and Smooth Cut
- ▶ Double blister card
- ▶ Grit:#300/#400/#600



Item no.	Contents
35 90 00 17	1"x3"/2"x6"

10PCS TUNGSTEN CARBIDE TILES

- ▶ 10PCS Packed in plastic box
- ▶ Total length:38mm/56mm/65mm
- ▶ Shank diameter:3/32", 1/8", 3.0mm



Item no.	Contents
35 90 00 18	1"x3"/2"x6"





5PCS ROTARY RASP SET

- ▶ Carbon steel with heat treatment
- ▶ Black finish

Item no.	Contents
35 90 00 19	2pcs column 2pcs taper 1pcs ball

UNIVERSAL BRUSH

- ▶ Steel wire
- ▶ With plastic handle

Item no.	Contents
35 40 20 01	250mm

BOW SHAPE UNIVERSAL BRUSH

- ▶ Steel wire
- ▶ With plastic handle

Item no.	Contents
35 40 20 02	250mm

LONG HANDLE UNIVERSAL BRUSH

- ▶ Steel wire
- ▶ With plastic handle

Item no.	Contents
35 40 20 03	250mm



WIRE BRUSH

- ▶ Straight wire/wavy wire
- ▶ Steel wire/brass wire/stainless wire/Zn coated wire
- ▶ Wooden handle

Item no.	Contents
35 40 20 04	2x16
35 40 20 05	3x16
35 40 20 06	4x16
35 40 20 07	5x16
35 40 20 08	6x16
35 40 20 09	4x11
35 40 20 10	4x15

WIRE BRUSH VIOLIN SHAPE

- ▶ Straight wire
- ▶ Steel wire/brass wire/stainless wire/Zn coated wire
- ▶ Wooden handle

Item no.	Contents
35 40 20 11	180x70

WIRE BRUSH SQUARE SHAPE

- ▶ Straight wire
- ▶ Steel wire/brass wire/stainless wire/Zn coated wire
- ▶ Wooden handle
- ▶ With wood shank

Item no.	Contents
35 40 20 12	165X60
35 40 20 13	180X60

WIRE BRUSH

- ▶ Straight wire
- ▶ Steel wire/brass wire/stainless wire/Zn coated wire
- ▶ Plastic handle

Item no.	Contents
35 40 20 14	250mm
35 40 20 15	335mm

WIRE BRUSH

- ▶ Straight wire
- ▶ Steel wire/brass wire/stainless wire/Zn coated wire/nylon wire
- ▶ Plastic handle

Item no.	Contents
35 40 20 16	165mm

WIRE BRUSH

- ▶ Straight wire
- ▶ Steel wire/brass wire/stainless wire/Zn coated wire/nylon wire
- ▶ Plastic handle

Item no.	Contents
35 40 20 17	square files

WIRE BRUSH

- ▶ Straight wire
- ▶ Steel wire/brass wire/stainless wire/Zn coated wire/nylon wire
- ▶ Plastic handle

Item no.	Contents
35 40 20 18	5x180mm

3PCS WIRE BRUSH SET

- ▶ Straight wire
- ▶ Steel wire/brass wire/nylon wire, plastic handle 9"
- ▶ Sliding card packing

Item no.	Contents
35 40 20 20	5x180mm

6PCS WIRE BRUSH SET

- ▶ Straight wire
- ▶ Steel wire/brass wire/nylon wire
- ▶ Plastic handle, 7" and 9"
- ▶ Sliding card packing

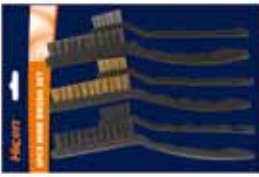

Item no.	Contents
35 40 20 21	

3PCS BRUSH SET

- ▶ PP wire/Stainless wire/Brass wire
- ▶ Bi-color plastic handles



Item no.	Contents
35 40 30 02	9"

11PCS SPRAY GUN CLEANING SET

- ▶ 5pcs tube brushes with bristle
- ▶ 6pcs nozzle cleaner
- ▶ Packed in sliding card



Item no.	Contents
35 40 20 20	

4PCS WIRE BRUSH SET

- ▶ Straight wire
- ▶ Steel wire/brass wire/nylon wire
- ▶ Plastic handle, 9"
- ▶ Sliding card packing



Item no.	Contents
35 40 20 22	

3PCS BRUSH SET

- ▶ PP wire/Stainless wire/Brass wire
- ▶ Bi-color plastic handles



Item no.	Contents
35 40 30 03	7"

3PCS WIRE BRUSH SET

- ▶ Steel wire/Brass wire
- ▶ Wooden handles
- ▶ Size: Length290mm,2/3/4/5/6row



Item no.	Contents
35 40 30 06	

3PCS WIRE BRUSH SET

- ▶ Straight wire
- ▶ Steel wire/brass wire/nylon wire
- ▶ Plastic handle, 7"
- ▶ Sliding card packing



Item no.	Contents
35 40 20 23	

3PCS BRUSH SET

- ▶ PP wire/Stainless wire/Brass wire
- ▶ Bi-color plastic handles



Item no.	Contents
35 40 30 04	Row: 3x7

5PCS BRUSH SET

- ▶ Bi-color plastic handles
- ▶ Packed in double blister



Item no.	Contents
35 40 30 07	Size:260mm,4*16row;345mm,3*19row;290mm,4*11scRow 2pcs PP bristle brushes Sie:180mm,3*10row; 185mm,5*11row

3PCS BRUSH SET

- ▶ PP wire/Stainless wire/Brass wire
- ▶ Bi-color plastic handles



Item no.	Contents
35 40 30 01	Row: 3x13

5PCS UNIVERSAL BRUSH SET

- ▶ Include: 1pc ceiling brush with plastic handle,
- ▶ 1pc handle brush, 1pc plastic roller, 1pc knife, 1pc sponge Packed in double blister



Item no.	Contents
35 40 30 05	

WIRE BRUSH

- ▶ Black steel
- ▶ Bi-color plastic handle



Item no.	Contents
35 40 30 08	165mm,4x18row



ABRASIVE TOOLS

WIRE BRUSH

- ▶ Black steel
- ▶ Bi-color plastic handle



Item no.	Contents
35 40 30 09	10"

2PCS WIRE BRUSH SET

- ▶ Black steel
- ▶ Plastic handle



Item no.	Contents
35 40 30 13	9x20row,18x7mm 6x19row,17x4.5mm

CIRCULAR BRUSH

- ▶ Flat shape, crimped steel wire with brass plated, with shank $\phi 40$ 4500rpm
- ▶ With 1/4"30mm shank/ with 1/4"25mm hexagon quick release adaptor



Item no.	Contents
35 40 00 01	$\phi 50$ x4500rpm
35 40 00 02	$\phi 63$ x4500rpm
35 40 00 03	$\phi 75$ x4500rpm
35 40 00 04	$\phi 100$ x4500rpm

WIRE BRUSH

- ▶ Black steel
- ▶ Iron shape
- ▶ Bi-color plastic handle



Item no.	Contents
35 40 30 10	

2PCS WIRE BRUSH SET

- ▶ Black steel
- ▶ Plastic handle



Item no.	Contents
35 40 30 14	3x17row,365mm 3x17row,345mm

CIRCULAR BRUSH

- ▶ Flat shape, crimped steel wire with brass plated



Item no.	Contents
35 40 00 05	$\phi 50$ x3/8"x4500RPM
35 40 00 06	$\phi 63$ x3/8"x4500RPM
35 40 00 07	$\phi 75$ x1/2"x4500RPM
35 40 00 08	$\phi 100$ x1/2"x4500RPM
35 40 00 09	$\phi 125$ x5/8-1/2"x3750RPM with PE adjustable ring
35 40 00 10	$\phi 150$ x5/8-1/2"x3750RPM with PE adjustable ring
35 40 00 11	$\phi 180$ x5/8-1/2"x3750RPM with PE adjustable ring

WIRE BRUSH

- ▶ Black steel
- ▶ Bi-color plastic handle



Item no.	Contents
35 40 30 11	180x65mm

HAND SCRUB BRUSH WITH MAGNET

- ▶ Material: PP+nylon
- ▶ With magnet



Item no.	Contents
35 40 30 15	125mm

WHEEL BRUSH

- ▶ flat shape, twisted knotted steel wire, with shank
- ▶ with 1/4"30mm shank



Item no.	Contents
35 40 00 12	$\Phi 75$ x2000RPM
35 40 00 13	$\Phi 100$ x16x12500RPM

WIRE BRUSH

- ▶ Black steel
- ▶ OX horn shape
- ▶ Bi-color plastic handle



Item no.	Contents
35 40 30 12	320mm,4x14row

6PCS BRUSH SET

- ▶ Plastic handle



Item no.	Contents
35 40 30 16	3pcs mini wire brushes: Steel wire/brass wire/nylon wire 2pcs handle wire brush: PP wire/nylon wire 1pc round brush: Nylon wire



WHEEL BRUSH

- ▶ flat shape, twisted knotted steel wire,



Item no.	Contents
35 45 00 14	Φ75*12.7*2000RPM
35 45 00 15	Φ100*16*12500RPM
35 45 00 16	Φ115*22.2*12500RPM
35 45 00 17	Φ125*22.2*10000RPM
35 45 00 18	Φ150*22.2*9000RPM
35 45 00 19	Φ180*22.2*9000RPM
35 45 00 20	Φ200*22.2*8500RPM

ABRASIVE WHEEL BRUSH

- ▶ Crimped filaments, with shank
- ▶ With 1/4**30mm shank/ with 1/4**25mm hexagon quick release adaptor



Item no.	Contents
35 45 00 21	φ50x4500rpm
35 45 00 22	φ60x4500rpm
35 45 00 23	φ75x4500rpm
35 45 00 24	φ100x4500rpm

ABRASIVE WHEEL BRUSH

- ▶ Crimped filaments



Item no.	Contents
35 45 00 25	Φ75x1/2"x4500RPM
35 45 00 26	Φ100x1/2"x4500RPM
35 45 00 27	Φ125x5/8-1/2"x3750RPM
35 45 00 28	Φ150x5/8-1/2"x3750RPM

CUP BRUSH

- ▶ Crimped wire, steel wire with brass plated, with shank
- ▶ With 1/4**30mm shank/ with 1/4**25mm hexagon quick release adaptor



Item no.	Contents
35 45 20 01	φ50mm/4500rpm
35 45 20 02	φ63mm/4500rpm
35 45 20 03	φ75mm/4500rpm
35 45 20 04	φ80mm/4500rpm

ABRASIVE CUP BRUSH

- ▶ Nylon filaments, with shank
- ▶ With 1/4**30mm shank/ with 1/4**25mm hexagon quick release adaptor



Item no.	Contents
35 45 20 05	φ50mm/4500rpm
35 45 20 06	φ75mm/4500rpm

CUP BRUSH

- ▶ Crimped wire, 0.3mm steel wire with brass plated, with M14X2 nut



Item no.	Contents
35 45 20 07	Φ65mm/12500rpm
35 45 20 08	Φ75mm/12500rpm
35 45 20 09	Φ85mm/8500rpm
35 45 20 10	Φ100mm/8500rpm
35 45 20 11	Φ125mm/6500rpm
35 45 20 12	Φ150mm/4500rpm

CUP BRUSH

- ▶ Twisted steel wire, with M14X2 nut



Item no.	Contents
35 45 20 13	Φ65mm/12500rpm
35 45 20 14	Φ75mm/11000rpm
35 45 20 15	Φ85mm/8500rpm
35 45 20 16	Φ100mm/8500rpm
35 45 20 17	Φ125mm/6500rpm

BEVEL BRUSH

- ▶ Crimped wire, 0.3mm steel wire with brass plated, with M14X2 nut



Item no.	Contents
35 45 20 18	Φ100mm/12500rpm
35 45 20 19	Φ115mm/12500rpm
35 45 20 20	Φ125mm/10000rpm

BEVEL BRUSH

- ▶ Twisted wire, with M14X2 nut



Item no.	Contents
35 45 20 21	Φ100mm/12500rpm
35 45 20 22	Φ115mm/12500rpm
35 45 20 23	Φ125mm/10000rpm



PENCIL BRUSH

- ▶ Crimped steel wire with brass plated, with shank
- ▶ With 1/4"×30mm shank/ with 1/4"×25mm hexagon quick release adaptor



Item no.	Contents
35 45 60 01	Φ17mm/4500rpm
35 45 60 02	Φ25mm/4500rpm
35 45 60 03	Φ28mm/4500rpm
35 45 60 04	Φ30mm/4500rpm

PENCIL BRUSH

- ▶ Crimped steel wire, with shank



Item no.	Contents
35 45 60 05	Φ12mm/4500rpm
35 45 60 06	Φ17mm/4500rpm
35 45 60 07	Φ25mm/4500rpm
35 45 60 08	Φ28mm/4500rpm
35 45 60 09	Φ30mm/4500rpm

ABRASIVE PENCIL BRUSH

- ▶ Nylon filaments, with shank



Item no.	Contents
35 45 60 10	Φ22mm/4500rpm
35 45 60 11	Φ25mm/4500rpm

TUBE BRUSH

- ▶ Crimped steel wire with brass plated, with shank



Item no.	Contents
35 40 40 01	Φ28mm/4500rpm

3PCS MINI WHEEL WIRE BRUSHES SET

- ▶ Flat shape & pencil shape
- ▶ Double blister card



Item no.	Contents
35 94 00 01	Φ30mm/4500rpm

3PCS WIRE BRUSH SET



Item no.	Contents
35 94 00 02	Circular wire brush with shank
	Cup wire brush with shank
	Pencil wire brush with shank

8PCS WIRE BRUSH SET

- ▶ Packed in skin card



Item no.	Contents
35 94 00 04	5pcs circular wire brushes
	3pcs adaptors

WOOL FELT POLISHING BONNETS



Item no.	Contents
35 50 00 01	Φ100
35 50 00 02	Φ115
35 50 00 03	Φ125
35 50 00 04	Φ150
35 50 00 05	Φ180
35 50 00 06	Φ230

TOWELING AND NON-WOVEN POLISHING BONNETS



Item no.	Contents
35 50 00 07	Φ100
35 50 00 08	Φ115
35 50 00 09	Φ125
35 50 00 10	Φ150
35 50 00 11	Φ180
35 50 00 12	Φ230

BUFFING WHEEL

- ▶ Material: 10 layers cotton clothes



Item no.	Contents
35 50 20 01	Φ80/ Φ6x25mm with shank
35 50 20 02	Φ100x20mm
35 50 20 03	Φ120x20mm
35 50 20 04	Φ150x20mm



BUFFING WHEEL



Item no.	Contents
35 50 20 05	White buffing wheel Φ150mm
35 50 20 06	Yellow buffing wheel Φ150mm

WOOL FELT POLISHING WHEEL



Item no.	Contents
35 50 20 07	75*13x4500RPM with 1/4" shank
35 50 20 08	100x13x4500RPM with 1/4" shank
35 50 20 09	115x13x4500RPM with 1/4" shank
35 50 20 10	125x13x3750RPM with 1/4" shank
35 50 20 11	150x16x3750RPM with 1/4" shank
35 50 20 12	178x16x3000RPM with 22.2mm hole
35 50 20 13	200x20x2500RPM with 22.2mm hole

BUFFING WHEEL



Item no.	Contents
35 50 20 14	Column buffing wheel: 1.5"/2.5"/3.5"
35 50 20 15	Taper buffing wheel: 2"/3"/4"
35 50 20 16	Round buffing wheel: 2"/2.5"/3"

PP BACKING PAD



Item no.	Contents
35 50 20 17	Φ115mm
35 50 20 18	Φ125mm
35 50 20 19	Φ150mm
35 50 20 20	Φ180mm

RUBBER BACKING PAD



Item no.	Contents
35 50 20 21	Φ115mm
35 50 20 22	Φ180mm

RUBBER BACKING PAD WITH SHANK



Item no.	Contents
35 50 20 23	Φ125mm
35 50 20 24	Φ180mm

RUBBER BACKING PAD WITH VELCRO



Item no.	Contents
35 50 20 25	Φ100mm
35 50 20 26	Φ125mm
35 50 20 27	Φ180mm

VELCRO WHEEL

▶ White wool felt, red Velcro, 6mm thickness



Item no.	Contents
35 50 20 28	Φ125mm

SPONGE PAD

▶ With M14*2 inner thread and with 8mm adaptor shank



Item no.	Contents
35 50 20 29	Φ125mm
35 50 20 30	Φ180mm

SPONGE PAD

▶ Back with felt



Item no.	Contents
35 50 20 31	Φ115mm
35 50 20 32	Φ125mm
35 50 20 33	Φ150mm
35 50 20 34	Φ180mm
35 50 20 35	Φ230mm

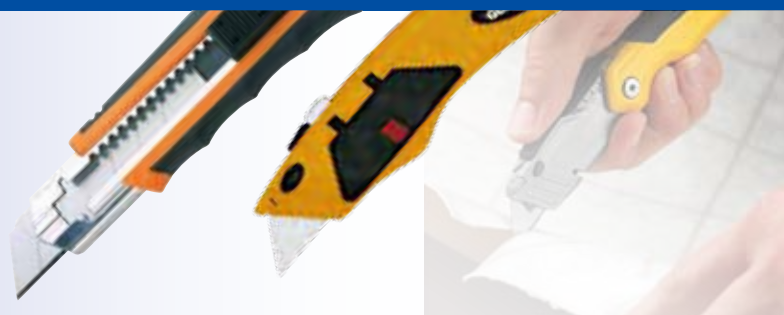

MULTI-PURPOSE KNIFE

- ▶ ABS plastic body
- ▶ With a 9mm high carbon steel blade



Item no.	Contents
43 10 00 01	9mm

MULTI-PURPOSE KNIFE

- ▶ ABS plastic body,TPR coated
- ▶ With a 9mm carbon steel blade
- ▶ Metal sleeve inside give better stability and safety



Item no.	Contents
43 10 00 05	9mm

MULTI-PURPOSE KNIFE

- ▶ Metal body
- ▶ With a 9mm high carbon steel blade



Item no.	Contents
43 10 00 09	9mm

MULTI-PURPOSE KNIFE

- ▶ ABS plastic body
- ▶ With a 9mm high carbon steel blade
- ▶ With pocket clip chrome plated



Item no.	Contents
43 10 00 02	9mm

MULTI-PURPOSE KNIFE

- ▶ Professional quality
- ▶ ABS plastic body,rubber coated
- ▶ With 8 pcs 9mm auto-loading blades



Item no.	Contents
43 10 00 06	9mm

MULTI-PURPOSE KNIFE

- ▶ ABS plastic body
- ▶ With a 18mm high carbon steel blade



Item no.	Contents
43 10 00 10	18mm

MULTI-PURPOSE KNIFE

- ▶ ABS plastic body
- ▶ With a 9mm high carbon steel blade
- ▶ Metal sleeve inside give better stability and safety



Item no.	Contents
43 10 00 03	9mm

MULTI-PURPOSE KNIFE

- ▶ Heavy duty style,
- ▶ Zinc-casting body
- ▶ With a 9mm high carbon steel blade



Item no.	Contents
43 10 00 07	9mm

MULTI-PURPOSE KNIFE

- ▶ ABS plastic body
- ▶ With a 18mm high carbon steel blade



Item no.	Contents
43 10 00 11	18mm

MULTI-PURPOSE KNIFE

- ▶ ABS plastic body,TPR coated
- ▶ With a 9mm high carbon steel blade
- ▶ Metal sleeve inside give better stability and safety



Item no.	Contents
43 10 00 04	9mm

MULTI-PURPOSE KNIFE

- ▶ Metal body
- ▶ With a 9mm high carbon steel blade



Item no.	Contents
43 10 00 08	9mm

MULTI-PURPOSE KNIFE

- ▶ ABS plastic body
- ▶ With a 18mm high carbon steel blade
- ▶ Metal sleeve inside give better stability and safety



Item no.	Contents
43 10 00 12	18mm

MULTI-PURPOSE KNIFE

- ▶ ABS plastic body
- ▶ With a 18mm high carbon steel blade
- ▶ Metal sleeve inside give better stability and safety



Item no.	Contents
43 10 00 13	18mm

MULTI-PURPOSE KNIFE

- ▶ Professional quality
- ▶ ABS plastic body, rubber coated
- ▶ With 8 pcs 18mm auto-loading blades
- ▶ With safety lock at the head



Item no.	Contents
43 10 00 18	18mm

MULTI-PURPOSE KNIFE

- ▶ Professional quality
- ▶ ABS plastic body, rubber coated
- ▶ With 3 pcs 25mm auto-loading blades



Item no.	Contents
43 10 00 23	25mm

MULTI-PURPOSE KNIFE

- ▶ ABS plastic body, rubber coated
- ▶ With a 18mm high carbon steel blade
- ▶ Metal sleeve inside give better stability and safety



Item no.	Contents
43 10 00 14	18mm

MULTI-PURPOSE KNIFE

- ▶ Professional quality
- ▶ Aluminum body, ABS and TPR coated
- ▶ With 3 pcs 18mm auto-loading blades



Item no.	Contents
43 10 00 19	18mm

MULTI-PURPOSE KNIFE

- ▶ Aluminum alloy body
- ▶ With extra 5pcs 18mm blades



Item no.	Contents
43 10 10 01	9mm
43 10 10 02	18mm

MULTI-PURPOSE KNIFE

- ▶ ABS plastic body, rubber coated
- ▶ With a 18mm high carbon steel blade
- ▶ Metal sleeve inside give better stability and safety



Item no.	Contents
43 10 00 15	18mm

MULTI-PURPOSE KNIFE

- ▶ Professional quality
- ▶ ABS plastic body, rubber coated
- ▶ With 6 pcs 18mm auto-loading blades
- ▶ With safety lock at the head



Item no.	Contents
43 10 00 20	18mm

MULTI-PURPOSE KNIFE

- ▶ Aluminum alloy body with TPR
- ▶ With extra 5pcs 18mm blades



Item no.	Contents
43 10 10 03	9mm
43 10 10 04	18mm

MULTI-PURPOSE KNIFE

- ▶ Duty style,
- ▶ Zinc-casting body
- ▶ With a 18mm high carbon steel blade



Item no.	Contents
43 10 00 16	18mm

MULTI-PURPOSE KNIFE

- ▶ Heavy duty style
- ▶ With EXTRA 25mm width blade for thick cutting



Item no.	Contents
43 10 00 21	25mm

MULTI-PURPOSE KNIFE

- ▶ ABS+TPR body
- ▶ With 1pc 18mm blade



Item no.	Contents
43 10 10 05	9mm
43 10 10 06	18mm

MULTI-PURPOSE KNIFE

- ▶ Professional quality
- ▶ ABS plastic body, rubber coated
- ▶ With 6 pcs 18mm auto-loading blades
- ▶ With safety lock at the head



Item no.	Contents
43 10 00 17	18mm

MULTI-PURPOSE KNIFE

- ▶ Heavy duty style
- ▶ ABS plastic body, rubber coated
- ▶ With EXTRA 25mm width blade for thick cutting



Item no.	Contents
43 10 00 22	25mm



KNIVES

MULTI-PURPOSE KNIFE

- ▶ ABS+TPR body
- ▶ With 1pc blade



Item no.	Contents
43 10 10 07	9mm
43 10 10 08	18mm

MULTI-PURPOSE KNIFE

- ▶ ABS+TPR body
- ▶ With 1pc 18mm high carbon steel blade



Item no.	Contents
43 10 10 13	18mm

3 PCS MULTI-PURPOSE KNIFE SET

- ▶ Including one knife with 18 mm blade, and two knives with 9mm blades.



Item no.	Contents
43 90 00 02	

MULTI-PURPOSE KNIFE

- ▶ ABS+TPR body
- ▶ With 1pc 9mm blade



Item no.	Contents
43 10 10 09	9mm

MULTI-PURPOSE KNIFE

- ▶ ABS plastic body
- ▶ With 1pc 9mm high carbon steel blade



Item no.	Contents
43 10 10 14	9mm

5 PCS MULTI-PURPOSE KNIFE SET

- ▶ Including one knife with 18 mm blade, and two knives with 9mm blades
- ▶ ABS plastic body, rubber coated
- ▶ Including 10 pcs 18mm blade in a case and 10pcs 9mm blades in another case



Item no.	Contents
43 90 00 03	

MULTI-PURPOSE KNIFE

- ▶ ABS plastic body
- ▶ With 1pc 9mm blade



Item no.	Contents
43 10 10 10	9mm

MULTI-PURPOSE KNIFE

- ▶ ABS plastic body
- ▶ With 1pc 18mm high carbon steel blade



Item no.	Contents
43 10 10 15	18mm

5 PCS MULTI-PURPOSE KNIFE SET

- ▶ Including one knife with 18 mm blade, two knives with 9mm blades, a scraper and a utility knife



Item no.	Contents
43 90 00 04	

MULTI-PURPOSE KNIFE

- ▶ ABS plastic body
- ▶ With 1pc 18mm blade



Item no.	Contents
43 10 10 11	18mm

2 PCS MULTI-PURPOSE KNIFE SET

- ▶ Professional quality
- ▶ ABS plastic body, rubber coated
- ▶ Self-loading system for comfort use
- ▶ Large knife holds 3 pcs 18mm blades with 8 easy snap off sections
- ▶ Small knife holds 3 pcs 9mm blades with 13 easy snap off sections
- ▶ Packed in double blister



Item no.	Contents
43 90 00 01	

8 PCS MULTI-PURPOSE KNIFE SET

- ▶ Including one knife with 18 mm blade, three knives with 9mm blades, two scrapers, a mini knife and a utility knife



Item no.	Contents
43 90 00 05	

UTILITY KNIFE

- ▶ ABS plastic body
- ▶ With a 18mm high carbon steel blade



Item no.	Contents
43 10 00 24	

UTILITY KNIFE

- ▶ Heavy duty style
- ▶ Zinc alloy body with soft rubber
- ▶ Quick blade changing mechanism
- ▶ With 3pcs blades in handle



Item no.	Contents
43 10 00 29	

UTILITY KNIFE

- ▶ Heavy duty style
- ▶ Zinc alloy body
- ▶ Quick blade changing mechanism
- ▶ With 4pcs blades in handle



Item no.	Contents
43 10 00 34	

UTILITY KNIFE

- ▶ Zinc alloy body
- ▶ With a high carbon steel blade



Item no.	Contents
43 10 00 25	

UTILITY KNIFE WITH LIGHT

- ▶ Heavy duty style
- ▶ Zinc alloy body with soft rubber
- ▶ Quick blade changing mechanism
- ▶ With light for easy cutting in darkness



Item no.	Contents
43 10 00 30	

FOLDING LOCK-BACK UTILITY KNIFE

- ▶ Zinc alloy body with soft rubber
- ▶ Quick blade changing mechanism
- ▶ Complete with 5 pcs blades in plastic case
- ▶ with one cutlery grade stainless steel blade



Item no.	Contents
43 10 00 35	25mm

UTILITY KNIFE

- ▶ Zinc alloy body
- ▶ With a high carbon steel blade



Item no.	Contents
43 10 00 26	

UTILITY KNIFE

- ▶ Heavy duty style
- ▶ Zinc alloy body
- ▶ Quick blade changing mechanism



Item no.	Contents
43 10 00 31	

UTILITY KNIFE

- ▶ Aluminum body with belt clip
- ▶ Quick blade changing mechanism
- ▶ One-hand easy opening operation



Item no.	Contents
43 10 00 36	

UTILITY KNIFE

- ▶ Heavy duty style
- ▶ Zinc alloy body
- ▶ With carrying plastic protection shell



Item no.	Contents
43 10 00 27	

UTILITY KNIFE

- ▶ Heavy duty style
- ▶ Zinc alloy body
- ▶ Automatic self loading for the blades
- ▶ With 5 pcs spare blades



Item no.	Contents
43 10 00 32	

UTILITY KNIFE

- ▶ Stainless steel body, rosewood handle, with belt clip
- ▶ Quick blade changing mechanism
- ▶ With 5pcs SK5 blades



Item no.	Contents
43 10 00 37	

UTILITY KNIFE

- ▶ Heavy duty style
- ▶ Zinc alloy body with soft rubber
- ▶ Quick blade changing mechanism
- ▶ With 3pcs blades in handle



Item no.	Contents
43 10 00 28	

QUICK CHANGE UTILITY KNIFE

- ▶ Heavy duty style
- ▶ Zinc alloy body with soft rubber
- ▶ Quick blade changing mechanism
- ▶ With 3pcs blades in handle



Item no.	Contents
43 10 00 33	



KNIVES

UTILITY KNIFE

- ▶ Zinc alloy body with soft rubber
- ▶ Quick blade changing mechanism
- ▶ Complete with 5 pcs blades in plastic case



Item no.	Contents
43 10 00 38	

UTILITY KNIFE

- ▶ Zinc alloy body with ABS
- ▶ With 3pcs blades



Item no.	Contents
43 10 00 52	

UTILITY KNIFE

- ▶ Zinc alloy body with TPR
- ▶ With 1pc 19mm high carbon steel blade



Item no.	Contents
43 10 00 57	19mm

UTILITY KNIFE

- ▶ Aluminum body with belt clip
- ▶ Quick blade changing mechanism
- ▶ One-hand easy opening operation
- ▶ Includes 10 pcs. Spare blades, one 4"/100mm knife and one 6"/150mm knife



Item no.	Contents
43 10 00 39	

UTILITY KNIFE

- ▶ Zinc alloy head, aluminum handle
- ▶ Quick blade changing mechanism



Item no.	Contents
43 10 00 53	19mm

UTILITY KNIFE

- ▶ Zinc alloy body
- ▶ With 1pc 19mm high carbon steel blade



Item no.	Contents
43 10 00 58	19mm

UTILITY KNIFE

- ▶ Zinc alloy body
- ▶ Quick blade changing mechanism
- ▶ With 3pcs 19mm blades



Item no.	Contents
43 10 00 50	19mm

UTILITY KNIFE

- ▶ Aluminum alloy body with ABS+TPR
- ▶ With 3pcs blades



Item no.	Contents
43 10 00 54	19mm

UTILITY KNIFE

- ▶ Zinc alloy body
- ▶ With 1pc 19mm high carbon steel blade



Item no.	Contents
43 10 00 59	19mm

UTILITY KNIFE

- ▶ Zinc alloy head, with aluminum handle
- ▶ Quick blade changing mechanism



Item no.	Contents
43 10 00 51	

UTILITY KNIFE

- ▶ Zinc alloy body
- ▶ With 1pc 19mm blade



Item no.	Contents
43 10 00 55	19mm

UTILITY KNIFE

- ▶ Zinc alloy body
- ▶ With 1pc 19mm high carbon steel blade



Item no.	Contents
43 10 00 60	19mm

UTILITY KNIFE

Zinc alloy body with TPR
With 1pc 19mm high carbon steel blade



Item no.	Contents
43 10 00 56	19mm

6 PCS UTILITY KNIFE SET

- ▶ one multi-purpose knife with 18mm blade
- ▶ one heavy duty utility knife
- ▶ one light duty utility knife
- ▶ 5pcs 18mm blades in one case
- ▶ 10 pcs utility knife blades in two cases



Item no.	Contents
43 90 00 06	

HOOK CUTTER

- ▶ Plastic handle
- ▶ Blade can draw back



Item no.	Contents
43 10 00 40	

CARPET CUTTER

- ▶ ABS plastic body
- ▶ With a high carbon steel blade



Item no.	Contents
43 10 00 41	

WALLPAPER CUTTER

- ▶ ABS plastic body
- ▶ With a 18mm high carbon steel blade



Item no.	Contents
43 10 00 42	



ROTARY CUTTER

- ▶ Great for medium to heavy duty projects
- ▶ Ergonomic scalloped design
- ▶ Comfortable handle and dual-action safety lock
- ▶ Perfect for scrapbooking, card making, crafts, unique edging on quilts etc.



Item no.	Contents
43 10 00 43	

3 PCS ROTARY CUTTER SET

- ▶ 1pc rotary cutter
- ▶ 1 pc multi-purpose knife with 18mm blade
- ▶ 1pc plastic scraper



Item no.	Contents
43 90 00 07	

CARPET KNIFE

- ▶ ABS+TPR body
- ▶ Great for medium to heavy duty project



Item no.	Contents
43 90 10 01	

PLASTIC CUTTER

- ▶ ABS plastic handle



Item no.	Contents
43 90 10 02	

SCRAPER

- ▶ ABS plastic body
- ▶ With a high carbon steel blade



Item no.	Contents
43 10 40 01	

SCRAPER

- ▶ ABS plastic body
- ▶ With a high carbon steel blade



Item no.	Contents
43 10 40 02	

SCRAPER

- ▶ ABS plastic body, dipped handle
- ▶ With a high carbon steel blade



Item no.	Contents
43 10 40 03	25mm

SCRAPER

- ▶ ABS plastic body
- ▶ With a high carbon steel blade



Item no.	Contents
43 10 40 04	

SCRAPER

- ▶ Metal body, nickel plated
- ▶ With a high carbon steel blade



Item no.	Contents
43 10 40 05	

TELESCOPIC SCRAPER

- ▶ Aluminum head
- ▶ Tubular handle, with plastic grip
- ▶ Adjustable length from 1M to 1.9M



Item no.	Contents
43 10 40 06	

SCRAPER

- ▶ Tungsten carbide blade
- ▶ Aluminum alloy body
- ▶ Plastic handle



Item no.	Contents
43 10 40 07	

SCRAPER

- ▶ Aluminum head
- ▶ Tubular handle, with dipped grip



Item no.	Contents
43 90 10 09	

WALLPAPER CUTTER

- ▶ Aluminum body
- ▶ Length 58.5 cm
- ▶ With stainless blade
- ▶ For pasting or cutting wall paper



Item no.	Contents
43 10 10 38	

SCRAPER

- ▶ Aluminum alloy body
- ▶ ABS+TPR handle



Item no.	Contents
43 90 10 02	25mm
43 90 10 03	52mm
43 90 10 04	65mm

SCRAPER

- ▶ Zinc alloy head
- ▶ Tubular handle, with TPR grip



Item no.	Contents
43 90 10 10	

KNIFE BLADE

- ▶ Packed in transparent plastic case
- ▶ 10 pcs 9mm blades



Item no.	Contents
43 10 50 01	9mm 10pcs
43 10 50 02	18mm 10pcs
43 10 50 03	25mm 10pcs

SCRAPER

- ▶ Aluminum alloy head
- ▶ Tubular flexible handle, with TPR grip



Item no.	Contents
43 90 10 11	

UTILITY KNIFE BLADE



Item no.	Contents
43 10 50 04	60x19mm

KNIVES

SCRAPER

- ▶ Aluminum alloy body
- ▶ Nylon handle



Item no.	Contents
43 90 10 05	25mm
43 90 10 06	52mm
43 90 10 07	65mm

MINI SCRAPER

- ▶ ABS+TPR body
- ▶ With high carbon steel blade



Item no.	Contents
43 90 10 12	

SCRAPER'S BLADE

- ▶ High carbon steel blade

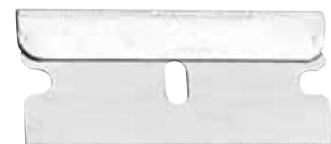

Item no.	Contents
43 10 50 05	39.5x19.5mm

SCRAPER

- ▶ ABS body
- ▶ With high carbon steel blade



Item no.	Contents
43 90 10 08	19mm

MINI SCRAPER

- ▶ ABS+TPR body
- ▶ With high carbon steel blade



Item no.	Contents
43 90 10 13	

ROTARY CUTTER'S BLADE

- ▶ High carbon steel blade



Item no.	Contents
43 10 50 06	45/60mm

KNIFE BLADE

- ▶ ABS plastic box
- ▶ 50pcs/100pcs



Item no.	Contents
43 10 50 10	19mm

KNIFE BLADE

- ▶ Transparent plastic box
- ▶ 50pcs/100pcs



Item no.	Contents
43 10 50 11	19mm

KNIFE BLADE

- ▶ Transparent plastic box
- ▶ 50pcs/100pcs



Item no.	Contents
43 10 50 12	19mm

HORN BLADE

- ▶ Transparent plastic box
- ▶ 5pcs/10pcs



Item no.	Contents
43 10 50 13	19mm

HORN BLADE

- ▶ Transparent plastic box
- ▶ 5pcs/10pcs



Item no.	Contents
43 10 50 14	19mm

6 PCS HOBBY KNIFE SET

- ▶ One pc deluxe grip blade handle
- ▶ With 5pc blades



Item no.	Contents
43 90 00 08	

33 PCS HOBBY KNIFE SET

- ▶ Packed in a storage case



Item no.	Contents
43 90 00 09	4 pcs handles 24 pcs blades 2 pcs scratch awlblades 1 pc tweezers 1 pc plastic caliper 1 pc percision screwdriver

65 PCS HOBBY KNIFE SET

- ▶ Packed in a wooden case



Item no.	Contents
43 90 00 10	4 pcs handles 55 pcs blades 1 pc jewelers screwdriver 2 pairs of offset tweezers 1 pc iron ruler 1 pc block plane 1 pc block sander

16 PCS HOBBY KNIFE SET

- ▶ Packed in a plastic case



Item no.	Contents
43 90 00 11	3 pcs handles 13 pcs blades

26 PCS HOBBY KNIFE SET

- ▶ Packed in a wooden case



Item no.	Contents
43 90 00 12	4 pcs handles 21 pcs blades 1 pc tweezers

51 PCS HOBBY KNIFE SET



Item no.	Contents
43 90 00 13	7 pcs handles 42 pcs blades 1 pc mighty bond 1 pc block sander

29PC DELUXE HOBBY KNIFE KIT



Item no.	Contents
43 90 00 20	2pc rubber coated blades holders 1pc deluxe grip blade handle 24pc woodcarving blades With dual material storage case

33PC DELUXE HOBBY KNIFE KIT



Item no.	Contents
43 90 00 21	3pc rubber coated blades holders 1pc deluxe grip blade handle 24pc woodcarving blades 2pc scratch awl blades 1 pair of tweezers 1pc plastic caliper 1pc precision jeweler screwdriver with storage case

36PC DELUXE HOBBY KNIFE KIT



Item no.	Contents
43 90 00 22	2pc rubber coated blades holders 28pc woodcarving blades 2pc scratch awl blades 1 pair of tweezers 1pc plastic caliper 1pc precision jeweler screwdriver with storage case

CABLE KNIFE

- ▶ Stainless steel blades, curved
- ▶ With good quality wood handle



Item no.	Contents
43 30 00 01	8" /200mm

CABLE KNIFE

- ▶ Stainless steel blades, curved
- ▶ With good quality wood handle



Item no.	Contents
43 30 00 02	8" /200mm

CABLE KNIFE

- ▶ Stainless steel blades, curved
- ▶ With good quality wood handle



Item no.	Contents
43 30 00 03	8" /200mm

HUNTING KNIFE

- ▶ Stainless steel blade
- ▶ Soft rubber handle
- ▶ With a blade sheath



Item no.	Contents
43 40 00 01	100mm

HUNTING KNIFE

- ▶ Stainless steel blade
- ▶ Plastic handle
- ▶ With a blade sheath



Item no.	Contents
43 40 00 02	100mm

HUNTING KNIFE

- ▶ Stainless steel blade
- ▶ Including a protection cover with belt loop



Item no.	Contents
43 40 00 03	150mm

SURVIVAL KNIFE

- ▶ Stainless steel blade
- ▶ Including compass, fish hook grinding stone and fishing tackle



Item no.	Contents
43 40 00 04	

SURVIVAL KNIFE

- ▶ 8" stainless steel blade
- ▶ With fine wooden handle



Item no.	Contents
43 90 00 14	13"

FOLDING KNIFE

- ▶ The length of blade is 115mm; Wooden handle, Stainless steel blade.
- ▶ With operation lock.



Item no.	Contents
43 90 00 23	265mm

CABLE KNIFE

- ▶ Stainless steel blade, straight.
- ▶ With good quality wooden handle.



Item no.	Contents
43 90 00 24	185mm

FOLDING KNIFE

- ▶ The length of blade is 95mm;
- ▶ High quality stainless steel blade.
- ▶ Color painted steel handle.
- ▶ With securing pin.



Item no.	Contents
43 90 00 25	210mm

FOLDING KNIFE

- ▶ Length of blade is 72MM
- ▶ 420 Stainless steel blade, black finish S/S handle with clip.



Item no.	Contents
43 90 00 30	

MULTI-PURPOSE PLIER

- ▶ Made of stainless steel
- ▶ Foldable structure
- ▶ With 10 functions
- ▶ Plastic coated handle



Item no.	Contents
43 40 40 02	

FOLDING KNIFE

- ▶ The length of blade is 95mm
- ▶ 420 Stainless steel blade
- ▶ Black blade and Aluminum handle with clip.



Item no.	Contents
43 90 00 26	185mm

MULTI-USE KNIFE

- ▶ Stainless steel blade
- ▶ With 11 functions



Item no.	Contents
43 40 20 01	

MULTI-PURPOSE PLIER

- ▶ Made of stainless steel
- ▶ Foldable structure
- ▶ With 9 functions
- ▶ Including bits
- ▶ Packed in nylon bag



Item no.	Contents
43 40 40 03	

FOLDING KNIFE

- ▶ Length of blade is 70MM
- ▶ 420 Stainless steel blade,
- ▶ S/S handle with clip.



Item no.	Contents
43 90 00 27	170mm

MULTI-USE KNIFE

- ▶ Stainless steel blade
- ▶ With 14 functions
- ▶ Plastic coated handle



Item no.	Contents
43 40 20 02	

MULTI-PURPOSE PLIER

- ▶ Made of stainless steel
- ▶ Foldable structure
- ▶ With 8 functions
- ▶ Including bits
- ▶ Packed in nylon bag



Item no.	Contents
43 40 40 04	

FOLDING KNIFE

- ▶ Length of blade is 75MM
- ▶ 420 Stainless steel blade,
- ▶ Rubber handle with clip.



Item no.	Contents
43 90 00 28	175mm

MULTI-USE KNIFE

- ▶ Stainless steel blade
- ▶ With 17 functions
- ▶ Plastic coated handle
- ▶ With compass



Item no.	Contents
43 40 20 03	

FOLDING KNIFE

- ▶ Length of blade is 67MM
- ▶ 420 Stainless steel blade,
- ▶ Rubber handle with clip.



Item no.	Contents
43 90 00 29	160mm

MULTI-PURPOSE PLIER

- ▶ Foldable structure
- ▶ With 6 functions



Item no.	Contents
43 40 40 01	



KNIVES

MULTI-PURPOSE PLIER

- ▶ Made of stainless steel
- ▶ Foldable structure
- ▶ With 9 functions
- ▶ With fine wood on the handle
- ▶ Including bits
- ▶ Packed in nylon bag



Item no.	Contents
43 40 40 05	

MULTI-PURPOSE PLIER

- ▶ Stainless steel blade
- ▶ With 9 functions
- ▶ Anodized aluminum+ABS inlay handle



Item no.	Contents
43 40 40 08	153mm

MULTI-PURPOSE PLIER

- ▶ Stainless steel blade
- ▶ With 9 functions
- ▶ Anodized aluminum+ABS inlay handle



Item no.	Contents
43 40 40 11	145mm

MULTI-PURPOSE PLIER

- ▶ Made of stainless steel
- ▶ Foldable structure
- ▶ With 22 functions
- ▶ With soft rubber on the handle
- ▶ Including bits
- ▶ Packed in nylon bag



Item no.	Contents
43 40 40 06	

MULTI-PURPOSE PLIER

- ▶ Stainless steel blade
- ▶ With 9 functions
- ▶ Anodized aluminum+ABS inlay handle



Item no.	Contents
43 40 40 09	160mm

MULTI-PURPOSE PLIER

- ▶ Stainless steel blade
- ▶ With 9 functions
- ▶ Anodized aluminum+ABS inlay handle



Item no.	Contents
43 40 40 12	158mm

MULTI-PURPOSE PLIER

- ▶ Stainless steel blade
- ▶ With 9 functions
- ▶ aluminum handle



Item no.	Contents
43 40 40 07	160mm

MULTI-PURPOSE PLIER

- ▶ Stainless steel blade
- ▶ With 9 functions
- ▶ Anodized aluminum+ABS inlay handle
- ▶ Black finish



Item no.	Contents
43 40 40 10	160mm

MULTI-PURPOSE PLIER

- ▶ Stainless steel blade
- ▶ With 9 functions
- ▶ Anodized aluminum+ABS inlay handle
- ▶ Packed in nylon bag



Item no.	Contents
43 40 40 13	168mm

FRUIT KNIFE

- ▶ Foldable structure
- ▶ 12.5 cm closed
- ▶ Stainless steel blade
- ▶ Plastic handle



Item no.	Contents
43 60 20 01	212mm

CERAMIC FRUIT KNIFE

- ▶ Ceramic Blade
- ▶ Plastic handle



Item no.	Contents
43 60 20 02	3"
43 60 20 03	4"
43 60 20 04	5"
43 60 20 05	6"
43 60 20 06	7"

7 PCS KITCHEN KNIFE SET

- ▶ Professional quality stainless blades
- ▶ Triple-riveted plastic-handle
- ▶ With a cutting board



Item no.	Contents
43 90 00 15	

6 PCS KITCHEN KNIFE SET

- ▶ Professional quality stainless blades
- ▶ With fine wooden handle
- ▶ Including 5 pcs knives and one knife sharpener
- ▶ In a wooden holder



Item no.	Contents
43 90 00 16	

MACHETE

- ▶ Made of high carbon steel
- ▶ Heat treated and hardened



Item no.	Contents
43 50 00 01	250mm

MACHETE

- ▶ Made of high carbon steel
- ▶ Heat treated and hardened



Item no.	Contents
43 50 00 02	450mm

SCYTHE

- ▶ Made of high carbon steel
- ▶ Heat treated and hardened
- ▶ With tubular handle
- ▶ With plastic grip
- ▶ Total length 36cm



Item no.	Contents
43 50 20 01	180mm



SICKLE

- ▶ Made of high carbon steel
- ▶ Heat treated and hardened
- ▶ With fine wooden handle



Item no.	Contents
43 50 20 02	8"
43 50 20 03	10"
43 50 20 04	12"
43 50 20 05	14"
43 50 20 06	16"
43 50 20 07	18"
43 50 20 08	20"

HAND HAY CUTTER

- ▶ Steel holder
- ▶ With fine wooden handle



Item no.	Contents
43 50 40 01	Blade 320mm

PIPE CUTTER

- ▶ Round Aluminum body
- ▶ Blade material Gcr15/HRC58-62°
- ▶ High carbon steel wheel
- ▶ Zinc plated



Item no.	Contents
43 70 00 01	12-22mm

MINI PIPE CUTTER

- ▶ Aluminium die-casting body
- ▶ Bearing steel blade



Item no.	Contents
43 70 00 02	3-22mm

PIPE CUTTER

- ▶ Heavy duty style
- ▶ Aluminium die-casting body
- ▶ Bearing steel blade
- ▶ Tubular handle with plastic grip



Item no.	Contents
43 70 00 06	12-50mm

PVC PIPE CUTTER

- ▶ Aluminium die-casting body
- ▶ 65Mn blade
- ▶ Soft dipped handles



Item no.	Contents
43 70 00 10	3-42mm

PIPE CUTTER

- ▶ Aluminium die-casting body
- ▶ Bearing steel blade



Item no.	Contents
43 70 00 03	3-28mm

PVC PIPE CUTTER

- ▶ Aluminium die-casting body
- ▶ 65Mn blade
- ▶ Soft dipped handles.



Item no.	Contents
43 70 00 07	3-42mm

PVC PIPE CUTTER

- ▶ Aluminium die-casting body
- ▶ 65Mn blade



Item no.	Contents
43 70 00 11	3-35mm

PIPE CUTTER

- ▶ Aluminium die-casting body
- ▶ Bearing steel blade



Item no.	Contents
43 70 00 04	3-32mm

PVC PIPE CUTTER

- ▶ Aluminum alloy body
- ▶ High quality tool steel blade, hardened and tempered
- ▶ Expert quality ratchet mechanism for easier and improve a cutting efficiency



Item no.	Contents
43 70 00 08	

PIPE CUTTER

- ▶ Aluminium die-casting body
- ▶ Bearing steel blade



Item no.	Contents
43 70 00 05	6-127mm

PVC PIPE CUTTER

- ▶ Aluminum alloy body
- ▶ High quality tool steel blade, hardened and tempered
- ▶ Expert quality ratchet mechanism for easier and improve a cutting efficiency



Item no.	Contents
43 70 00 09	26-42mm

5IN1 PIPE CUTTING SHEARS

- ▶ Interchangeable variable angle multi-cut heads
- ▶ with opening safety-catch
- ▶ Five sections:
 - ▶ mitre section: variable angle:45, 60, 75, 90, 105, 120
 - ▶ cylindrical section for hose:5/8" 3/4"
 - ▶ cylindrical section for PVC pipe: 1"
 - ▶ square section: up to 1-1/4"
 - ▶ flat section: 2-1/4"



Item no.	Contents
43 90 00 17	



GLASS CUTTER

- ▶ Six wheel turret head cutter
- ▶ With wooden handle



Item no.	Contents
43 70 40 01	

GLASS CUTTER

- ▶ YG6X alloy head,
- ▶ Metal tube handle lacquered



Item no.	Contents
43 70 40 05	

OPENER

- ▶ ABS plastic body
- ▶ With a high carbon steel blade



Item no.	Contents
43 99 00 03	

GLASS CUTTER

- ▶ Steel swivel head, brass shank
- ▶ Wooden handle.



Item no.	Contents
43 70 40 02	

GLASS CUTTER

- ▶ Cutting DIA: 60cm
- ▶ Bakelite handle
- ▶ Brass ruler with scales
- ▶ With a suction cup



Item no.	Contents
43 70 40 06	

SHARPENER

- ▶ Tungsten carbide steel sharpening blades
- ▶ Can sharpen serrated knives scissors etc



Item no.	Contents
43 99 00 04	

GLASS CUTTER

- ▶ YG6X alloy head,
- ▶ Metal handle lacquered



Item no.	Contents
43 70 40 03	

SCRATCH PEN

- ▶ High carbon steel body
- ▶ Chrome plated
- ▶ YG6X alloy head



Item no.	Contents
43 99 00 01	

GLASS CUTTER

- ▶ YG6X alloy head,
- ▶ Transparent plastic tube handle, with brass end



Item no.	Contents
43 70 40 04	

OPENER

- ▶ ABS plastic body
- ▶ With a 18mm high carbon steel blade



Item no.	Contents
43 99 00 02	

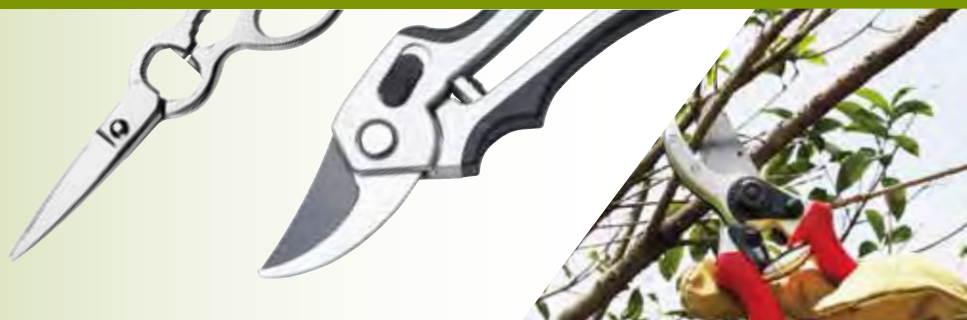

AVIATION SNIPS

- ▶ Forged head
- ▶ With plastic grip



Item no.	Contents
45 10 00 01	10" Left
45 10 00 02	10" Straight
45 10 00 03	10" Right

HEAVY DUTY AVIATION SNIPS

- ▶ Forged head
- ▶ With 2 component soft handle



Item no.	Contents
45 10 00 04	10" Left
45 10 00 05	10" Straight
45 10 00 06	10" Right

GERMANY TYPE AVIATION SNIPS

- ▶ Forged head
- ▶ With plastic grip



Item no.	Contents
45 10 00 07	10" Left
45 10 00 08	10" Straight
45 10 00 09	10" Right

HEAVY DUTY GERMANY STYLE AVIATION SNIPS

- ▶ Forged head
- ▶ With plastic grip



Item no.	Contents
45 10 00 10	10" Left
45 10 00 11	10" Right

MULTI-PURPOSE AVIATION SNIPS

- ▶ Forged head
- ▶ Chrome-plated
- ▶ With plastic grip



Item no.	Contents
45 10 00 13	9.5"

LABORSAVING AVIATION SNIPS

- ▶ Forged head
- ▶ With 2 component soft handle



Item no.	Contents
45 10 00 14	11"

GOLDSMITH SCISSORS

- ▶ High carbon steel drop forged entirely
- ▶ Lacquered handle



Item no.	Contents
45 10 20 05	7"

TINMAN'S SNIPS

- ▶ High carbon steel drop forged entirely
- ▶ Spring design for easier cutting
- ▶ Dipped handle



Item no.	Contents
45 10 20 01	9" Left
45 10 20 02	9" Straight
45 10 20 03	9" Right

GERMANY STYLE TINMAN'S SNIPS

- ▶ High carbon steel drop forged entirely
- ▶ Spring design for easier cutting
- ▶ Dipped handle



Item no.	Contents
45 10 20 04	12"

GERMANY STYLE TINMAN'S SNIPS

- ▶ Forged steel
- ▶ Polished head
- ▶ Lacquered handle



Item no.	Contents
45 10 20 06	8"
45 10 20 07	10"
45 10 20 08	12"
45 10 20 09	14"

BRITISH TYPE TINMAN'S SNIPS

- ▶ Forged steel
- ▶ Polished head
- ▶ Lacquered handle



Item no. Contents

45 10 20 10	8"
45 10 20 11	10"
45 10 20 12	12"
45 10 20 13	14"

RUSSIAN TYPE TINMAN'S SNIPS

- ▶ Drop forged steel
- ▶ black finish
- ▶ Dipped handle



Item no. Contents

45 10 20 14	
-------------	--

RUSSIAN TYPE TINMAN'S SNIPS (CURVE NOSE)

- ▶ Drop forged steel
- ▶ black finish
- ▶ Dipped handle



Item no. Contents

45 10 20 15	10"
-------------	-----

FRENCH TYPE TINMAN'S SNIPS

- ▶ Drop forged steel
- ▶ Sand blasting finish
- ▶ Dipped handle



Item no. Contents

45 10 20 16	10"
-------------	-----

FRENCH TYPE TINMAN'S SNIPS (CURVE NOSE)

- ▶ Drop forged steel
- ▶ Sand blasting finish
- ▶ Dipped handle



Item no. Contents

45 10 20 17	11"
-------------	-----

FRENCH TYPE TINMAN'S SNIPS

- ▶ Forged blades
- ▶ Chrome-plated
- ▶ Bi-color plastic handle



Item no. Contents

45 10 20 18	
-------------	--

GERMAN TYPE LABORSAVING TINMAN'S SNIPS

- ▶ Forged steel
- ▶ Polished
- ▶ Bi-color dipped handle



Item no. Contents

45 10 20 19	8"
45 10 20 20	10"

AMERICAN TYPE TINMAN'S SNIPS

- ▶ Forged steel
- ▶ Polished
- ▶ Bi-color dipped handle



Item no. Contents

45 10 20 21	7"
45 10 20 22	8"
45 10 20 23	10"
45 10 20 24	12"
45 10 20 25	16"



KITCHEN SCISSORS

- ▶ Stainless steel blades
- ▶ Plastic handle



Item no. Contents

45 20 00 01	8"
-------------	----

KITCHEN SCISSORS

- ▶ Stainless steel blades
- ▶ Plastic handle



Item no. Contents

45 20 00 02	8"
-------------	----

KITCHEN SCISSORS

- ▶ Stainless steel blades
- ▶ Plastic handle



Item no. Contents

45 20 00 03	8"
-------------	----

KITCHEN SCISSORS

- ▶ Stainless steel



Item no. Contents

45 20 00 04	8"
-------------	----

CHICKEN SCISSORS

- ▶ Stainless steel



Item no. Contents

45 20 00 05	9.5"
-------------	------



TAILOR SHEARS

- ▶ Casting iron
- ▶ Polished



Item no.	Contents
45 20 20 01	10"

3 PCS TAILOR SHEARS

- ▶ Casting iron
- ▶ Polished
- ▶ Lacquered handle



Item no.	Contents
45 90 00 01	1pc 5" shears 1pc 7" shears 1pcs9" shears

SCHOOL SCISSORS

- ▶ Stainless steel blades
- ▶ With scale on the blades
- ▶ Plastic handle



Item no.	Contents
45 20 40 01	5.25"

SCHOOL SCISSORS

- ▶ Stainless steel blades
- ▶ Bi-color plastic handle



Item no.	Contents
45 20 40 02	5"

4 PCS HOUSEHOLD SCISSOR SET

- ▶ 1pc 4.5"
- ▶ 1pc 5.5"
- ▶ 1pc 8.5"
- ▶ 1pc 9.5"
- ▶ Stainless steel blades
- ▶ Bi-color handle



Item no.	Contents
45 90 00 02	4.5" 5.5" 8.5" 9.5"

PET SCISSOR

- ▶ Stainless steel blades
- ▶ Plastic handle



Item no.	Contents
45 99 00 01	

MULTI-PURPOSE PLIERS

- ▶ For cutting cable
- ▶ Wire netting
- ▶ Aluminum wares and leather
- ▶ Anti-impact grips designed to fit human body engineering for the comfort of holding
- ▶ Stainless steel blades delicate
- ▶ Sharp and after use so as to keep the blades sharp
- ▶ Handle material:PP+TPR
- ▶ Blade: sand blasting finishing



Item no.	Contents
45 20 80 01	7"
45 20 80 02	8"

ELECTRICIAN'S SCISSORS

- ▶ For cutting cable, wire netting, aluminum wares
- ▶ Anti-impact grips designed to fit human body engineering for the comfort of holding
- ▶ Stainless steel blades HRC52-54
- ▶ Handle material:PP+TPR
- ▶ Static resists



Item no.	Contents
45 20 80 03	5.5"

ELECTRICIAN'S SCISSORS

- ▶ For cutting cable, wire netting, aluminum wares
- ▶ Anti-impact grips designed to fit human body engineering for the comfort of holding
- ▶ Stainless steel blades HRC52-54
- ▶ Handle material:PP+TPR
- ▶ Static resists



Item no.	Contents
45 20 80 04	5.5"

ELECTRICIAN'S SCISSORS

- ▶ Stainless steel blades
- ▶ Plastic handle



Item no.	Contents
45 20 80 05	5.5"

STRAIGHT PRUNING SHEAR

- ▶ Forged steel
- ▶ Polished
- ▶ Bi-color dipped handle



Item no.	Contents
45 30 00 01	6"
45 30 00 03	8"

BENT PRUNING SHEAR

- ▶ Forged steel
- ▶ Polished
- ▶ Dipped handle



Item no.	Contents
45 30 00 05	6"
45 30 00 07	8"

BYPASS PATTERN PRUNING

- ▶ Forged steel
- ▶ Nickel plated
- ▶ Dipped handle



Item no.	Contents
45 30 00 09	8"

PRUNING SHEARS

- ▶ Forged steel
- ▶ Polished
- ▶ Dipped handle



Item no.	Contents
45 30 00 11	8"

PRUNING SHEARS

- ▶ Forged steel
- ▶ Polished
- ▶ Dipped handle



Item no.	Contents
45 30 00 13	8"

BYPASS PATTERN PRUNING SHEAR

- ▶ Forged steel blades
- ▶ Polished & powder coated
- ▶ Plastic handle



Item no.	Contents
45 30 00 15	180mm/7"
45 30 00 16	200mm/8"
45 30 00 17	220mm/9"

BYPASS PATTERN PRUNING SHEAR

- ▶ Forged steel
- ▶ Polished & powder coated



Item no.	Contents
45 30 00 18	200mm/8"
45 30 00 19	220mm/9"

ORANGE SHEAR

- ▶ Forged steel blades
- ▶ Polished
- ▶ Dipped handle



Item no.	Contents
45 30 00 20	5"

ORANGE SHEAR

- ▶ Forged steel blades
- ▶ Polished
- ▶ Dipped handle



Item no.	Contents
45 30 00 21	4.5"-5.25"

BYPASS PATTERN PRUNING SHEAR

- ▶ Forged steel blades
- ▶ Polished
- ▶ Wood covered handle



Item no.	Contents
45 30 00 22	8"

STRAIGHT PRUNING SHEAR

- ▶ Forged steel blades
- ▶ Polished
- ▶ Wood covered handle



Item no.	Contents
45 30 00 24	8"

BYPASS PRUNING SHEAR

- ▶ Forged steel blades
- ▶ Polished
- ▶ Wood covered handle



Item no.	Contents
45 30 00 25	8"

BYPASS PATTERN PRUNING SHEAR

- ▶ Forged steel blades
- ▶ Polished
- ▶ Bi-color plastic handle



Item no.	Contents
45 30 00 26	8"

BYPASS PATTERN PRUNING SHEAR

- ▶ A: Bypass pattern pruning shear; plastic handle with PVC non-slip part
- ▶ B: Anvil pattern pruning shear; plastic handle with PVC non-slip part



Item no.	Contents
45 30 00 27	A 8"
45 30 00 28	B 8"
45 30 00 29	A+B

BYPASS PATTERN PRUNING SHEAR

- ▶ A: Bypass pattern pruning shear; plastic handle with PVC non-slip part
- ▶ B: Anvil pattern pruning shear; plastic handle with PVC non-slip part



Item no.	Contents
45 30 00 30	8"
45 30 00 31	8"

STRAIGHT PRUNING SHEAR

- ▶ High carbon steel, chrome-plated blades
- ▶ ABS plastic handle
- ▶ 1/2" cutting capacity



Item no.	Contents
45 30 00 32	



SCISSORS

BYPASS PATTERN SHEAR

- ▶ High carbon steel, chrome-plated blades
- ▶ ABS plastic handle
- ▶ 1/2" cutting capacity



Item no.	Contents
45 30 00 33	

BYPASS PATTERN PRUNING SHEAR

- ▶ High carbon steel, polished
- ▶ Casting iron body
- ▶ 3/4" cutting capacity



Item no.	Contents
45 30 00 38	

ANVIL PATTERN PRUNING SHEAR

- ▶ Aluminum alloy body
- ▶ SK5 blade double sharpened;
- ▶ Ratchet mechanism for easier cutting
- ▶ 5/8" cutting capacity



Item no.	Contents
45 30 00 43	8"

BYPASS PATTERN PRUNING SHEAR

- ▶ High carbon steel, chrome-plated blades
- ▶ ABS plastic handle
- ▶ 1/2" cutting capacity



Item no.	Contents
45 30 00 34	

BYPASS PATTERN PRUNING SHEAR

- ▶ High carbon steel, chrome-plated blades
- ▶ Zinc-alloy handle with plastic layer
- ▶ 3/4" cutting capacity



Item no.	Contents
45 30 00 39	

STRAIGHT PRUNING SHEAR

- ▶ Hardened steel blade
- ▶ Zinc alloy handle, TPR covered



Item no.	Contents
45 30 00 44	6.5"

ANVIL PATTERN PRUNING SHEAR

- ▶ Aluminum alloy body
- ▶ Alloy steel blade hardened; Double sharpened
- ▶ Ratchet mechanism for easier cutting
- ▶ 5/8" cutting capacity



Item no.	Contents
45 30 00 35	

BYPASS PATTERN PRUNING SHEAR

- ▶ High carbon steel blades
- ▶ Soft plastic layer grips
- ▶ 3/4" cutting capacity



Item no.	Contents
45 30 00 40	

BYPASS PATTERN PRUNING SHEAR

- ▶ Hardened steel blade
- ▶ Zinc alloy handle, TPR covered



Item no.	Contents
45 30 00 45	6.5"

BYPASS PATTERN PRUNING SHEAR

- ▶ High carbon steel, exchangeable blades
- ▶ Aluminum handle with PVC dipped
- ▶ 5/8" cutting capacity



Item no.	Contents
45 30 00 36	

BYPASS PATTERN PRUNING SHEAR

- ▶ High carbon steel blades
- ▶ Polished steel handle with PVC dipped
- ▶ 1/2" cutting capacity



Item no.	Contents
45 30 00 41	

DROP FORGED BY-PASS ALUMINUM PRUNING SHEAR

- ▶ Aluminum body, whole-piece drop forged, with Oxidation treatment
- ▶ Top quality SK5 carbon steel blade
- ▶ Blade hardness HRC52-54
- ▶ Cutting capacity: 20mm



Item no.	Contents
45 30 00 46	8"

BYPASS PATTERN PRUNING SHEAR

- ▶ High carbon steel, exchangeable blades
- ▶ Aluminum handle with PVC dipped low friction rotatable handle
- ▶ 5/8" cutting capacity.



Item no.	Contents
45 30 00 37	

ANVIL PATTERN PRUNING SHEAR

- ▶ Zinc alloy anvil
- ▶ Soft plastic layer grips
- ▶ 3/4" cutting capacity



Item no.	Contents
45 30 00 42	



DROP FORGED BY-PASS ALUMINUM PRUNING SHEAR

- ▶ Aluminum body, whole-piece drop forged, with Oxidation treatment
- ▶ Top quality SK5 carbon steel blade
- ▶ Blade hardness HRC52-54
- ▶ Cutting capacity: 20mm



Item no.	Contents
45 30 00 47	8"

ANVIL PRUNING SHEAR

- ▶ High quality SK5 steel blade, hard chrome plated
- ▶ Strong and light-weight aluminum body
- ▶ Non-slip soft TPR grips
- ▶ Cutting capacity: 18mm



Item no.	Contents
45 30 00 51	8"

BY-PASS PRUNING SHEAR

- ▶ Upper blade: 4.0mm high carbon steel
- ▶ Lower blade: 4.0mm middle carbon steel, chrome plated
- ▶ Aluminum handles with TPR grips



Item no.	Contents
45 30 00 55	8"

DIE-CASTING ALUMINUM PRUNING SHEAR

- ▶ High quality carbon steel blade
- ▶ Cutting capacity: 16mm



Item no.	Contents
45 30 00 48	8"

ANVIL PRUNING SHEAR

- ▶ Upper blade: 4.0mm high carbon steel
- ▶ Lower blade: 4.0mm middle carbon steel, chrome plated
- ▶ Aluminum handles with TPR grips



Item no.	Contents
45 30 00 52	8"

BY-PASS PRUNING SHEAR

- ▶ Upper blade: 4.0mm high carbon steel
- ▶ Lower blade: 4.0mm middle carbon steel, chrome plated
- ▶ Aluminum handles with TPR grips



Item no.	Contents
45 30 00 56	8"

BY-PASS PRUNING SHEAR

- ▶ High quality SK5 steel blade, hard chrome plated
- ▶ Strong and light-weight aluminum body
- ▶ Non-slip soft TPR grips
- ▶ Cutting capacity: 18mm



Item no.	Contents
45 30 00 49	8"

BY-PASS PRUNING SHEAR

- ▶ Upper blade: 4.0mm high carbon steel
- ▶ Lower blade: 4.0mm middle carbon steel, chrome plated
- ▶ Aluminum handles with TPR grips



Item no.	Contents
45 30 00 53	8"

BUILT-IN RATCHET PRUNING SHEAR

- ▶ Ratchet design for saving effort
- ▶ High quality 65Mn or SK5 steel blade
- ▶ Die-casting aluminum body, lacquered surface
- ▶ Dipped handle grips
- ▶ Cutting capacity: 25mm



Item no.	Contents
45 30 00 57	8"

FLORAL PRUNING SHEAR

- ▶ High quality SK5 steel blade, hard chrome plated
- ▶ Strong and light-weight aluminum body
- ▶ Non-slip soft TPR grips
- ▶ Cutting capacity: 18mm



Item no.	Contents
45 30 00 50	8"

BY-PASS PRUNING SHEAR

- ▶ Upper blade: 4.0mm high carbon steel
- ▶ Lower blade: 4.0mm middle carbon steel, chrome plated
- ▶ Aluminum handles with TPR grips



Item no.	Contents
45 30 00 54	8"

DROP FORGED PRUNING SHEAR

- ▶ Top quality 55# carbon steel, whole-piece drop forged
- ▶ Heat treatment HRC52-54 on head
- ▶ Machine-polished blade, Powder coating handle
- ▶ Skidproof blade
- ▶ Cutting capacity: 16mm



Item no.	Contents
45 30 00 58	7"



DROP FORGED APPLE SHEAR

- ▶ Top quality 55# carbon steel
- ▶ Whole-piece drop forged, hardness HRC52-54
- ▶ Cutting capacity: 20mm



Item no.	Contents
45 30 00 59	8"

FRUIT SHEAR, CURVED BLADE

- ▶ Blade: 65Mn steel, heat treatment HRC52-54
- ▶ Handle: 45# carbon steel, heat treatment HRC35-40
- ▶ Teflon coated surface
- ▶ Available size: 6-1/2", 7"



Item no.	Contents
45 30 00 60	6-1/2"
45 30 00 61	7"

FRUIT SHEAR, STRAIGHT BLADE

- ▶ Blade: 65Mn steel, heat treatment HRC52-54
- ▶ Handle: 45# carbon steel, heat treatment HRC35-40
- ▶ Teflon coated surface
- ▶ Available size: 6-1/2", 7"



Item no.	Contents
45 30 00 62	6-1/2"
45 30 00 63	7"



GRASS SHEAR

- ▶ High carbon steel, blades
- ▶ 180°revolvable design
- ▶ Bi-color plastic handle
- ▶ 4-1/2" cutting length



Item no.	Contents
45 60 20 01	

GRASS SHEAR

- ▶ High carbon steel blades
- ▶ 90°revolvable design
- ▶ Plastic handle
- ▶ 4-1/2" cutting length



Item no.	Contents
45 60 20 02	

GRASS SHEAR

- ▶ High carbon steel blade
- ▶ Iron die casting handle, with PVC dipped
- ▶ 4-1/2" cutting length



Item no.	Contents
45 60 20 03	

ANVIL PATTERN LOPPERS

- ▶ High carbon steel blades
- ▶ Aluminum handle plastic + rubber grips
- ▶ Ratchet mechanism
- ▶ 1/4" cutting capacity



Item no.	Contents
45 60 20 04	24"-35"
45 60 20 05	21"-29"
45 60 20 06	21"-29" With fixed holes on the handle
45 60 20 07	19"

BYPASS PATTERN LOPPERS

- ▶ High carbon steel blades
- ▶ Aluminum handle plastic + rubber grips
- ▶ Ratchet mechanism
- ▶ 1/4" cutting capacity



Item no.	Contents
45 60 20 08	24" -31"
45 60 20 09	21" -29"
45 60 20 10	21" -29" With fixed holes on the handle
45 60 20 11	19"

HEDGE SHEAR

- ▶ 9" high carbon steel blades
- ▶ Aluminum handle, plastic + rubber grips
- ▶ Ratchet mechanism
- ▶ Shock absorbing bumper
- ▶ 26"-34" With fixed holes on the handle



Item no.	Contents
45 60 20 12	26"-34"
45 60 20 13	26"-34" with fixed holes on the handle

ANVIL PATTERN LOPPERS

- ▶ High carbon steel blades
- ▶ Aluminum handle, plastic + rubber grips
- ▶ Ratchet mechanism
- ▶ 1" cutting capacity



Item no.	Contents
45 60 20 14	19"



HEDGE SHEAR

- ▶ 10" blade curved cutting edges
- ▶ Strong light-weight handles
- ▶ 2 components comfortable grips
- ▶ Blades tension adjustor
- ▶ Shock absorbing bumper
- ▶ Overall length: 24"



Item no.	Contents
45 60 20 15	26"-35"
45 60 20 16	24"

HEDGE SHEAR

- ▶ 10" high carbon steel blades
- ▶ Curved cutting edge
- ▶ Telescopic steel tube handle, plastic grips



Item no.	Contents
45 60 20 20	26"-33"

ANVIL PATTERN LOPPERS

- ▶ High carbon steel blades
- ▶ Telescopic aluminum tube handle with plastic grips



Item no.	Contents
45 60 20 24	22-1/4"~29-1/2"

HEDGE SHEAR

- ▶ 10" high carbon coated blades
- ▶ Curved cutting edge
- ▶ Aluminum handle, plastic + rubber grips
- ▶ Blade tension adjustable
- ▶ Shock absorbing bumper



Item no.	Contents
45 60 20 17	25"

BYPASS PATTERN LOPPERS

- ▶ High carbon steel, blades
- ▶ Telescopic steel tube handle plastic grips
- ▶ Shock absorbing bumper
- ▶ 1-5/8" cutting capacity



Item no.	Contents
45 60 20 21	27"-41"

ANVIL PATTERN LOPPERS

- ▶ High carbon steel blades
- ▶ Wood handles with painted steel ferrules.



Item no.	Contents
45 60 20 25	29"

BYPASS PATTERN LOPPERS

- ▶ High carbon steel blades
- ▶ Telescopic steel tube handle, plastic grips
- ▶ Shock absorbing bumper
- ▶ 1-5/8" cutting capacity



Item no.	Contents
45 60 20 18	27"-41"

ANVIL PATTERN LOPPERS

- ▶ High carbon steel blades
- ▶ Zinc alloy anvil
- ▶ Telescopic steel tube handle plastic grips
- ▶ 2" cutting capacity



Item no.	Contents
45 60 20 22	27"-41"

BYPASS PATTERN LOPPERS

- ▶ High carbon steel blades
- ▶ Wood handles with painted steel ferrules.



Item no.	Contents
45 60 20 26	28"

ANVIL PATTERN LOPPERS

- ▶ High carbon steel blades
- ▶ Zinc alloy anvil
- ▶ Telescopic steel tube handle plastic grips
- ▶ 1-1/2" cutting capacity



Item no.	Contents
45 60 20 19	26"-40"

BYPASS PATTERN LOPPERS

- ▶ High carbon steel blades
- ▶ Chrome-plated anvil
- ▶ Ratchet mechanism
- ▶ Steel tube handle with PP/TPR grips



Item no.	Contents
45 60 20 23	26"

BYPASS PATTERN LOPPERS

- ▶ High carbon steel blades
- ▶ Wood handles with painted steel ferrules.



Item no.	Contents
45 60 20 27	21"



3 PCS GARDEN SCISSORS SET

- ▶ 1pc bypass pattern loppers
- ▶ 1pc hedge shears
- ▶ 1pc bypass pattern pruning shears
- ▶ High carbon steel blades
- ▶ Steel tube handle with plastic grips



Item no.	Contents
45 60 20 28	

HEDGE SHEARS

- ▶ Curved cutting edges.8" carbon steel blades
- ▶ Hardwood handles
- ▶ Shock absorbing bumper
- ▶ Overall length:21"



Item no.	Contents
45 60 20 31	21"

18-1/2" ANVIL LOPPING SHEARS

- ▶ Blade size: 3"*4.0mm
- ▶ Upper blade: middle carbon steel
- ▶ Lower blade: middle carbon steel, Plating
- ▶ Oval tubular Aluminum handles with PP/TPR grips



Item no.	Contents
45 60 20 08	18-1/2"

HEDGE SHEARS

- ▶ Curved cutting edges.8" carbon steel blades
- ▶ Blade tension adjustor:strong tube steel handles
- ▶ Non-slip plastic grips.
- ▶ Blacked blade finish
- ▶ Overall length:21"



Item no.	Contents
45 60 20 29	21"

HEDGE SHEARS

- ▶ Curved cutting edges.8" carbon steel blades
- ▶ Hardwood handles
- ▶ Overall length:19"



Item no.	Contents
45 60 20 32	19"

HEDGE SHEARS

- ▶ Curved cutting edges.8" carbon steel blades
- ▶ Blade tension adjustor
- ▶ Hardwood handles
- ▶ Shock absorbing bumper
- ▶ Overall length:21"



Item no.	Contents
45 60 20 30	21"

18-1/2"BY-PASS LOPPING SHEARS

- ▶ Blade size: 3"*4.0mm
- ▶ Upper blade: middle carbon steel
- ▶ Lower blade: middle carbon steel, Plating
- ▶ Oval tubular Aluminum handles with PP/TPR grips



Item no.	Contents
45 60 20 33	18-1/2"



SCISSORS



HIGH CARBON STEEL HAND HACKSAW BLADE



Item no.	Contents
47 10 00 01	300x12.7x0.62x14T
47 10 00 02	300x12.7x0.62x18T
47 10 00 03	300x12.7x0.62x24T
47 10 00 04	300x12.7x0.62x32T

FLEXIBLE HIGH CARBON STEEL HAND HACKSAW BLADE

Item no.	Contents
47 10 00 05	300x12.7x0.62x14T
47 10 00 06	300x12.7x0.62x18T
47 10 00 07	300x12.7x0.62x24T
47 10 00 08	300x12.7x0.62x32T

M2 BI-METAL HAND HACKSAW BLADE

Item no.	Contents
47 10 00 09	300x12.7x0.62x14T
47 10 00 10	300x12.7x0.62x18T
47 10 00 11	300x12.7x0.62x24T
47 10 00 12	300x12.7x0.62x32T

HIGH SPEED STEEL HACKSAW BLADE

Item no.	Contents
47 10 00 13	300x12.7x0.62x14T
47 10 00 14	300x12.7x0.62x18T
47 10 00 18	300x12.7x0.62x24T
47 10 00 16	300x12.7x0.62x32T

JUNIOR HACKSAW

- ▶ High carbon steel
- ▶ Black finish



Item no.	Contents
47 10 00 17	153x6x0.4x14T
47 10 00 18	153x6x0.4x18T
47 10 00 19	153x6x0.4x24T
47 10 00 20	153x6x0.4x32T

HSS/BI-METAL POWER HACKSAW BLADE

- ▶ Powder coating



Item no.	Contents
47 10 00 21	12"X1"X10T/14T
47 10 00 22	14"X1"X10T(14T)
47 10 00 23	14"X1-1/4"X6T/10T
47 10 00 24	16"X1-1/4"X6T/10T
47 10 00 25	17"(18")X1-1/4"X10T
47 10 00 26	21"X1-3/4"X6T

DOUBLE EDGES SAW BLADE

- ▶ Carbon steel material
- ▶ Teeth with heat treatment



Item no.	Contents
47 10 00 27	300mm

GARDEN SAW

- ▶ A STYLE Double-side grinding teeth
- ▶ High frequency hardened
- ▶ Material:65Mn/50Mn/T10/SK5



Item no.	Contents
47 10 20 01	12"
47 10 20 02	18"
47 10 20 03	21"
47 10 20 04	24"
47 10 20 05	30"
47 10 20 06	36"

GARDEN SAW

- ▶ B STYLE Double-side grinding teeth
- ▶ High frequency hardened
- ▶ Material:65Mn/50Mn/T10/SK5



Item no.	Contents
47 10 20 07	12"
47 10 20 08	18"
47 10 20 09	21"
47 10 20 10	24"
47 10 20 11	30"
47 10 20 12	36"

MITER SAW BLADE

- ▶ High Carbon steel
- ▶ Teeth with heat treatment
- ▶ Polished
- ▶ Teeth: 14T/18T/24T



Item no.	Contents
47 10 00 28	350mm
47 10 00 29	550mm
47 10 00 30	600mm

FRET SAW BLADE

- ▶ High carbon steel material T9/SK4
- ▶ Heat treatment
- ▶ Black finish



Item no.	Contents
47 10 40 01	130x0.6x0.26x22T
47 10 40 02	130x1.65x0.28x21T
47 10 40 03	130x0.7x0.3x20T
47 10 40 04	130x0.8x0.35x19T
47 10 40 05	130x0.85x0.35x18T
47 10 40 06	130x0.95x0.4x17T
47 10 40 07	130x1.0x0.42x16T
47 10 40 08	130x1.1x0.44x15T
47 10 40 09	130x1.2x0.46x14T
47 10 40 10	130x1.35x0.49x13T
47 10 40 11	130x1.5x0.5x12T
47 10 40 12	130x1.55x0.5x11T
47 10 40 13	130x1.7x0.52x10T

CARBIDE TIPS SAW BLADE

- ▶ Carbide tips coating
- ▶ With hard cutting

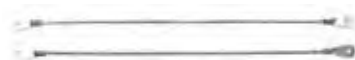

Item no.	Contents
47 10 00 31	12"

BAND SAW BLADE

- ▶ High carbon steel material
- ▶ With heat treatment
- ▶ Black finish



Item no.	Contents
47 10 20 13	thickness width tooth pitch 0.6x10/13/15x6mm
47 10 20 14	0.7x15/20/25/30x8mm
47 10 20 15	0.8x30/35x8mm
47 10 20 16	0.9x40x9mm
47 10 20 17	0.9x45x10mm
47 10 20 18	0.9x50x12mm

T118(BOSCH MODEL) JIG SAW BLADE

- ▶ HSS/Bi-metal
- ▶ Milled teeth
- ▶ 12T/21T/32T



Item no.	Contents
47 10 00 32	75mm, TEETH LENGTH:50mm

8PCS JIG SAW BLADE SET

- ▶ HCS material
- ▶ Different teeth for different purpose
- ▶ Milled teeth



Item no.	Contents
47 90 00 03	



CUT OFF WHEELS

- ▶ For metal
- ▶ Straight or curved type
- ▶ MPA-approval



Item no.	Contents
47 20 00 01	115x3x22.2mm
47 20 00 02	125x3x22.2mm
47 20 00 03	180x3x22.2mm
47 20 00 04	230x3x22.2mm

CUT OFF WHEELS

- ▶ For stone
- ▶ Straight or curved type
- ▶ MPA-approval



Item no.	Contents
47 20 00 05	115x3x22.2mm
47 20 00 06	125x3x22.2mm
47 20 00 07	180x3x22.2mm
47 20 00 08	230x3x22.2mm

GRINDING WHEELS

- ▶ For metal
- ▶ Curved type
- ▶ MPA-approval



Item no.	Contents
47 20 00 09	115x6x22.2mm
47 20 00 10	125x6x22.2mm
47 20 00 11	180x6x22.2mm
47 20 00 12	230x6x22.2mm

GRINDING WHEELS

- ▶ For stone
- ▶ Curved type
- ▶ MPA-approval



Item no.	Contents
47 20 00 13	115x6x22.2mm
47 20 00 14	125x6x22.2mm
47 20 00 15	180x6x22.2mm
47 20 00 16	230x6x22.2mm

CUT OFF WHEELS

- ▶ For stainless steel
- ▶ Straight or curved type
- ▶ MPA-approval



Item no.	Contents
47 20 00 17	115x1.0x22.2mm
47 20 00 18	125x1.6x22.2mm
47 20 00 19	180x2.5x22.2mm
47 20 00 20	230x3.0x22.2mm

GRINDING WHEELS

- ▶ For stainless steel
- ▶ Curved type
- ▶ MPA-approval



Item no.	Contents
47 20 00 21	115x6x22mm
47 20 00 22	125x6x22mm
47 20 00 23	180x6x22mm
47 20 00 24	230x6x22mm

T.C.T. CIRCULAR SAW BLADES

- ▶ Quality tungsten carbide tipped(T.C.T)blades
- ▶ Silver soldered to the body
- ▶ Ground to a keen micro sharp edge
- ▶ Heat-treated steel alloy body
- ▶ Surface ground for uniform thickness
- ▶ Hand tensioned



Item no.	Contents
47 20 20 01	110x1.9x1.2x30
47 20 20 02	160x2.3x1.5x40
47 20 20 03	190x2.3x1.5x40
47 20 20 04	210x2.6x1.8x60
47 20 20 05	250x2.8x2.0x60
47 20 20 06	300x3.2x2.2x60
47 20 20 07	350x3.5x2.5x80
47 20 20 08	250x2.7x2.0x80
47 20 20 09	300x3.0x2.2x100
47 20 20 10	350x3.2x2.5x120



CIRCULAR TIPPED SAW BLADES

- ▶ Tungsten carbide tipped
- ▶ Suitable for wood
- ▶ Particularly suitable for plastic-coated panels and plastics clean cut



Item no.	Contents
47 20 20 11	150mmx18T
47 20 20 12	180mmx24T
47 20 20 13	205mmx24T
47 20 20 14	230mmx40T

3PCS T.C.T. CIRCULAR SAW BLADE SET

- ▶ Tungsten carbide tipped
- ▶ Suitable for wood
- ▶ Particularly suitable for plastic-coated panels and plastics clean cut
- ▶ Aluminum box with transparent window



Item no.	Contents
47 90 00 04	

DIAMOND-CUTTING DISCS

- ▶ Continuous rim, sintered
- ▶ For tiles, Ceramics, Marble, thin granites
- ▶ MPA-approval



Item no.	Contents
47 20 40 01	110x5.0x22.23mm
47 20 40 02	115x5.0x22.23mm
47 20 40 03	125x5.0x22.23mm
47 20 40 04	180x5.0x22.23mm
47 20 40 05	230x5.0x22.23mm

DIAMOND-CUTTING DISCS

- ▶ Segmented rim, sintered
- ▶ For concrete, roofing tiles, bricks, common construction material etc
- ▶ MPA-approval.



Item no.	Contents
47 20 40 06	110x7.0x22.23mm
47 20 40 07	115x7.0x22.23mm
47 20 40 08	125x7.0x22.23mm
47 20 40 09	180x7.0x22.23mm
47 20 40 10	230x7.0x22.23mm

DIAMOND-CUTTING DISCS

- ▶ Turbo rim, sintered
- ▶ For granite, marble, concrete, asphalt etc
- ▶ MPA-approval.



Item no.	Contents
47 20 40 11	110x7.5x22.23mm
47 20 40 12	115x7.0x22.23mm
47 20 40 13	125x7.5x22.23mm
47 20 40 14	180x7.5x22.23mm
47 20 40 15	230x7.5x22.23mm

DIAMOND-CUTTING DISCS

- ▶ Turbo waved rim, sintered
- ▶ For granite, marble, concrete, asphalt etc
- ▶ MPA-approval.



Item no.	Contents
47 20 40 16	110x8.0x22.23mm
47 20 40 17	115x8.0x22.23mm
47 20 40 18	125x8.3x22.23mm
47 20 40 19	180x9.0x22.23mm
47 20 40 20	230x9.0x22.23mm

LASER WELDED SEGMENT RIM DIAMOND BLADES

- ▶ Suitable for Granite
- ▶ MPA-approval.



Item no.	Contents
47 20 40 21	110x22.2x7.0x2.2
47 20 40 22	125x22.2x7.0x2.2
47 20 40 23	180x25.4x7.0x2.5
47 20 40 24	250x25.4x7.0x2.7
47 20 40 25	300x32x8.0x3.2

DIAMOND GRINDING WHEEL



Item no.	Contents
47 20 40 26	100
47 20 40 27	125
47 20 40 28	150
47 20 40 29	200
47 20 40 30	250
47 20 40 31	300

DIAMOND GRINDING WHEEL



Item no.	Contents
47 20 40 32	100
47 20 40 33	125
47 20 40 34	150
47 20 40 35	200
47 20 40 36	250
47 20 40 37	300

DIAMOND CUT-OFF WHEEL WITH CHROME PLATED



Item no.	Contents
47 20 40 38	75
47 20 40 39	100
47 20 40 40	150
47 20 40 41	180
47 20 40 42	200
47 20 40 43	230

DIAMOND CUT-OFF AND GRINDING WHEEL WITH CHROME PLATED



Item no.	Contents
47 20 40 56	75
47 20 40 57	100
47 20 40 58	150
47 20 40 59	180
47 20 40 60	200
47 20 40 61	230

E-CUT SAW BLADE NARROW



Item no.	Contents
47 20 50 01	35mm

DIAMOND CUT-OFF WHEEL WITH CHROME PLATED



Item no.	Contents
47 20 40 44	75
47 20 40 45	100
47 20 40 46	150
47 20 40 47	180
47 20 40 48	200
47 20 40 49	230

4PCS DIAMOND-CUTTING DISCS SET

► Packed in blow mould case



Item no.	Contents
47 90 00 05	2pcs Segmented rim
	1pc Continuous rim
	1pc Turbo rim

E-CUT SAW BLADE NARROW



Item no.	Contents
47 20 50 02	20mm

DIAMOND CUT-OFF AND GRINDING WHEEL WITH CHROME PLATED



Item no.	Contents
47 20 40 50	75
47 20 40 51	100
47 20 40 52	150
47 20 40 53	180
47 20 40 54	200
47 20 40 55	230



E-CUT SAW BLADE NARROW



Item no.	Contents
47 20 50 03	10mm



SAW

E-CUT SAW BLADE NARROW

► Bi-metal



Item no.	Contents
47 20 50 04	20mm

SEGMENT SAW BLADE

► For metal



Item no.	Contents
47 20 50 07	

GRIT SAND PAPER



Item no.	Contents
47 20 50 10	

FIXED SCRAPER BLADE



Item no.	Contents
47 20 50 05	

CARBIDE SEGMENT SAW BLADE



Item no.	Contents
47 20 50 08	

HOOK AND LOOP SAND PAD



Item no.	Contents
47 20 50 11	

SEGMENT SAW BLADE



Item no.	Contents
47 20 50 06	

CARBIDE RASP



Item no.	Contents
47 20 50 09	



3PCS WOOD WORKING KIT



Item no.	Contents
47 20 50 12	

5PCS SAW BLADE FOR OSCILLATING TOOL



Item no.	Contents
47 20 50 15	

90° ANGLE CHUCK WITH KEY



Item no.	Contents
47 20 50 18	

4PCS SAW BLADE FOR OSCILLATING TOOL



Item no.	Contents
47 20 50 13	

5PCS SAW BLADE FOR OSCILLATING TOOL



Item no.	Contents
47 20 50 16	

KEYLESS 90° ANGLE CHUCK



Item no.	Contents
47 20 50 19	

4PCS SAW BLADE FOR OSCILLATING TOOL



Item no.	Contents
47 20 50 14	

3/8" ANGLE DRILL ATTACHMENT WITH KEYLESS CHUCK



Ball bearing shaft support

Item no.	Contents
47 20 50 17	

6PC. ANGLE BITS ATTACHMENT SET



Item no.	Contents
47 20 50 20	

1/4" ANGLE NUT RUNNER



Item no.	Contents
47 20 50 21	

4PC.COUNTERSINK BITS SET



Item no.	Contents
47 20 50 24	

10PC.1/4"ANGLE NUT RUNNER SET



Item no.	Contents
47 20 50 22	

5PC.HSS SCREW REMOVE SET



Item no.	Contents
47 20 50 25	

ANGLE ADAPTER FOR DRILL



Item no.	Contents
47 20 50 23	

23PC.MULTI-PURPOSE DRILL BITS SET



Item no.	Contents
47 20 50 26	

14 PCS SAW BLADES FOR OSCILLATING TOOL

▶ Aluminum case



Item no.	Contents
47 20 50 27	E-Cut saw blade narrow(35mm)×2
	E-Cut saw blade narrow(20mm)×1
	E-Cut saw blade narrow(10mm)×1
	Bi-Metal E-CUT saw blade narrow×2
	Segment saw blade-for metal×1
	Carbide segment saw blade×1
	Carbide rasp×1
	E-CUT scraper blade×1
	Fixed scraper blade×1
	Hook and Loop Sand Pad×1
	Grit Sand Paper(wood)×5
	Grit Sand Paper(metal)×5



12 PCS SAW BLADES FOR OSCILLATING TOOL

▶ Aluminum case



Item no.	Contents
47 20 50 28	E-Cut saw blade narrow(35mm)×1 E-Cut saw blade narrow(20mm)×1 E-Cut saw blade narrow(10mm)×1 Bi-Metal E-CUT saw blade narrow×1 Segment saw blade-for metal×1 Carbide segment saw blade×1 Carbide rasp×1 E-CUT scraper blade×1 Fixed scraper blade×1 Hook and Loop Sand Pad×1 Grit Sand Paper(wood)×5 Grit Sand Paper(metal)×5



9 PCS SAW BLADES FOR OSCILLATING TOOL

▶ Aluminum case



Item no.	Contents
47 20 50 29	E-Cut saw blade narrow(35mm)×1 E-Cut saw blade narrow(20mm)×1 E-Cut saw blade narrow(10mm)×1 Bi-Metal E-CUT saw blade narrow×1 Segment saw blade-for metal×1 Carbide segment saw blade×1 Carbide rasp×1 E-CUT scraper blade×1 Fixed scraper blade×1

HACKSAW FRAME

- ▶ Flat steel frame
- ▶ With lacquer painting
- ▶ Wood handle
- ▶ For 300mm blade



Item no.	Contents
47 30 00 01	300mm

HACKSAW FRAME

- ▶ Flat steel frame
- ▶ With black finish
- ▶ Wood handle
- ▶ For 300mm blade



Item no.	Contents
47 30 00 02	300mm

HACKSAW FRAME

- ▶ Flat steel frame
- ▶ Chrome plated
- ▶ Steel handle
- ▶ For 300mm blade



Item no.	Contents
47 30 00 03	300mm

HACKSAW FRAME

- ▶ Square lacquered steel tube bow frame
- ▶ With ABS handle



Item no.	Contents
47 30 00 04	300mm

HACKSAW FRAME

- ▶ Round lacquered steel tube bow frame
- ▶ With plastic & TPR handle
- ▶ With 2pcs steel blades + 1pc garden saw



Item no.	Contents
47 30 00 05	300mm

HACKSAW FRAME

- ▶ Square lacquered steel tube bow frame
- ▶ With aluminum handle



Item no.	Contents
47 30 00 06	300mm

HACKSAW FRAME

- ▶ Adjustable oval chrome plated steel tube bow frame
- ▶ With aluminum handle for 250mm or 300mm blade.



Item no.	Contents
47 30 00 07	250-300mm

HACKSAW FRAME

- ▶ Round lacquered steel tube bow frame
- ▶ With aluminum and TPR handle



Item no. 47 30 00 08 **Contents**

SQUARE TUBE HACKSAW

- ▶ Aluminum handle,
- ▶ Both head and handle with TPR coated grip
- ▶ Carbon steel blade



Item no. 47 30 10 03 **Contents** 300mm

STEEL PLATE HACKSAW FRAME

- ▶ Chrome coating frame
- ▶ Both head and handle with TPR coated grip
- ▶ Carbon steel blade



Item no. 47 30 10 08 **Contents** 300mm

HACKSAW FRAME

- ▶ Square lacquered steel tube bow frame
- ▶ With aluminum & TPR handle



Item no. 47 30 00 09 **Contents** 300mm

HACKSAW FRAME

- ▶ Tube bow frame
- ▶ Aluminium handle with TPR grip



Item no. 47 30 10 04 **Contents** 300mm

BOW HACKSAW FRAME

- ▶ Aluminum handle, handle with TPR coated grip
- ▶ Carbon steel blade



Item no. 47 30 10 09 **Contents** 300mm

HACKSAW FRAME

- ▶ Aluminum bow frame
- ▶ With aluminum & TPR handle



Item no. 47 30 00 10 **Contents** 300mm

PROFESSIONAL ALUMINIUM HACKSAW FRAME

- ▶ The blade is clamped by simply turning the button in the handle



Item no. 47 30 10 05 **Contents** 300mm

HACKSAW FRAME

- ▶ Tube bow frame
- ▶ Plastic handle with TPR grip
- ▶ Carbon steel blade



Item no. 47 30 10 10 **Contents** 300mm

HEAVY DUTY SQUARE TUBE HACKSAW

- ▶ Aluminum handle,
- ▶ Both head and handle with TPR coated grip
- ▶ Carbon steel blade



Item no. 47 30 10 01 **Contents** 300mm

ADJUSTABLE HACKSAW FRAME

- ▶ Steel plate frame
- ▶ With plastic handle
- ▶ Carbon steel blade



Item no. 47 30 10 06 **Contents** 300mm

HACKSAW FRAME

- ▶ Steel plate frame
- ▶ Casting aluminum handle
- ▶ Carbon steel blade



Item no. 47 30 10 11 **Contents** 300mm

HEAVY DUTY ALUMINIUM HACKSAW FRAME

- ▶ With TPR coated grip
- ▶ Carbon steel blade



Item no. 47 30 10 02 **Contents** 300mm

HEAVY DUTY PROFESSIONAL ALUMINIUM HACKSAW FRAMEHACKSAW FRAME

- ▶ Heavy duty construction
- ▶ Convenient blade releasing mechanism
- ▶ Both head and handle with TPR coated grip
- ▶ With bi-metal saw blade



Item no. 47 30 10 07 **Contents** 300mm

ADJUSTABLE HACKSAW FRAME

- ▶ Steel plate frame
- ▶ With TPR coated grip
- ▶ Carbon steel blade



Item no. 47 30 10 12 **Contents** 250-300mm

ADJUSTABLE HACKSAW FRAME

- ▶ Steel plate frame
- ▶ With TPR coated grip
- ▶ Carbon steel blade



Item no.	Contents
47 30 10 13	300mm

ADJUSTABLE HACKSAW FRAME

- ▶ Steel plate frame
- ▶ With plastic anti-slip handle
- ▶ Carbon steel blade



Item no.	Contents
47 30 10 14	300mm

MULTI-FUNCTION COMBINED

- ▶ ABS for both forearm and handle,
- ▶ TPR for outsourcing,
- ▶ Q195 oval tubular,



Item no.	Contents
47 30 10 15	6" + 12"

4PCS HACKSAW FRAME SET

- ▶ Square lacquered steel tube frame with aluminum handle
- ▶ TPR coating handle, for 300mm blade,
- ▶ Aluminum mini saw frame
- ▶ Aluminum body mini saw
- ▶ Miter box



Item no.	Contents
47 90 00 06	

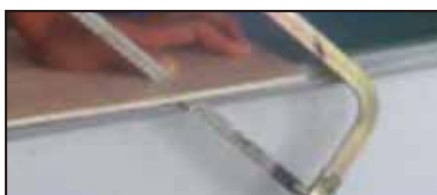

HAND PULLING SAW

- ▶ #65 Mn steel blade with heat treatment
- ▶ ABS handle



Item no.	Contents
47 99 00 01	660mm
47 99 00 02	730mm

BOW SAW

- ▶ Tube frame
- ▶ Material of saw blade:65Mn/50Mn
- ▶ Double-side grinding teeth hardened by high frequency current
- ▶ Chrome plated handle



Item no.	Contents
47 30 20 01	18"
47 30 20 02	21"
47 30 20 03	24"
47 30 20 04	30"
47 30 20 05	36"

BOW SAW

- ▶ Tube frame
- ▶ Material of saw blade:65Mn/50Mn
- ▶ Double-side grinding teeth hardened by high frequency current
- ▶ Chrome plated handle



Item no.	Contents
47 30 20 06	12"
47 30 20 07	18"
47 30 20 08	21"
47 30 20 09	24"
47 30 20 10	30"
47 30 20 11	36"

BOW SAW

- ▶ Tube frame
- ▶ Material of saw blade:50Mn
- ▶ Double-side grinding teeth hardened by high frequency current
- ▶ Galvanized handle



Item no.	Contents
47 30 20 12	12"
47 30 20 13	18"
47 30 20 14	21"
47 30 20 15	24"
47 30 20 16	30"
47 30 20 17	36"

TUBE FRAME SET

- ▶ Material of saw blade:65Mn/50 Mn/T10/SK5
- ▶ Double-side grinding teeth hardened by high frequency current
- ▶ PP/PTR plastic protective gloves
- ▶ Plastic-immersed Chrome plated handle



Item no.	Contents
47 90 00 07	12" + 30"

COMBINATION BPW SAW

- ▶ With comfortable plastic handle
- ▶ With 3 sawblades
- ▶ One is for wood/plastic
- ▶ Two for metal cutting



Item no.	Contents
47 30 00 11	300mm

MITRE SAW

- ▶ Comprising saw with aluminum handle
- ▶ 550mm cutting blades
- ▶ Solid one piece diecast aluminum saw table on wooden plate
- ▶ 4 chrome plated guide rods with adjustable length stop
- ▶ Material vice lamp cutting depth regulator and scale on the base.



Item no.	Contents
47 30 40 01	550x120mm

MITRE SAW

- ▶ Professional, Comprising saw with aluminum handle
- ▶ 600mm cutting blades
- ▶ Solid one piece diecast aluminum saw table on wooden plate
- ▶ 4 chrome plated guide rods, which can be setted mitre at 22.5, 30, 36, 45, 90 degree vertical condition with adjustable length stop.
- ▶ Material vice lamp cutting depth regulator and scale on the base



Item no.	Contents
47 30 40 02	600x160mm

MINI HACKSAW FRAME

- ▶ WOODEN HANDLE



Item no.	Contents
47 30 60 01	150mm

ALUMINIUM HACKSAW FRAME

- ▶ With TPR grip
- ▶ Carbon steel blade



Item no.	Contents
47 30 60 06	150mm

MINI HANDSAW

- ▶ Aluminum handle with quick release button
- ▶ With carbon steel saw blade



Item no.	Contents
47 30 60 11	150mm

COPING FRAME

- ▶ Flat chrome plated steel frame
- ▶ With 5 saw blades and wooden handle



Item no.	Contents
47 30 60 02	150mm

MINI HACKSAW FRAME

- ▶ High quality aluminum
- ▶ Plastic coated handle



Item no.	Contents
47 30 60 07	150mm

LABORSAVING SAW

- ▶ Plastic frame & handle
- ▶ With spring system for saving labor



Item no.	Contents
47 30 60 12	300mm

MINI HACKSAW FRAME

- ▶ A3 carbon steel Chrome plated frame
- ▶ #60 high carbon steel blade
- ▶ ABS+TPR handle



Item no.	Contents
47 30 60 03	150mm

MINI HACKSAW FRAME

- ▶ Square chrome plated steel frame
- ▶ Aluminium handle



Item no.	Contents
47 30 60 08	150mm

MULTI-PURPOSE HAND SAW

- ▶ Zinc alloy frame & handle
- ▶ With 2 pcs saw blades



Item no.	Contents
47 99 00 03	300mm

MINI HACKSAW FRAME

- ▶ Steel wire frame & handle
- ▶ With saw blade



Item no.	Contents
47 30 60 04	150mm

MINI HANDSAW

- ▶ Plastic handle with quick release button
- ▶ With carbon steel saw blade



Item no.	Contents
47 30 60 09	300mm

MINI HACKSAW FRAME

- ▶ Aluminium handle
- ▶ With bi-metal saw blade



Item no.	Contents
47 30 60 10	300mm

MINI HACKSAW FRAME

- ▶ Pressed steel Chrome plated frame
- ▶ With wood handle
- ▶ With saw blade



Item no.	Contents
47 30 60 05	

MINI HANDSAW

- ▶ Aluminum handle with quick release button
- ▶ With carbon steel saw blade



Item no.	Contents
47 30 60 10	300mm

HACKSAW

- ▶ Ergonomic rubber grip. Precision ground teeth
- ▶ Impulse hardened teeth. 65 Mn alloy steel blade
- ▶ Dynamic teeth set
- ▶ Available teeth type: aggressive cut/universal cut/cross cut
- ▶ Available teeth space: 6 TPI/8TPI/11TPI

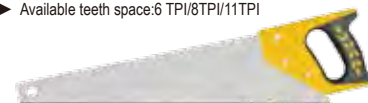

Item no.	Contents
47 40 00 01	400mm
47 40 00 02	450mm
47 40 00 03	500mm

HACKSAW

- ▶ Ergonomic rubber grip. Precision ground teeth
- ▶ Impulse hardened teeth. 65 Mn alloy steel blade
- ▶ Dynamic teeth set
- ▶ Available teeth type: aggressive cut/universal cut/cross cut
- ▶ Available teeth space:6 TPI/8TPI/11TPI



Item no.	Contents
47 40 00 04	400mm
47 40 00 05	450mm
47 40 00 06	500mm

HACKSAW

- ▶ Precision ground teeth; Impulse hardened teeth
- ▶ 65 Mn alloy steel blade
- ▶ Dynamic teeth set
- ▶ Strong hardwood grip
- ▶ Available teeth type: universal cut/cross cut
- ▶ Available teeth space: 6 TPI/8TPI/11TPI



Item no.	Contents
47 40 00 19	400mm
47 40 00 20	450mm
47 40 00 21	500mm

BACK SAW

- ▶ Adjustable cutting angles
- ▶ Ground cross cut teeth
- ▶ Ergonomic rubber grip. Impulse hardened teeth
- ▶ 65 Mn alloy steel blade
- ▶ Dynamic teeth set
- ▶ Available teeth space: 11 TPI/13TPI



Item no.	Contents
47 40 00 29	250mm
47 40 00 30	300mm

HACKSAW

- ▶ Ergonomic rubber grip. Precision ground teeth
- ▶ Impulse hardened teeth. 65 Mn alloy steel blade
- ▶ Dynamic teeth set
- ▶ Available teeth type: aggressive cut/universal cut/cross cut
- ▶ Available teeth space:6 TPI/8TPI/11TPI



Item no.	Contents
47 40 00 07	400mm
47 40 00 08	450mm
47 40 00 09	500mm

HACKSAW

- ▶ Precision ground teeth; Impulse hardened teeth
- ▶ 65 Mn alloy steel blade
- ▶ Dynamic teeth set
- ▶ Strong hardwood grip
- ▶ Available teeth type: universal cut/cross cut
- ▶ Available teeth space: 6 TPI/8TPI/11TPI



Item no.	Contents
47 40 00 22	400mm
47 40 00 23	450mm
47 40 00 24	500mm

BACK SAW

- ▶ Adjustable cutting angles
- ▶ Ground cross cut teeth
- ▶ Strong hardwood grip
- ▶ Impulse hardened teeth
- ▶ 65 Mn alloy steel blade
- ▶ Dynamic teeth set
- ▶ Available teeth space: 11 TPI/13TPI



Item no.	Contents
47 40 00 31	250mm
47 40 00 32	300mm

HACKSAW

- ▶ Ergonomic rubber grip. Precision ground teeth
- ▶ Impulse hardened teeth. 65 Mn alloy steel blade
- ▶ Dynamic teeth set
- ▶ Available teeth type: aggressive cut/universal cut/cross cut
- ▶ Available teeth space:6 TPI/8TPI/11TPI



Item no.	Contents
47 40 00 13	400mm
47 40 00 14	450mm
47 40 00 15	500mm

BACK SAW

- ▶ Adjustable cutting angles
- ▶ Ground cross cut teeth
- ▶ Ergonomic rubber grip. Impulse hardened teeth
- ▶ 65 Mn alloy steel blade
- ▶ Dynamic teeth set
- ▶ Available teeth space: 11 TPI/13TPI



Item no.	Contents
47 40 00 25	250mm
47 40 00 26	300mm

BACK SAW

- ▶ ABS plastic grip
- ▶ 65Mn alloy steel blade
- ▶ Punched cross cut teeth
- ▶ Dynamic teeth set
- ▶ Available teeth space:11points/13points



Item no.	Contents
47 40 00 33	250mm
47 40 00 34	300mm

HACKSAW

- ▶ Ergonomic rubber grip. Precision ground teeth
- ▶ Impulse hardened teeth. 65 Mn alloy steel blade
- ▶ Dynamic teeth set
- ▶ Available teeth type: aggressive cut/universal cut/cross cut
- ▶ Available teeth space:6 TPI/8TPI/11TPI



Item no.	Contents
47 40 00 16	400mm
47 40 00 17	450mm
47 40 00 18	500mm

VENEER SAW

- ▶ Curved cutting edge
- ▶ Ground cross cut teeth
- ▶ Ergonomic rubber grip
- ▶ Impulse hardened teeth
- ▶ 65 Mn alloy steel blade
- ▶ Dynamic teeth set
- ▶ Available teeth space: 11 TPI/13TPI

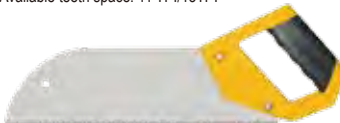

Item no.	Contents
47 40 00 27	250mm
47 40 00 28	300mm

MITREBOX WITH BACK SAW

- ▶ ABS plastic mitrebox
- ▶ 65Mn alloy steel blade
- ▶ Ground cross cut teeth
- ▶ Impulse hardened teeth
- ▶ Ergonomic rubber grip.teeth space:13TPI



Item no.	Contents
47 40 00 35	300mm

MITREBOX WITH BACK SAW

- ▶ Wooden mitrebox
- ▶ 65Mn alloy steel blade
- ▶ Ground cross cut teeth
- ▶ Impulse hardened teeth
- ▶ Ergonomic rubber grip,teeth space:13TPI



Item no.	Contents
47 40 00 36	300mm

HACKSAW

- ▶ Ergonomic rubber grip. Precision ground teeth
- ▶ Impulse hardened teeth. 65 Mn alloy steel blade
- ▶ Dynamic teeth set
- ▶ Available teeth type: aggressive cut/universal cut/cross cut
- ▶ Available teeth space:6 TPI/8TPI/11TPI



Item no.	Contents
47 40 10 07	400mm
47 40 10 08	450mm
47 40 10 09	500mm

HACKSAW

- ▶ Ergonomic rubber grip. Precision ground teeth
- ▶ Impulse hardened teeth. 65 Mn alloy steel blade
- ▶ Dynamic teeth set
- ▶ Available teeth type: aggressive cut/universal cut/cross cut
- ▶ Available teeth space:6 TPI/8TPI/11TPI



Item no.	Contents
47 40 00 19	400mm
47 40 10 20	450mm
47 40 10 21	500mm

MITREBOX WITH BACK SAW

- ▶ Plastic mitrebox
- ▶ 65Mn alloy steel blade
- ▶ Ground cross cut teeth
- ▶ Impulse hardened teeth
- ▶ Ergonomic rubber grip,teeth space:13TPI



Item no.	Contents
47 40 00 37	300mm

HACKSAW

- ▶ Ergonomic rubber grip. Precision ground teeth
- ▶ Impulse hardened teeth. 65 Mn alloy steel blade
- ▶ Dynamic teeth set
- ▶ Available teeth type: aggressive cut/universal cut/cross cut
- ▶ Available teeth space:6 TPI/8TPI/11TPI



Item no.	Contents
47 40 00 10	400mm
47 40 00 11	450mm
47 40 00 12	500mm

HACKSAW

- ▶ Ergonomic rubber grip. Precision ground teeth
- ▶ Impulse hardened teeth. 65 Mn alloy steel blade
- ▶ Dynamic teeth set
- ▶ Available teeth type: aggressive cut/universal cut/cross cut
- ▶ Available teeth space:6 TPI/8TPI/11TPI



Item no.	Contents
47 40 10 22	400mm
47 40 10 23	450mm
47 40 10 24	500mm

HACKSAW

- ▶ Ergonomic rubber grip. Precision ground teeth
- ▶ Impulse hardened teeth. 65 Mn alloy steel blade
- ▶ Dynamic teeth set
- ▶ Available teeth type: aggressive cut/universal cut/cross cut
- ▶ Available teeth space:6 TPI/8TPI/11TPI



Item no.	Contents
47 40 10 01	400mm
47 40 10 02	450mm
47 40 10 03	500mm

HACKSAW

- ▶ Ergonomic rubber grip. Precision ground teeth
- ▶ Impulse hardened teeth. 65 Mn alloy steel blade
- ▶ Dynamic teeth set
- ▶ Available teeth type: aggressive cut/universal cut/cross cut
- ▶ Available teeth space:6 TPI/8TPI/11TPI



Item no.	Contents
47 40 10 13	400mm
47 40 10 14	450mm
47 40 10 15	500mm

PREMIER HAND SAW

- ▶ Die cast aluminum+ABS covered handle construction,
- ▶ plus three screws fastening ensure durable working
- ▶ TPR grip for comfortable holding
- ▶ Available teeth space:6 TPI/8TPI/11TPI



Item no.	Contents
47 40 10 25	400mm
47 40 10 26	450mm
47 40 10 27	500mm

HACKSAW

- ▶ Ergonomic rubber grip. Precision ground teeth
- ▶ Impulse hardened teeth. 65 Mn alloy steel blade
- ▶ Dynamic teeth set
- ▶ Available teeth type: aggressive cut/universal cut/cross cut
- ▶ Available teeth space:6 TPI/8TPI/11TPI



Item no.	Contents
47 40 10 04	400mm
47 40 10 05	450mm
47 40 10 06	500mm

HACKSAW

- ▶ Ergonomic rubber grip. Precision ground teeth
- ▶ Impulse hardened teeth. 65 Mn alloy steel blade
- ▶ Dynamic teeth set
- ▶ Available teeth type: aggressive cut/universal cut/cross cut
- ▶ Available teeth space:6 TPI/8TPI/11TPI



Item no.	Contents
47 40 10 16	400mm
47 40 10 17	450mm
47 40 10 18	500mm

BACK SAW

- ▶ Adjustable cutting angles
- ▶ Ground cross cut teeth
- ▶ Ergonomic rubber grip. Impulse hardened teeth
- ▶ 65 Mn alloy steel blade
- ▶ Dynamic teeth set
- ▶ Available teeth space: 11 TPI/13TPI



Item no.	Contents
47 40 10 28	250mm
47 40 10 29	300mm

BACK SAW

- ▶ Adjustable cutting angles
- ▶ Ground cross cut teeth
- ▶ Ergonomic rubber grip. Impulse hardened teeth
- ▶ 65 Mn alloy steel blade
- ▶ Dynamic teeth set
- ▶ Available teeth space: 11 TPI/13TPI



Item no.	Contents
47 40 10 30	250mm
47 40 10 31	300mm

PRUNING SAW

- ▶ High quality hardwood grip
- ▶ Non-displace curved cutting edge
- ▶ Ground aggressive pull cut teeth
- ▶ 65 Mn alloy steel blade
- ▶ Dynamic teeth set.



Item no.	Contents
47 40 20 04	330mm

UNIVERSAL GROUND SAW

- ▶ Ultra thick 65Mn alloy steel blade
- ▶ Precision ground teeth
- ▶ Impulse hardened teeth
- ▶ Non-slip notch grip
- ▶ Aggressive cut/universal cut
- ▶ Teeth space:8points
- ▶ Blade size:150mm



Item no.	Contents
47 40 00 39	150mm

BOARD SAW SET

- ▶ PP/TPR handle
- ▶ COLOR SLEEVE PACKING



Item no.	Contents
47 40 00 01	450mm, 300mm, 150mm

PRUNING SAW

- ▶ High quality hardwood grip
- ▶ Non-displace curved cutting edge
- ▶ Ground aggressive pull cut teeth
- ▶ 65 Mn alloy steel blade
- ▶ Dynamic teeth set.



Item no.	Contents
47 40 20 05	330mm

UNIVERSAL GROUND SAW

- ▶ Ultra thick 65Mn alloy steel blade
- ▶ Precision ground teeth
- ▶ Impulse hardened teeth
- ▶ Non-slip notch grip
- ▶ Available teeth type:
- ▶ Aggressive cut/universal cut
- ▶ Teeth space:8points
- ▶ Blade size:150mm



Item no.	Contents
47 40 00 60	150mm

PRUNING SAW

- ▶ High quality hardwood grip
- ▶ Non-displace curved cutting edge
- ▶ Ground aggressive pull cut teeth
- ▶ 65 Mn alloy steel blade
- ▶ Dynamic teeth set.



Item no.	Contents
47 40 20 01	330mm

PRUNING SAW

- ▶ 2 colors Plastic grip
- ▶ Non-displace curved cutting edge
- ▶ Ground aggressive pull cut teeth
- ▶ 65 Mn alloy steel blade
- ▶ Dynamic teeth set.



Item no.	Contents
47 40 20 06	330mm

UNIVERSAL GROUND SAW

- ▶ Ultra thick 65Mn alloy steel blade
- ▶ Precision ground teeth
- ▶ Impulse hardened teeth
- ▶ Non-slip notch grip
- ▶ Aggressive cut/universal cut
- ▶ Teeth space:8points
- ▶ Blade size:150mm



Item no.	Contents
47 40 00 61	150mm

PRUNING SAW

- ▶ High quality hardwood grip
- ▶ Non-displace curved cutting edge
- ▶ Ground aggressive pull cut teeth
- ▶ 65 Mn alloy steel blade
- ▶ Dynamic teeth set.



Item no.	Contents
47 40 20 02	280mm
47 40 20 03	330mm

UNIVERSAL GROUND SAW

- ▶ Ground universal pull cut
- ▶ 65Mn alloy steel blade
- ▶ Teeth space:13points
- ▶ Blade size:120mm



Item no.	Contents
47 40 00 38	120mm



UNIVERSAL GROUND SAW

- ▶ Ultra thick 65Mn alloy steel blade
- ▶ Precision ground teeth
- ▶ Impulse hardened teeth
- ▶ Non-slip notch grip
- ▶ Aggressive cut/universal cut
- ▶ Teeth space: 8points
- ▶ Blade size: 150mm



Item no.	Contents
47 40 00 62	150mm

UNIVERSAL GROUND SAW

- ▶ Ultra thick 65Mn alloy steel blade
- ▶ Precision ground teeth
- ▶ Impulse hardened teeth
- ▶ Non-slip notch grip
- ▶ Aggressive cut/universal cut
- ▶ Teeth space: 8points
- ▶ Blade size: 150mm



Item no.	Contents
47 40 00 63	150mm

PRUNING SAW

- ▶ Precision ground aggressive pull cut
- ▶ 65 Mn alloy steel blade
- ▶ Impulse hardened teeth
- ▶ ABS plastic blade grip and sheath
- ▶ Teeth space: 7 TPI.



Item no.	Contents
47 40 20 07	240mm
47 40 20 08	270mm
47 40 20 09	300mm
47 40 20 10	350mm

PRUNING SAW

- ▶ Precision ground aggressive pull cut
- ▶ Non-slip ergonomic rubber grip
- ▶ 65Mn alloy steel blade
- ▶ Impulse hardened teeth
- ▶ ABS plastic blade sheath
- ▶ Teeth space: 7 TPI.



Item no.	Contents
47 40 20 11	210mm
47 40 20 12	240mm
47 40 20 13	270mm
47 40 20 14	300mm

PRUNING SAW

- ▶ Pistol shaped ergonomic grip
- ▶ Non-displace curved cutting edge
- ▶ Ground aggressive pull cut teeth
- ▶ 65Mn alloy steel blade
- ▶ Dynamic teeth set



Item no.	Contents
47 40 20 15	330mm

PRUNING SAW

- ▶ Strong steel framework grip
- ▶ Precision ground aggressive pull cut
- ▶ 65 Mn ally steel blade. Impulse hardened teeth
- ▶ Safe blade lock button
- ▶ Teeth space: 8 TPI



Item no.	Contents
47 50 00 01	180mm

FOLDABLE SAW

- ▶ Medium size ergonomic rubber grip
- ▶ Precision ground aggressive pull cut
- ▶ 65 Mn alloy steel blade
- ▶ Ergonomic rubber grip
- ▶ Impulse hardened teeth
- ▶ Easy-press blade lock button
- ▶ Teeth space: 8 TPI



Item no.	Contents
47 50 00 02	180mm

FOLDABLE SAW

- ▶ Medium size ergonomic rubber grip
- ▶ Precision ground aggressive pull cut
- ▶ 65 Mn alloy steel blade
- ▶ Ergonomic rubber grip
- ▶ Impulse hardened teeth
- ▶ Easy-press blade lock button
- ▶ Teeth space: 8 TPI



Item no.	Contents
47 50 00 03	150mm

FOLDABLE SAW

- ▶ Medium size ergonomic rubber grip
- ▶ Precision ground aggressive pull cut
- ▶ 65 Mn alloy steel blade
- ▶ Ergonomic rubber grip
- ▶ Impulse hardened teeth
- ▶ Easy-press blade lock button
- ▶ Teeth space: 8 TPI



Item no.	Contents
47 50 00 04	180mm

FOLDABLE SAW

- ▶ Medium size ergonomic rubber grip
- ▶ Precision ground aggressive pull cut
- ▶ 65 Mn alloy steel blade
- ▶ Ergonomic rubber grip
- ▶ Impulse hardened teeth
- ▶ Easy-press blade lock button
- ▶ Teeth space: 8 TPI



Item no.	Contents
47 50 00 05	180mm

FOLDABLE SAW

- ▶ Medium size ergonomic rubber grip
- ▶ Precision ground aggressive pull cut
- ▶ 65 Mn alloy steel blade
- ▶ Ergonomic rubber grip
- ▶ Impulse hardened teeth
- ▶ Easy-press blade lock button
- ▶ Teeth space: 8 TPI



Item no.	Contents
47 50 00 06	180mm

FOLDABLE SAW

- ▶ Medium size ergonomic rubber grip
- ▶ Precision ground aggressive pull cut
- ▶ 65 Mn alloy steel blade
- ▶ Ergonomic rubber grip
- ▶ Impulse hardened teeth
- ▶ Easy-press blade lock button
- ▶ Teeth space: 8 TPI



Item no.	Contents
47 50 00 21	300mm

GARDEN SAW SET



Item no.	Contents
47 90 00 09	1pc garden saw 1pc pruning shear 1 pruning saw

FOLDABLE SAW

- ▶ Medium size ergonomic rubber grip
- ▶ Precision ground aggressive pull cut
- ▶ 65 Mn alloy steel blade
- ▶ Ergonomic rubber grip
- ▶ Impulse hardened teeth
- ▶ Easy-press blade lock button
- ▶ Teeth space: 8 TPI



Item no.	Contents
47 50 00 07	180mm

5 IN 1 HAND SAW SET

- ▶ ABS handle



Item no.	Contents
47 40 00 40	350mm hand saw, 0.7mm thickness, 7 teeth pressed teech #65Mn steel 250mm back saw, 0.5mm thickness, 12 teeth pressed teech #65Mn steel 300mm garden saw, 0.6mm thickness, 5 teeth pressed teech, #65Mn steel 295mm double sides metal saw, 0.6mm thickness, 24 teeth, 60# carbon steel miled teeth, HRC55-60 250mm pruning saw, 0.7mm thickness, 7 teeth pressed teech, #65Mn steel

FOLDABLE SAW

- ▶ Medium size ergonomic rubber grip
- ▶ Precision ground aggressive pull cut
- ▶ 65 Mn alloy steel blade
- ▶ Ergonomic rubber grip
- ▶ Impulse hardened teeth
- ▶ Easy-press blade lock button
- ▶ Teeth space: 8 TPI



Item no.	Contents
47 50 00 08	180mm



LEAF RAKE

- ▶ Carbon steel
- ▶ Powder coating
- ▶ Telescopic handle
- ▶ With soft plastic grip



Item no.	Contents
50 20 00 01	79x10.4cm Max length:118cm

LEAF RAKE



Item no.	Contents
50 20 00 02	79x14cm Max length:107cm

TWO-WAY HOE



Item no.	Contents
50 20 00 03	62.8x18.5cm Max length:95.5cm

TWO-WAY HOE



Item no.	Contents
50 20 00 04	63x18cm Max length:95cm

SMALL RAKE



Item no.	Contents
50 20 00 05	63.2x 8.6cm Max length:95cm

HAND CULTIVATOR



Item no.	Contents
50 20 00 06	71x8.2cm Max length:103cm

HAND TROWEL



Item no.	Contents
50 20 00 09	69x9.4cm Max length:100cm

HAND TROWEL

- ▶ Aluminum
- ▶ Mirror polished
- ▶ With double components soft TPR handle



Item no.	Contents
50 20 00 10	31x7.5cm

TRANSPLANTING TROWEL



Item no.	Contents
50 20 00 11	30.8x5.5cm

WEEDING FORK



Item no.	Contents
50 20 00 12	30x7.8cm

3 PRONG HAND FORK



Item no.	Contents
50 20 00 13	30x7.8cm

HAND WEEDER



Item no.	Contents
50 20 00 14	30x8.4cm

3 PRONG HAND FORK

- ▶ Aluminum
- ▶ mirror polished
- ▶ with plastic handle



Item no.	Contents
50 20 00 15	22.6x7.2cm

TRANSPLANTING TROWEL



Item no.	Contents
50 20 00 16	27.8x6cm

WEEDING FORK



Item no.	Contents
50 20 00 17	27.5x7.9cm

HAND WEEDER

- ▶ Stainless steel
- ▶ Mirror polished
- ▶ With double components TPR handle



Item no.	Contents
50 20 00 23	34.8x5.1cm

HAND WEEDER

- ▶ Stainless steel
- ▶ Mirror polished with polished steel ferrule
- ▶ Fine wood handle



Item no.	Contents
50 20 00 28	29.5x8.8cm

HAND TROWEL

- ▶ Carbon steel
- ▶ powder coating
- ▶ With polished steel ferrule
- ▶ Fine wood handle



Item no.	Contents
50 20 00 32	29.2x8.8cm

HAND CULTIVATOR



Item no.	Contents
50 20 00 24	29.2x9.5cm

TRANSPLANTING TROWEL



Item no.	Contents
50 20 00 29	29.5x8.8cm

TRANSPLANTING TROWEL



Item no.	Contents
50 20 00 33	29.2x8.8cm

WEEDING FORK



Item no.	Contents
50 20 00 25	33.5x7.2cm

TWO-WAY HOE



Item no.	Contents
50 20 00 30	26.8x15cm

WEEDING FORK



Item no.	Contents
50 20 00 34	28x18cm

TRANSPLANTING TROWEL



Item no.	Contents
50 20 00 26	33.5x6.5cm

DANDELION WEEDER



Item no.	Contents
50 20 00 31	32.5cm

HAND CULTIVATOR



Item no.	Contents
50 20 00 35	27.8x9cm

HAND TROWEL



Item no.	Contents
50 20 00 27	38x8.1cm

HAND WEEDER



Item no. Contents

50 20 00 36 28.2x2.5cm

HAND TROWEL

- ▶ Nylon blade and handle
- ▶ with hang hole in handle



Item no. Contents

50 20 00 38 28.2x8.2cm

TRANSPLANTING TROWEL



Item no. Contents

50 20 00 39

WEEDING FORK



Item no. Contents

50 20 00 40 26.6x7.8cm

HAND CULTIVATOR



Item no. Contents

50 20 00 41 28x8cm

LEAF RAKE

- ▶ Carbon steel
- ▶ Powder coating
- ▶ With double components soft TPR handle.



Item no. Contents

50 20 00 42 29.2x8.8cm

TWO-WAY HOE



Item no. Contents

50 20 00 43 29.2x5.8cm

DANDELION WEEDER



Item no. Contents

50 20 00 44 28x18cm

HAND TROWEL



Item no. Contents

50 20 00 45 27.8x9cm

TRANSPLANTING TROWEL



Item no. Contents

50 20 00 46 28.2x2.5cm

MINI HAND TROWEL



Item no. Contents

50 20 00 47 26x8.2cm

HAND CULTIVATOR



Item no. Contents

50 20 00 48

HAND TROWEL

- ▶ Carbon steel
- ▶ Powder coating
- ▶ Fine wood handle with soft grip



Item no. Contents

50 20 00 49 54.2x8cm

TRANSPLANTING TROWEL



Item no. Contents

50 20 00 50 54.5x6.6cm

WEEDING FORK



Item no. Contents

50 20 00 51 51.6x8cm

HAND CULTIVATOR



Item no.	Contents
50 20 00 52	46.8x9cm

SMALL RAKE



Item no.	Contents
50 20 00 53	44x11.5cm

HAND DRAW HOE



Item no.	Contents
50 20 00 54	45x10cm

BULB PLANTER

- ▶ Designed for planting bulbs or plants in turf or heavy soil
- ▶ Turf core or soil discharged when spring-loaded handles released
- ▶ Depths of 50mm and 100mm clearly marked on side of planter
- ▶ Manufactured from chrome plated steel with plastic handle. Display packed



Item no.	Contents
50 30 00 01	60mm

DIBBER

- ▶ Die cast with pointed end with "L" shaped handle
- ▶ Designed to give maximum torque and operator comfort
- ▶ Planting depth 210mm. display packed



Item no.	Contents
50 30 00 02	60mm

DIBBER

- ▶ Gun metal grey hammer finished with "T" wooden handle



Item no.	Contents
50 30 00 03	

FRUIT PICKER

- ▶ Made from carbon steel, fine chrome plated



Item no.	Contents
50 20 40 01	

5 PCS GARDEN TOOLS SET

- ▶ Transplanting trowel, hand cultivator were manufactured from carbon steel, fine chrome plated, with soft plastic handles. Pruning shear manufactured from carbon steel, black finished, with plastic handle



Item no.	Contents
50 90 00 01	



11 PCS GARDEN TOOLS SET

- ▶ Carbon steel, powder coating two-way hoe, leaf rake, dibber
- ▶ Polished transplanting trowel, hand trowel with hard wood handle
- ▶ Shears were made from carbon steel, black finished, with plastic handle
- ▶ With strong and flexible garden twist tile, garden glove and plastic sprayer



Item no.	Contents
50 90 00 02	

12 PCS GARDEN TOOLS SET

- ▶ Aluminum blades, mirror polished, with soft plastic grips
- ▶ Pruning shears and grass shear manufactured from high carbon steel, with double components soft TPR handle



Item no.	Contents
50 90 00 03	

8 PCS GARDEN TOOLS SET

- ▶ Transplanting trowel, hand trowel, hand cultivator, dandelion weeder manufactured from carbon steel, powder coating, with plastic handle
- ▶ Grass shear was made from high carbon steel, export hardened, black finished, with plastic handle
- ▶ Garden shear was made from professional steel, fine polished and hardened, with double color plastic handle
- ▶ With 300m strong and flexible garden twist tile
- ▶ One piece folding seat, 40*29*33cm, chrome plated steel tube



Item no.	Contents
50 90 00 04	



3 PCS GARDEN TOOLS SET

- ▶ Nylon transplanting trowel, hard trowel
- ▶ Bulb planter was made of carbon steel, chrome plated, PP handle



Item no.	Contents
50 90 00 05	

3 PCS GARDEN TOOLS SET

- ▶ Grape shear high carbon steel drop forged, with double color dipped handle.
- ▶ Transplanting trowel, hand trowel manufactured from aluminum, mirror polished, double components; TPR handle.



Item no.	Contents
50 90 00 06	

3 PCS GARDEN TOOLS SET

- ▶ Stainless steel, mirror polished, with two components soft plastic handle



Item no.	Contents
50 90 00 07	

3 PCS GARDEN TOOLS SET

- ▶ Carbon steel, powder coating, with hardwood handle, TPR grip



Item no.	Contents
50 90 00 08	

7 PCS GARDEN TOOLS SET

- ▶ Stainless steel transplanting trowel, hand trowel, hand cultivator, mirror polished, with fine wood handle.
- ▶ Garden shear made of high carbon steel, plastic dipped handle, 8".
- ▶ With one pair garden glove and one piece apron.



Item no.	Contents
50 90 00 09	

7 PCS GARDEN TOOLS SET

- ▶ Transplanting trowel, hand trowel, hand cultivator manufactured from carbon steel, fine chrome plated, with hardwood handle.
- ▶ Pruning shear manufactured from high carbon steel, black finished, plastic handle.
- ▶ With 30m strong and flexible garden twist tie.
- ▶ With one piece sprayer and handbag.



Item no.	Contents
50 90 00 10	

5 PCS GARDEN TOOLS SET

- ▶ Aluminum 3 prong hand fork, transplanting trowel, hand trowel, mirror polished, with plastic dipped handle.
- ▶ With one pair glove and one piece handbag.



Item no.	Contents
50 90 00 11	

HOSE CONNECTOR

- ▶ Material: Plastic



Item no.	Contents
50 10 20 01	1/2"
50 10 20 02	3/4"

HOSE CONNECTOR WITH STOP

- ▶ Material: Plastic



Item no.	Contents
50 10 20 03	1/2"
50 10 20 04	3/4"

TAP ADAPTOR

- ▶ Material: Plastic



Item no.	Contents
50 10 20 05	1/2" & 3/4"
50 10 20 06	3/4" & 1"

FEMALE ADAPTOR

- ▶ Material: Plastic



Item no.	Contents
50 10 20 07	3/4"
50 10 20 08	1"

HOSE MENDER

► Material: plastic



Item no.	Contents
50 10 20 09	1/2"
50 10 20 10	3/4"

THREE-WAY HOSE CONNECTOR

► Material: plastic



Item no.	Contents
50 10 20 14	

HOSE MENDER

► Material: plastic
Bi-color
Packed in blister card



Item no.	Contents
50 10 30 04	1/2", 3/4"

TWO-WAY HOSE CONNECTOR

► Material: plastic



Item no.	Contents
50 10 20 11	

Y-SWITCH HOSE CONNECTOR WITH VALVE

► Material: plastic



Item no.	Contents
50 10 20 15	

HOSE MENDER

► Material: plastic
Bi-color
Packed in blister card



Item no.	Contents
50 10 30 05	1/2" to 3/4"

MALE ADAPTOR

► Material: plastic



Item no.	Contents
50 10 20 12	1/2" NPT

TAP ADAPTOR

► Material: plastic
Bi-color



Item no.	Contents
50 10 30 01	3/8"

TAP ADAPTOR

► Material: plastic
Soft coated



Item no.	Contents
50 10 30 06	1/2" to 3/4"

THREE-SECTION ADAPTOR

► Material: plastic



Item no.	Contents
50 10 20 13	3/4"

HOSE CONNECTOR

► Material: plastic
Packed in blister card
Bi-color



Item no.	Contents
50 10 30 02	A: 1/2", 3/4"
50 10 30 03	B: 1/2", 3/4" With water stop

HOSE CONNECTOR

► Material: plastic
Soft coated
Packed in blister card



Item no.	Contents
50 10 30 07	1/2", 3/4"



HOSE CONNECTOR

► Material is plastic, soft coated
Packed in blister card
With water stop



Item no.	Contents
50 10 30 08	1/2", 3/4"

HOSE CONNECTOR

► Material is plastic, soft coated
Packed in blister card



Item no.	Contents
50 10 30 09	1/2" to 3/4"

HOSE CONNECTOR

► Material is plastic, soft coated
Packed in blister card



Item no.	Contents
50 10 30 10	1/2", 3/4"

FEMALE ADAPTOR

► Material: brass



Item no.	Contents
50 10 20 16	1/2"
50 10 20 17	3/4"
50 10 20 18	1"

MALE ADAPTOR

► Material: brass



Item no.	Contents
50 10 20 19	1/2"
50 10 20 20	3/4" (BSP) Brass

TAP ADAPTOR

► Material: brass



Item no.	Contents
50 10 20 21	3/4" & 1"
50 10 20 22	1/2" & 3/4"

QUICK HOSE CONNECTOR

► Material: brass



Item no.	Contents
50 10 20 23	1/2"
50 10 20 24	3/4"

QUICK HOSE CONNECTOR WITH WATERSTOP

► Material: brass



Item no.	Contents
50 10 20 25	1/2"
50 10 20 26	3/4"

DOUBLE HOSE MENDER

► Material: brass



Item no.	Contents
50 10 20 27	1/2"
50 10 20 28	3/4"

TWO-WAY HOSE CONNECTOR

► Material: brass



Item no.	Contents
50 10 20 29	

THREE-WAY HOSE CONNECTOR

► Material: brass



Item no.	Contents
50 10 20 30	

COUPLING WITH VALVE

► Material: brass



Item no.	Contents
50 10 20 31	3/4"

TWO-WAY HOSE CONNECTOR WITH VALVE

► Material: brass



Item no.	Contents
50 10 20 32	

THREE-WAY HOSE CONNECTOR WITH VALVE

► Material: brass



Item no.	Contents
50 10 20 33	

FOUR-WAY HOSE CONNECTOR WITH VALVE

► Material: brass



Item no.	Contents
50 10 20 34	

ADJUSTABLE NOZZLE

► Material: brass



Item no.	Contents
50 10 40 01	4"

ADJUSTABLE NOZZLE

► Material: brass



Item no.	Contents
50 10 40 02	4"

4 PCS BASIC FITTING SET



Item no.	Contents
50 90 00 12	1/2" Quick Hose Connector
13 40 00 01	1/2" Quick Hose Connector with water stop
13 40 00 01	4" Adjustable Nozzle
13 40 00 01	3/4"&1" Tap Adaptor

4 PCS BASIC FITTING SET



Item no.	Contents
50 90 00 13	3/4" Female Adaptor
	1/2" Quick Hose Connector
	4" Adjustable nozzle
	1/2" Quick Hose Connector with water stop

4PCS BASIC FITTING SET



Item no.	Contents
50 90 00 14	3/4" Quick Hose Connector
13 40 00 01	3/4" Quick Hose Connector with water stop
13 40 00 01	4" Adjustable Nozzle
13 40 00 01	3/4"&1" Tap Adaptor

4PCS BASIC FITTING SET



Item no.	Contents
50 90 00 15	1/2" Quick Hose Connector
13 40 00 01	1/2" Quick Hose Connector with water stop
13 40 00 01	4" Adjustable Nozzle; 540037, 1/2" & 3/4" Tap Adaptor

2 PCS BASIC FITTING SET



Item no.	Contents
50 90 00 16	4" Adjustable Nozzle
13 40 00 01	1/2" Quick Hose Connector





4 PCS BASIC FITTING SET WITH RUBBER



Item no.	Contents
50 90 00 17	1/2" Quick Hose Connector
	1/2" Quick Hose Connector with water stop
	4" Adjustable Nozzle
	1/2"&3/4" Tap Adaptor

ADJUSTABLE HOSE NOZZLE

- ▶ Material: plastic



Item no.	Contents
50 10 40 03	

9 PATTERN PLASTIC TORCH NOZZLE

- ▶ 9-pattern include: center, mist, shower, angle, full, soaker, jet, circle, flat



Item no.	Contents
50 10 40 04	

PISTOL NOZZLE

- ▶ Adjustable spray from off, fine mist to powerful jet stream; Material: plastic



Item no.	Contents
50 10 40 05	

8-PATTERN SPRAY NOZZLE

- ▶ Adjustable spray from off,
- ▶ Fine mist to powerful jet stream 8 spray patterns: center, cone, stream, mist, vertical, flat, full, shower



Item no.	Contents
50 10 40 06	

8-PATTERN SPRAY NOZZLE

- ▶ Adjustable spray from off,
- ▶ Fine mist to powerful jet stream 8 spray patterns: center, cone, stream, mist, vertical, flat, full, shower;
- ▶ Material: plastic



Item no.	Contents
50 10 40 07	

7-PATTERN SPRAY NOZZLE

- ▶ Adjustable spray from off,
- ▶ Fine mist to powerful jet stream 7 spray patterns: center, cone, mist, jet, full, shower, soaker



Item no.	Contents
50 10 40 08	

PISTOL NOZZLE

- ▶ Zinc alloy body
- ▶ Adjustable spray from off, fine mist to powerful jet stream
- ▶ Impulse sprinkler



Item no.	Contents
50 10 40 09	

ZINC ALLOY 8-PATTERN SPRAY GUN

- ▶ 8 SPAY PATTERNS:JET-FLAT-SHOWER-MIST-CONE-SOAKER-FAN-QUAD



Item no.	Contents
50 10 40 10	

ZINC ALLOY 8-PATTERN SPRAY GUN

- ▶ 8 SPAY PATTERNS:JET-FLAT-SHOWER-MIST-CONE-SOAKER-FAN-QUAD



Item no.	Contents
50 10 40 11	

ZINC ALLOY SPRAY GUN

- ▶ WITH ADJUSTABLE BRASS TIP



Item no.	Contents
50 10 40 12	

8 SPRAY WATERING WAND

- ▶ 8 Spray Patterns:Angle, cone,soaker, mist, vertical, flat, full, shower
- ▶ 8_pattern Watering Wand



Item no.	Contents
50 10 40 13	70mm

8 SPRAY WATERING WAND

- ▶ 8 Spray Patterns: Angle, cone, soaker, mist, vertical, flat, full, shower
- ▶ 8_pattern Watering Wand



Item no.	Contents
50 10 40 14	38mm

SOFT COATED ADJUSTABLE SPRAY GUN

- ▶ Adjustable spray from off, fine mist to powerful jet system
- Material: Zinc alloy with ABS handle



Item no.	Contents
50 10 50 04	

ADJUSTABLE HOSE NOZZLE

- ▶ adjustable spray from off, fine mist to powerful jet stream.
- Material: PP, ABS



Item no.	Contents
50 10 50 08	

7-PATTERN SOFT COATED SPRAY GUN

- ▶ Include: center, mist, cone, full, angle, shower, flat
- Adjustable handle, with double color
- Material: Zinc alloy with ABS handle



Item no.	Contents
50 10 50 01	

7-PATTERN SOFT COATED SPRAY GUN

- ▶ Include: center, mist, cone, full, angle, shower, flat
- Material: Zinc alloy with ABS handle
- Double color handle



Item no.	Contents
50 10 50 05	

TWO WAY VALVE

- ▶ Material: PP
- Packed in Blister card



Item no.	Contents
50 10 50 09	

7-PATTERN SOFT COATED SPRAY GUN

- ▶ Include: center, mist, cone, full, angle, shower, flat
- Adjustable handle, with double color
- Material: Zinc alloy with ABS handle



Item no.	Contents
50 10 50 02	

SOFT COATED ADJUSTABLE SPRAY GUN

- ▶ Double color handle
- Zinc adjustable luxury nozzle
- Fine mist to powerful jet system



Item no.	Contents
50 10 50 06	

9-PATTERN PLASTIC WATERING WAND

- ▶ Double color handle
- Include: center, mist, shower, angle, full, soaker, jet, circle, flat



Item no.	Contents
50 10 50 10	

7-PATTERN SOFT COATED SPRAY GUN

- ▶ Include: center, mist, cone, full, angle, shower, flat
- Adjustable handle, with double color
- Material: Zinc alloy with ABS handle



Item no.	Contents
50 10 50 03	

ADJUSTABLE HOSE NOZZLE

- ▶ Adjustable spray from off, fine mist to powerful jet stream.
- Double color
- Material: pp, abs



Item no.	Contents
50 10 50 07	

4PCS BASIC HOSE SET



Item no.	Contents
50 90 00 18	adjustable hose nozzle
	1/2" hose connector
	1/2" hose connector with stop
	3/4" female adaptor



4PCS BASIC HOSE SET



Item no.	Contents
50 90 00 19	3/4"&1" tap adaptor 1/2" hose connector 1/2" hose connector with stop 7-pattern spray nozzle

4PCS BASIC HOSE SET



Item no.	Contents
50 90 00 20	1/2"&3/4" tap adaptor 1/2" hose connector 1/2" hose connector with stop 8-pattern spray nozzle

4PCS BASIC HOSE SET



Item no.	Contents
50 90 00 21	1/2"&3/4" tap adaptor 1/2" hose connector 1/2" hose connector with stop 8-pattern spray nozzle

IMPULSE SPRINKLER

- ▶ Material: Zinc alloy
- ▶ The pray coverage is up to 24 meters diameter with brass plated



Item no.	Contents
50 10 40 15	1/2"

IMPULSE SPRINKLER

- ▶ Material: Plastic
- ▶ The pray coverage is up to 24 meters diameter



Item no.	Contents
50 10 40 16	1/2"

IMPULSE SPRINKLER

- ▶ Material: Zinc alloy
- ▶ The pray coverage is up to 24 meters diameter with zinc plated spike



Item no.	Contents
50 10 40 17	1/2"

IMPULSE SPRINKLER

- ▶ Material: Plastic
- ▶ The pray coverage is up to 24 meters diameter with plastic spike



Item no.	Contents
50 10 40 18	

SPRINKLER STAND

- ▶ Full steel and reinforced nylon structure
- ▶ Chrome plated
- ▶ Intermediate rod is adjustable up to 33cm



Item no.	Contents
50 10 40 19	

PLASTIC IMPULSE SPRINKLER WITH PLASTIC SPIKE

- ▶ Circle or part circle operation
- The spray coverage is up to 24 meter diameter



Item no.	Contents
50 10 50 11	

PLASTIC IMPULSE SPRINKLER WITH ZINC SPIKE

- ▶ Circle or part circle operation
- The spray coverage is up to 24 meter diameter



Item no.	Contents
50 10 50 12	

3-ARM SPRINKLER WITH METAL SPIKE

- ▶ Circle or part circle operation
- The spray coverage is up to 24 meter diameter



Item no.	Contents
50 10 50 13	

DANCING FLOWER

► Material: plastic



Item no.	Contents
50 99 00 01	

SPRINKLER

► BUTTERFLY BASE SPRINKLER WITH THREE ARM



Item no.	Contents
50 10 40 22	

17-HOLE OSCILLATING SPRINKLER

- Gear drive motor operation for even, gentle lawn watering
- Maintenance-free, non-corroding gear motor-mechanism
- Wide adjustment of spray width for different sized square areas
- Built-in Special needle for cleaning out spray nozzle
- With screen filter washer for extra gear protection



Item no.	Contents
50 99 00 02	

SPRINKLER

► METAL IMPULSE SPRINKLER WITH BUTTERFLY BASE



Item no.	Contents
50 10 40 23	

3-ARM ROTARY SPRINKLER WITH METAL WHEEL BASE

- The spray coverage is up to 24 meters diameter
- Durable rustproof finish.
- Multi spray pattern, Adjustable from stream to fine wis the base can be easily moved



Item no.	Contents
50 10 40 20	

SPRINKLER

► PLASTIC IMPULSE SPRINKLER WITH BUTTERFLY BASE



Item no.	Contents
50 10 40 24	



SPRINKLER

► 5-PATTERN MICRO SPRINKLER



Item no.	Contents
50 10 40 25	

PVC WATERING HOSES

- Characteristic& applications: this hose is light, colorful, and flexible and has good cold or hot resistance
- It is the ideal auxiliary product for garden Irrigation
- Available Temperature:-5°C+65°C



Item no.	Contents
50 10 00 01	

PVC WATERING HOSES

- Characteristic& applications: this hose is light, colorful, and flexible and has good cold or hot resistance
- It is the ideal auxiliary product for garden Irrigation
- Available Temperature:-5°C+65°C



Item no.	Contents
50 10 00 02	

SOAKER HOSES

- porous hose produced with a particular compound, which allows a uniform transpiration.
- An economic and suitable system of irrigation of flower beds, hedges and horticulture.
- Both for ground surface or for underground use at a depth of 15/20cm.
- Suitable for all types of irrigation systems or normal garden hoses.
- Different lengths available on request and for certain quantities.



Item no.	Contents
50 10 00 03	



GARDEN HOSES

- ▶ Made of PU and EVA materials
- ▶ And after special processing, the product has features in oxidation-resisting, anti-low temperature, non-toxic and high-elastic, flexible anti-oil corrosion.
- ▶ Easy to use, it is widely applicable to irrigate plantes and flowers, and also to clean cars, animals, etc.
- ▶ Easy in unwinding and storing.



Item no.	Contents
50 10 00 04	15m

GARDEN HOSES

- ▶ Made of PU and EVA materials
- ▶ And after special processing, the product has features in oxidation-resisting, anti-low temperature, non-toxic and high-elastic, flexible anti-oil corrosion.
- ▶ Easy to use, it is widely applicable to irrigate plantes and flowers, and also to clean cars, animals, etc.
- ▶ Easy in unwinding and storing.



Item no.	Contents
50 10 00 05	30m

GARDEN HOSES



Item no.	Contents
50 10 00 06	7.5m

GARDEN HOSES



Item no.	Contents
50 10 00 07	15

MULTI-PURPOSE GARDEN HOSE KIT



Item no.	Contents
50 10 00 08	

GARDEN HOSE STORER

- ▶ Store upto 30m 1/2" hose or 25m 5/8" hose.
- ▶ Easy to assemble without tools. Agility revolving connection axle avoids twisting while winding.
- ▶ Light and in high intensity for long use
- ▶ Rust and corrosion resistance.



Item no.	Contents
50 99 00 03	

GARDEN HOSE STORER

- ▶ store upto 18m 1/2" hose or 15m 5/8" hose.
- ▶ Easy to assemble without tools.
- ▶ Agility revolving connection axle avoids twisting while winding.
- ▶ Light and in high intensity for long use
- ▶ Rust and corrosion resistance.



Item no.	Contents
50 99 00 04	

GARDEN HOSE STORER

- ▶ store upto 30m 1/2" hose or 25m 5/8" hose.
- ▶ Easy to assemble without tools. Agility revolving connection axle avoids twisting while winding.
- ▶ Light and in high intensity for long use
- ▶ Rust and corrosion resistance.



Item no.	Contents
50 99 00 05	

GARDEN HOSE STORER

- ▶ store upto 30m 1/2" hose or 25m 5/8" hose.
- ▶ Easy to assemble without tools. Agility revolving connection axle avoids twisting while winding.
- ▶ Light and in high intensity for long use
- ▶ Rust and corrosion resistance.



Item no.	Contents
50 99 00 06	

AUTO HOSE REEL

▶ Hose length:20M+2M, Hose Material:PVC, hose I.D: 1/2"



Item no.	Contents
50 10 00 09	

DROP SPREADER WITH ALUMINUM HANDLE



Item no.	Contents
50 99 00 07	12L

HANDLE SPREADER



Item no.	Contents
50 99 00 08	

HOSE HANGER



Item no.	Contents
50 99 00 10	

DEFOLIATION COLLECTOR



Item no.	Contents
50 99 00 11	

FOLDING GARDEN CHAIR

▶ Open size:59.5x27x49.5cm
▶ Folding size:61x27.5x11.5



Item no.	Contents
50 99 00 12	

WATER TIMER

▶ Can be set between 0-120 minutes to shut water off automatically
▶ Spring drive mechanism, no batteries necessary, tap adaptor suits 1" & 3/4" tap



Item no.	Contents
50 99 00 13	

ELECTRONIC WATER TIMER

▶ Battery needed:9V
▶ Maximum 8 times to water your garden a day auto matically
▶ LCD screen



Item no.	Contents
50 99 00 14	

PLANT SHELF



Item no.	Contents
50 99 00 15	Height:74cm, Diameter:28cm

BRACKET



Item no.	Contents
50 99 00 16	Width:50cm, Height:160cm

HOOK



Item no.	Contents
50 99 00 17	Width:28cm, Height:30cm

HOOK

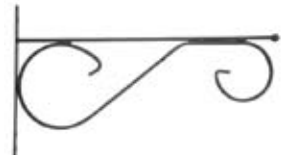

Item no.	Contents
50 99 00 18	Width:36cm, Height:21cm



HANGING BASKET



Item no.	Contents
50 99 00 19	Height:15cm, Diameter:30.5cm
50 99 00 20	Height:18cm, Diameter:30.5cm

HANGING BASKET



Item no.	Contents
50 99 00 21	Height:15cm, Diameter:30.5cm
50 99 00 22	Height:18cm, Diameter:30.5cm
50 99 00 23	Height:21cm, Diameter:40.5cm

HANGING BASKET



Item no.	Contents
50 99 00 24	Height:25.5cm, Diameter:20.5cm

SUPPORT FOR GARDEN TOOLS

► Made of extra strong plastic for stable holding



Item no.	Contents
50 99 00 25	

BORDER FENCE



Item no.	Contents
50 99 00 26	Width:45.5cm, Height:45cm

PRESSURE SPRAYER



Item no.	Contents
50 10 40 26	

PRESSURE SPRAYER

► PP,PE material



Item no.	Contents
50 10 40 27	8L

SPRAYER

► PET material



Item no.	Contents
50 10 40 29	550ML

SPRAYER

► PET material



Item no.	Contents
50 10 40 30	300ML

SPRAYER

► PP,PE material



Item no.	Contents
50 10 40 31	900ML

SPRAYER

► PP,PE material



Item no.	Contents
50 10 40 32	330ML

SPRAYER

▶ PET material



Item no.	Contents
50 10 40 33	300ML

TRIGGER SPRAYER



Item no.	Contents
50 10 40 34	

TRIGGER SPRAYER



Item no.	Contents
50 10 40 36	

MANUAL PUMP PRESSURE SPRAYER



Item no.	Contents
50 10 40 38	

TURBO SPRAYER

▶ This product can use discarded vessel(such as Coca cola bottle)



Item no.	Contents
50 10 40 39	

TURBO SPRAYER

▶ This product can use discarded vessel(such as Coca cola bottle)



Item no.	Contents
50 10 40 40	

GARDEN POTMOVER



Item no.	Contents
50 99 00 28	

22T FALT-LEAF RAKE

▶ Flat teeth,carbon steel, power coated



Item no.	Contents
50 30 20 01	

22T FALT-LEAF RAKE

▶ Round teeth, carbon steel, power coated



Item no.	Contents
50 30 20 02	

GARDEN LEAF RAKES

▶ Round teeth,galvanized



Item no.	Contents
50 30 20 03	18T

GARDEN LEAF RAKES

▶ Adjustable falt-leaf rake, galvanized



Item no.	Contents
50 30 20 04	22T





GARDEN LEAF RAKES

► Plastic material

Item no.	Contents
50 30 20 05	27T

GARDEN LEAF RAKES

► Big teeth, carbon steel power coated.

Item no.	Contents
50 30 20 06	8T

ROUND MOUTH SHOVEL

► Drop forged carbon steel,hardened, powder coated

Item no.	Contents
50 30 00 04	250X280X350mm Weight:0.9KG

TAPER SHOVEL

► Drop forged carbon steel,hardened, powder coated

Item no.	Contents
50 30 00 05	270X290X375mm Weight:1.0KG

SQUARE MOUTH SHOVEL

► Drop forged carbon steel,hardened, powder coated

Item no.	Contents
50 30 00 06	250X270X325mm Weight:1.1KG

ROUND MOUTH SHOVEL

► Drop forged carbon steel,hardened, powder coated

Item no.	Contents
50 30 00 07	270X295X350mm Weight:1.2KG

SQUARE MOUTH SHOVEL

► Drop forged carbon steel, powder coated

Item no.	Contents
50 30 00 09	26.5x33.8x102cm



CAMPING SHOVEL

► Carbon steel, powder coated.
► Purpose for the type of broad,but small volume of his work in the tourism traverse.
► Versatility is the strength of shovels and compact design;
► Teeth on the availability of silver shovels,as well as an additional protective cover provides convenient storage and transport in tourist visits.

Item no.	Contents
50 30 00 10	90X130X400mm

FOLDING SHOVEL

► Purpose for a broad type of construction,gardening,farming and other works,small in length.
► Versatility is the strength shovels design and compact;
► Teeth on the availability of silver shovels to cut roots and allows to cut grass.
► Shovel is a three-reception, which provides compactness during transportation and storage.

Item no.	Contents
50 30 00 11	

STAINLESS STEEL DIGGING FORK&SPADE

► Stainless steel

Item no.	Contents
50 30 00 12	digging fork: 290X180X110MM 2.1Kg,weight:2.1kg. spade:290x180x1120mm,weight:2.1kg.

MUCK FORK

- ▶ Drop forged carbon Steel,
- ▶ Heat treated, powder coated



Item no.	Contents
50 30 00 13	220X350X450mm Weight:730G

HOE

- ▶ Drop faged carbon steel



Item no.	Contents
50 30 00 14	2LB
50 30 00 15	3LB
50 30 00 16	3.5LB
50 30 00 17	4LB

PICK HEAD

- ▶ Chisel one end&point the other,
- ▶ Faged steel head



Item no.	Contents
50 30 00 18	1kg
50 30 00 19	1.5kg
50 30 00 20	2kg
50 30 00 21	2.5kg

GRUBBING MATTOCK

- ▶ One horizontal chisel edn &one vertical chisel end.
- ▶ Forged steel head



Item no.	Contents
50 30 00 22	4.5LB
50 30 00 23	5.5LB

PICK MATTOCK

- ▶ One horizontal chisel end&one pointed end,
- ▶ Forged steel head



Item no.	Contents
50 30 00 24	4.5LB
50 30 00 25	5LB

SPLITTING MAUL

- ▶ Forged carbon steel



Item no.	Contents
50 30 00 26	1kg, 1.5kg, 2kg 2.5kg, 3kg, 3.5kg

SPLITTING MAUL

- ▶ Plastic wedges
- ▶ Serrations hold wedge in the tree securely.
- ▶ Strong, tough and light in weight



Item no.	Contents
50 30 00 27	5.5", 8", 10", 12"





BUILDING, WOODWORKING
PAINTING TOOLS

F-CLAMP

- ▶ GS-Approval, DIN5117
- ▶ Malleable cast iron
- ▶ galvanized, serrated, nickel plated bars
- ▶ wooden handle



Item no.	Contents
53 50 00 01	50x150mm
53 50 00 02	50x200mm
53 50 00 03	50x250mm
53 50 00 04	50x300mm
53 50 00 05	120x200mm
53 50 00 06	120x300mm
53 50 00 07	120x400mm
53 50 00 08	120x500mm
53 50 00 09	120x600mm
53 50 00 10	120x800mm
53 50 00 11	120x1000mm

F-CLAMP

- ▶ Malleable cast iron
- ▶ galvanized, serrated, nickel plated bars
- ▶ wooden handle



Item no.	Contents
53 50 00 25	50x150mm
53 50 00 26	50x200mm
53 50 00 27	50x250mm
53 50 00 28	50x300mm
53 50 00 29	120x200mm
53 50 00 30	120x300mm
53 50 00 31	120x400mm
53 50 00 32	120x500mm
53 50 00 33	120x600mm
53 50 00 34	120x800mm
53 50 00 35	120x1000mm

F-CLAMP

- ▶ Fully drop forged, nickel-plated
- ▶ Brass coated thread bar



Item no.	Contents
53 50 00 48	50x150mm
53 50 00 49	50x200mm
53 50 00 50	50x250mm
53 50 00 51	50x300mm
53 50 00 52	80x300mm
53 50 00 53	120x250mm
53 50 00 54	120x300mm
53 50 00 55	120x500mm

HEAVY DUTY PUMP CLAMP

- ▶ Serrated strong bar giving more positive clamping
- ▶ Heavy duty malleable cast iron
- ▶ Jaw with strong thread bar.



Item no.	Contents
53 50 00 56	100x300mm
53 50 00 57	100x600mm
53 50 00 58	100x800mm
53 50 00 59	100x1000mm



F-CLAMP

- ▶ TUV/GS-Approval
- ▶ Extra serrated strong bar giving more positive clamping
- ▶ Additional spring ball for stopping everywhere and rivet for safety working
- ▶ Extra heavy duty malleable cast iron jaw with nickel-plated thread bar
- ▶ With strong soft TPR handle.



Item no.	Contents
53 50 00 12	50x150mm
53 50 00 13	50x200mm
53 50 00 14	50x250mm
53 50 00 15	50x300mm
53 50 00 16	80x300mm
53 50 00 17	120x250mm
53 50 00 18	120x300mm
53 50 00 19	120x500mm
53 50 00 20	120x600mm
53 50 00 21	120x800mm
53 50 00 22	120x1000mm
53 50 00 23	120x1200mm
53 50 00 24	120x1500mm

F-CLAMP

- ▶ TUV/GS-Approval, DIN 5117
- ▶ Serrated strong bar giving more positive clamping
- ▶ Heavy duty malleable cast iron; Jaw with black finished thread bar
- ▶ With strong soft TPR handle.



Item no.	Contents
53 50 00 36	50x150mm
53 50 00 37	50x200mm
53 50 00 38	50x250mm
53 50 00 39	50x300mm
53 50 00 40	80x300mm
53 50 00 41	120x250mm
53 50 00 42	120x300mm
53 50 00 43	120x500mm
53 50 00 44	120x800mm
53 50 00 45	120x1000mm
53 50 00 46	120x1200mm
53 50 00 47	120x1500mm

PROFESSIONAL F-CLAMP

- ▶ Professional quality
- ▶ Completely drop forged carbon steel
- ▶ Thread bar sand blasting and chrome coated
- ▶ Chrome plated screw bar
- ▶ Plastic anti-slip triangle handle and plastic protection
- ▶ At the end of bar with additional stopper



Item no.	Contents
53 50 00 60	60x100mm
53 50 00 61	60x200mm
53 50 00 62	60x250mm
53 50 00 63	60x300mm
53 50 00 64	80x160mm
53 50 00 65	80x300mm
53 50 00 66	100x300mm
53 50 00 67	100x450mm
53 50 00 68	100x600mm
53 50 00 69	120x300mm
53 50 00 70	120x450mm
53 50 00 71	120x600mm
53 50 00 72	120x800mm
53 50 00 73	120x1000mm

AMERICAN STYLE F-CLAMP

- ▶ Malleable cast iron
- ▶ Galvanized, serrated, nickel plated bars
- ▶ Wooden handle



Item no.	Contents
53 50 00 74	60x100mm
53 50 00 75	60x150mm
53 50 00 76	60x200mm
53 50 00 77	60x250mm
53 50 00 78	60x300mm
53 50 00 79	60x400mm
53 50 00 80	60x450mm
53 50 00 81	60x600mm
53 50 00 82	60x750mm
53 50 00 83	60x900mm
53 50 00 84	60x1200mm

F-CLAMP

- ▶ TUV/GS-Approval. DIN 5117
- ▶ Serrated strong bar giving more positive clamping
- ▶ Heavy duty malleable cast iron; Jaw with black finished thread bar
- ▶ With strong soft TPR handle.



Item no.	Contents
53 50 00 85	50x150mm
53 50 00 86	50x200mm
53 50 00 87	50x250mm
53 50 00 88	50x300mm
53 50 00 89	80x300mm
53 50 00 90	120x250mm
53 50 00 91	120x300mm
53 50 00 92	120x500mm
53 50 00 93	120x600mm
53 50 00 94	120x800mm
53 50 00 95	120x1000mm
53 50 00 96	120x1200mm
53 50 00 97	120x1500mm

MULTI-FUNCTION VICE CLAMP

- ▶ Nylon clamp body
- ▶ Quick release and easy lock



Item no.	Contents
53 50 99 01	12"/600mm

ALUMINUM BAR CLAMP

- ▶ With slides and head made of unbreakable SG iron
- ▶ Nylon clamp body
- ▶ Quick release and easy lock



Item no.	Contents
53 50 99 02	18"
53 50 99 03	24"
53 50 99 04	36"
53 50 99 05	48"

HEAVY DUTY G-CLAMP



Item no.	Contents
53 50 30 01	75mm
53 50 30 02	100mm
53 50 30 03	125mm
53 50 30 04	150mm
53 50 30 05	200mm
53 50 30 06	250mm
53 50 30 07	300mm

3 PCS G-CLAMP SET



Item no.	Contents
53 50 90 01	25mm, 50mm, 75mm

ENDLESS CLAMP

- ▶ Heavy duty, for use with 3/4 threaded pipe



Item no.	Contents
53 50 99 01	

SPRING CLAMP

- ▶ Nylon-fiberglass mixture body and P.E jaws



Item no.	Contents
53 50 50 02	100mm
53 50 50 03	150mm
53 50 50 04	220mm



BUILDING, WOODWORKING
PAINTING TOOLS

METAL SPRING CLAMP



Item no.	Contents
53 50 50 05	50mm
53 50 50 06	100mm
53 50 50 07	150mm

LONG NOSE SPRING CLAMP

- ▶ Heavy duty, for use with 3/4 threaded pipe



Item no.	Contents
53 50 50 08	100mm

DOUBLE COLOR SPRING CLAMP

- ▶ Multifunctional spring clamp allows instant opening and closing
- ▶ Soft PE jaw pads for easy holding



Item no.	Contents
53 50 50 09	3"
53 50 50 10	4"
53 50 50 11	6"
53 50 50 12	9"

SPRING CLAMP

- ▶ Sturdy engineering plastic body with dual component handle
- ▶ Moveable grip jaws automatically adapt to different working surface and ensure a safety grip
- ▶ Durable spring extended lifetime



Item no.	Contents
53 50 50 13	4"
53 50 50 14	7"

SPRING CLAMP

- ▶ Sturdy engineering plastic body
- ▶ Moveable grip jaws automatically adapt to different working surface and ensure a safety grip
- ▶ Durable spring extended life time



Item no.	Contents
53 50 50 15	2"
53 50 50 16	3"
53 50 50 17	4"
53 50 50 18	6"
53 50 50 19	9"

LARGE DEPTH SPRING CLAMP

- ▶ Deep jaws for reaching working piece far from the edge
- ▶ Long and pointed jaws for working in the narrow space
- ▶ Durable spring extended lifetime



Item no.	Contents
53 50 50 20	9"

6 PCS CLAMP SET



Item no.	Contents
53 50 50 21	2pcs quick release G-clamp
53 50 50 22	2pcs 150mm Nylon clamp
53 50 50 23	2pcs ratchet bar clamp

QUICK RATCHET BAR CLAMP

- ▶ Hard plastic body
- ▶ Black finished bar
- ▶ Soft non-marking pads
- ▶ Quick release



Item no.	Contents
53 50 70 01	6"
53 50 70 02	8"
53 50 70 03	10"
53 50 70 04	12"
53 50 70 05	16"
53 50 70 06	18"
53 50 70 07	24"
53 50 70 08	36"
53 50 70 09	48"

QUICK RATCHET BAR CLAMP

- ▶ Hard plastic body
- ▶ Black finished bar
- ▶ Soft non-marking pads and soft grip handle
- ▶ Quick release
- ▶ Bi-color handle



Item no.	Contents
53 50 70 10	6"
53 50 70 11	8"
53 50 70 12	10"
53 50 70 13	12"
53 50 70 14	16"
53 50 70 15	18"
53 50 70 16	24"
53 50 70 17	36"
53 50 70 18	48"

2 PCS RATCHET BAR CLAMP SET



Item no.	Contents
53 90 00 02	300mm

QUICK RATCHET BAR CLAMP

- ▶ Hard plastic body
- ▶ Black finished bar
- ▶ Soft non-marking pads
- ▶ Quick release



Item no.	Contents
53 50 70 20	6"
53 50 70 21	8"
53 50 70 22	10"
53 50 70 23	12"
53 50 70 24	16"
53 50 70 25	18"
53 50 70 26	24"
53 50 70 27	36"
53 50 70 28	48"

QUICK RATCHET BAR CLAMP

- ▶ Hard plastic body
- ▶ Black finished bar
- ▶ Soft non-marking pads
- ▶ Quick release



Item no.	Contents
53 50 70 29	6"
53 50 70 30	8"
53 50 70 31	10"
53 50 70 32	12"
53 50 70 33	16"
53 50 70 34	18"
53 50 70 35	24"
53 50 70 36	36"
53 50 70 37	48"

4 PCS RATCHET BAR CLAMP SET



Item no.	Contents
53 90 00 03	2pcs 100mm 2pcs 150mm

RATCHET SPRING CLAMP

- ▶ Quick release
- ▶ Swivel no-marking pads
- ▶ TPR non-slip handle



Item no.	Contents
53 50 99 06	5"
53 50 99 07	6-1/4"
53 50 99 08	9"

2 PCS RATCHET CLAMP



Item no.	Contents
53 90 00 04	9"

4 PCS RATCHET BAR CLAMP SET



Item no.	Contents
53 90 00 05	2pcs 9" 2pcs 6-1/4"



CORNOR CLAMP

- ▶ Quick release
- ▶ 180° swivel handle



Item no.	Contents
53 50 90 02	65MM

CORNOR CLAMP

- ▶ Aluminum body



Item no.	Contents
53 50 90 03	3"

QUICK ACTING CLAMP

- ▶ Strong Execution
- ▶ With release lever



Item no.	Contents
53 50 90 04	6"/150mm

WOOD CHISEL

- ▶ Hardened high quality steel
- ▶ Fully ground blade



Item no.	Contents
53 10 00 01	1/4" /6mm
53 10 00 02	5/16" /8mm
53 10 00 03	3/8" /10mm
53 10 00 04	1/2" /12mm
53 10 00 05	5/8" /16mm
53 10 00 06	3/4" /20mm
53 10 00 07	7/8" /22mm
53 10 00 08	1" /26mm
53 10 00 09	30mm
53 10 00 10	32mm

EXPERT WOOD CHISEL

- ▶ Full length bevel edged blades hardened and tempered
- ▶ With two components soft anti-slip handle
- ▶ The steel knob at the end of handle for strong striking
- ▶ Each piece has blades guard



Item no.	Contents
53 10 00 11	6mm(1/4")
53 10 00 12	8mm(5/16")
53 10 00 13	10mm(3/8")
53 10 00 14	12mm(15/32")
53 10 00 15	13mm(1/2")
53 10 00 16	14mm(9/16")
53 10 00 17	15mm(19/32")
53 10 00 18	16mm(5/8")
53 10 00 19	18mm(11/16")
53 10 00 20	19mm(3/4")
53 10 00 21	20mm(13/16")
53 10 00 22	22mm(7/8")
53 10 00 23	24mm(15/16")
53 10 00 24	25mm(1")
53 10 00 25	26mm(1-1/32")
53 10 00 26	28mm(1-1/8")
53 10 00 27	30mm(1-3/16")
53 10 00 28	32mm(1-1/4")
53 10 00 29	35mm(1-3/8")
53 10 00 30	38mm(1-1/2")



WOOD CHISEL

- ▶ Forged hardened steel blades, ground
- ▶ Plastic handle



Item no.	Contents
53 10 00 31	6mm(1/4")
53 10 00 32	8mm(5/16")
53 10 00 33	10mm(3/8")
53 10 00 34	12mm(15/32")
53 10 00 35	13mm(1/2")
53 10 00 36	14mm(9/16")
53 10 00 37	15mm(19/32")
53 10 00 38	16mm(5/8")
53 10 00 39	18mm(11/16")
53 10 00 40	19mm(3/4")
53 10 00 41	20mm(13/16")
53 10 00 42	22mm(7/8")
53 10 00 43	24mm(15/16")
53 10 00 44	25mm(1")
53 10 00 45	26mm(1-1/32")
53 10 00 46	28mm(1-1/8")
53 10 00 47	30mm(1-3/16")
53 10 00 48	32mm(1-1/4")
53 10 00 49	35mm(1-3/8")
53 10 00 50	38mm(1-1/2")

WOOD CHISEL

- ▶ Forged hardened steel blades, ground
- ▶ Transparent plastic handle



Item no.	Contents
53 10 00 51	6mm(1/4")
53 10 00 52	8mm(5/16")
53 10 00 53	10mm(3/8")
53 10 00 54	12mm(15/32")
53 10 00 55	13mm(1/2")
53 10 00 56	14mm(9/16")
53 10 00 57	15mm(19/32")
53 10 00 58	16mm(5/8")
53 10 00 59	18mm(11/16")
53 10 00 60	19mm(3/4")
53 10 00 61	20mm(13/16")
53 10 00 62	22mm(7/8")
53 10 00 63	24mm(15/16")
53 10 00 64	25mm(1")
53 10 00 65	26mm(1-1/32")
53 10 00 66	28mm(1-1/8")
53 10 00 67	30mm(1-3/16")
53 10 00 68	32mm(1-1/4")
53 10 00 69	35mm(1-3/8")
53 10 00 70	38mm(1-1/2")

WOOD CHISEL

- ▶ Forged hardened steel blades, ground
- ▶ Stubby plastic handle



Item no.	Contents
53 10 00 71	6mm(1/4")
53 10 00 72	8mm(5/16")
53 10 00 73	10mm(3/8")
53 10 00 74	12mm(15/32")
53 10 00 75	13mm(1/2")
53 10 00 76	14mm(9/16")
53 10 00 77	15mm(19/32")
53 10 00 78	16mm(5/8")
53 10 00 79	18mm(11/16")
53 10 00 80	19mm(3/4")
53 10 00 81	20mm(13/16")
53 10 00 82	22mm(7/8")
53 10 00 83	24mm(15/16")
53 10 00 84	25mm(1")
53 10 00 85	26mm(1-1/32")
53 10 00 86	28mm(1-1/8")
53 10 00 87	30mm(1-3/16")
53 10 00 88	32mm(1-1/4")
53 10 00 89	35mm(1-3/8")
53 10 00 90	38mm(1-1/2")

WOOD CHISEL

- ▶ Full length bevel edged blades hardened and tempered
- ▶ With two components soft anti-slip handle
- ▶ The steel knob at the end of handle for strong striking
- ▶ Each piece has blades guard



Item no.	Contents
53 10 10 01	6mm(1/4")
53 10 10 02	8mm(5/16")
53 10 10 03	10mm(3/8")
53 10 10 04	12mm(15/32")
53 10 10 05	13mm(1/2")
53 10 10 06	14mm(9/16")
53 10 10 07	15mm(19/32")
53 10 10 08	16mm(5/8")
53 10 10 09	18mm(11/16")
53 10 10 10	19mm(3/4")
53 10 10 11	20mm(13/16")
53 10 10 12	22mm(7/8")
53 10 10 13	24mm(15/16")
53 10 10 14	25mm(1")
53 10 10 15	26mm(1-1/32")
53 10 10 16	28mm(1-1/8")
53 10 10 17	30mm(1-3/16")
53 10 10 18	32mm(1-1/4")
53 10 10 19	35mm(1-3/8")
53 10 10 20	38mm(1-1/2")

WOOD CHISEL

- ▶ Full length bevel edged blades hardened and tempered
- ▶ With two components soft anti-slip handle
- ▶ The steel knob at the end of handle for strong striking
- ▶ Each piece has blades guard



Item no. Contents

53 10 10 21	6mm(1/4")
53 10 10 22	8mm(5/16")
53 10 10 23	10mm(3/8")
53 10 10 24	12mm(15/32")
53 10 10 25	13mm(1/2")
53 10 10 26	14mm(9/16")
53 10 10 27	15mm(19/32")
53 10 10 28	16mm(5/8")
53 10 10 29	18mm(11/16")
53 10 10 30	19mm(3/4")
53 10 10 31	20mm(13/16")
53 10 10 32	22mm(7/8")
53 10 10 33	24mm(15/16")
53 10 10 34	25mm(1")
53 10 10 35	26mm(1-1/32")
53 10 10 36	28mm(1-1/8")
53 10 10 37	30mm(1-3/16")
53 10 10 38	32mm(1-1/4")
53 10 10 39	35mm(1-3/8")
53 10 10 40	38mm(1-1/2")

3 PCS STUBBY HANDLE WOOD CHISEL

- ▶ hardened and tempered steel blades
- ▶ With two components soft handle, built-in metal striking head
- ▶ Packed in half double blister



Item no. Contents

53 90 00 08	Incl. 1/2", 3/4", 1"
-------------	----------------------

4 PCS EXPERT WOOD CHISEL

- ▶ Full length bevel edged blades hardened and tempered With two components soft anti-slip handle
- ▶ The steel at the end of handle for strong striking
- ▶ Packed in double blister



Item no. Contents

53 90 00 09	6mm(1/4") 13mm(1/2") 19mm(3/4") 25mm(1")
-------------	---------------------------------------------

6 PCS WOOD CHISEL

- ▶ Packed in double blister

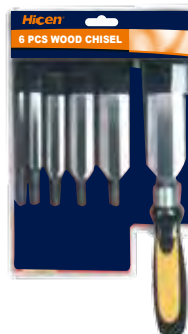

Item no. Contents

53 90 00 10	1pc Soft grip handle
53 90 00 11	5pcs removable blades

4 PCS EXPERT WOOD CHISEL

- ▶ Full length bevel edged blades hardened and tempered
- ▶ With Tri-color soft anti-slip handle
- ▶ The steel at the end of handle for strong striking
- ▶ Packed in plastic tag



Item no. Contents

53 90 00 12	Incl. 1/4", 1/2", 3/4", 1"
-------------	----------------------------

5 PCS WOOD CHISEL SET

- ▶ Packed in alu
- ▶ Bi-color handle
- ▶ Case



Item no. Contents

53 90 00 14	10,15,20,25 1pc diamond sharpening plate
-------------	------------------------------------------------

3PCS EXPERT WOOD CHISEL

- ▶ Full length bevel edged blades hardened and tempered
- ▶ With two components soft anti-slip handle
- ▶ The steel knob at the end of handle for strong striking
- ▶ Packed in double blister



Item no. Contents

53 90 00 06	13mm(1/2") 19mm(3/4") 25mm(1")
-------------	-----------------------------------

3PCS EXPERT WOOD CHISEL

- ▶ Full length bevel edged blades hardened and tempered
- ▶ With two components soft anti-slip handle
- ▶ The steel knob at the end of handle for strong striking
- ▶ Packed in aluminium case



Item no. Contents

53 90 00 07	6mm(1/4") 13mm(1/2") 19mm(3/4")
-------------	------------------------------------

6 PCS CARVING KNIFE SET

- ▶ Black finish blades
- ▶ Wooden handle



Item no. Contents

53 90 00 16	
-------------	--



BUILDING, WOODWORKING
PAINTING TOOLS

12 PCS CARVING KNIFE SET

- ▶ Black finish blades
- ▶ Wooden handle



Item no.	Contents
53 90 00 17	

12 PCS LATHE CHISELS SET

- ▶ Hardened blades, fine polished
- ▶ With fine wooden handle
- ▶ In color box



Item no.	Contents
53 90 00 18	360mm

6 PCS CARVING TOOLS

- ▶ Hardened blades, fine polished
- ▶ With fine wooden handle



Item no.	Contents
53 90 00 19	

12 PCS PALM CARVING TOOLS

- ▶ Hardened blades, fine polished
- ▶ With fine wooden handle
- ▶ Packed in wooden box double blister

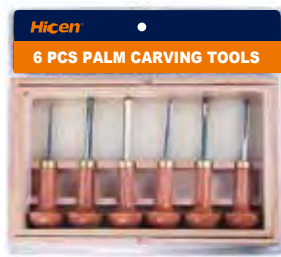

Item no.	Contents
53 90 00 20	

6 PCS CARVING TOOLS

- ▶ Hardened blades, fine polished
- ▶ With fine wooden handle
- ▶ Packed in wooden case



Item no.	Contents
53 90 00 21	

12 PCS CARVING TOOLS

- ▶ Hardened blades, fine polished
- ▶ With fine wooden handle



Item no.	Contents
53 90 00 22	

PROFESSIONAL TILE CUTTER

- ▶ For parallel cuts or parallel & angled cuts
- ▶ Die casting cutting assembly with ball bearing for tough & smooth cutting action
- ▶ Cuts up to 16mm thick
- ▶ Replaceable cutting blades: YG6X, φ22*φ6*2mm



Item no.	Contents
53 45 00 01	400mm
53 45 00 02	500mm
53 45 00 03	600mm



LIGHT DUTY TILE CUTTING MACHINE

- ▶ Light duty sheet steel base with foam cushion surface
- ▶ Aluminum supports
- ▶ Replacement tungsten carbide cutting wheel



Item no.	Contents
53 45 00 04	400mm
53 45 00 05	500mm
53 45 00 06	600mm

HEAVY DUTY TILE CUTTER

- ▶ Heavy gauge sheet steel base with foam cushion surface
- ▶ Aluminum supports
- ▶ Replacement tungsten carbide cutting wheel
- ▶ Graduated measuring aluminum square angle scale.



Item no.	Contents
53 45 00 07	400mm
53 45 00 08	500mm
53 45 00 09	600mm

3 IN 1 TILE CUTTER

- ▶ For parallel cuts, angled and hole cuts
- ▶ Die casting cutting assembly for tough cutting action
- ▶ Cuts up to 12mm thick
- ▶ Replaceable cutting blades: YG6X, φ16*φ6*3mm



Item no.	Contents
53 45 20 01	400mm-500mm
53 45 20 02	600mm-700mm

PROFESSIONAL TILE CUTTER

- ▶ For parallel cuts or parallel & angled cuts
- ▶ Die casting cutting assembly with ball bearing for tough & smooth cutting action
- ▶ Cuts up to 16mm thick
- ▶ Replaceable cutting blades:YG6X,φ22*φ6*2mm



Item no.	Contents
53 45 20 03	400mm
53 45 20 04	500mm
53 45 20 05	600mm
53 45 20 06	700mm
53 45 20 07	800mm
53 45 20 08	900mm-1200mm

PROFESSIONAL TILE CUTTER

- ▶ For parallel cuts or parallel & angled cuts
- ▶ Die casting cutting assembly with ball bearing for tough & smooth cutting action
- ▶ Cuts up to 16mm thick
- ▶ Replaceable cutting blades:YG6X,φ22*φ6*2mm



Item no.	Contents
53 45 20 09	400mm
53 45 20 10	500mm
53 45 20 11	600mm
53 45 20 12	700mm
53 45 20 13	800mm
53 45 20 14	900mm-1200mm

TOP OF RANGE PROFESSIONAL TILE CUTTER

- ▶ Aluminum base
- ▶ For parallel & angle cuts
- ▶ Angle cuts from 0°- 45°
- ▶ With fixed metric measuring guide
- ▶ Cuts up to 16mm thick
- ▶ Replaceable cutting blades:YG6X,φ12.6*φ3*3mm



Item no.	Contents
53 45 20 15	630mm

TOP OF RANGE PROFESSIONAL TILE CUTTER

- ▶ Aluminum base and support parts
- ▶ With square ruler
- ▶ For parallel & angled cuts
- ▶ Cuts up to 16mm thick
- ▶ Die casting cutting assembly with ball bearing for smooth cutting action



Item no.	Contents
53 45 20 16	400mm
53 45 20 17	500mm
53 45 20 18	600mm
53 45 20 19	700mm
53 45 20 20	800mm
53 45 20 21	900mm
53 45 20 22	1000mm
53 45 20 23	1200mm

TOP OF RANGE PROFESSIONAL TILE CUTTER

- ▶ Metal support pad on metal cuts
- ▶ For parallel & angled cuts
- ▶ Cuts up to 16mm thick
- ▶ Die casting cutting assembly with ball bearing for smooth cutting action
- ▶ Extension arm supports large tiles



Item no.	Contents
53 45 20 24	400mm
53 45 20 25	500mm
53 45 20 26	600mm
53 45 20 27	700mm
53 45 20 28	800mm
53 45 20 29	900mm
53 45 20 30	1000mm

CIRCLE TILE BORER

- ▶ Cuts circles cleanly, quickly and accurately in ceramic tiles
- ▶ Hex shanked, use with power drill
- ▶ Easy replaceable tungsten carbide blade
- ▶ With safety guard
- ▶ Drill holes from φ20mm-φ94mm



Item no.	Contents
53 45 60 01	

TILE SPACER



Item no.	Contents
53 45 60 05	

TILE SPACER



Item no.	Contents
53 45 60 06	

FLOOR TILING KIT



Item no.	Contents
53 90 00 24	Tile cutter 400mm(8105E) 200pcs 4mm tiling spacers Metal adhesive trowel Grout spreader 200mm Tile sander 180x60mm Tile sponge

FLOOR TILING KIT



Item no.	Contents
53 90 00 25	Tile cutter 300mm Spiral mixer 85x8x400mm 200pcs 2mm tiling spacers Margin trowel Tile plier 8" Grout spreader 200mm

BUILDING, WOODWORKING
PAINTING TOOLS



BUILDING, WOODWORKING
PAINTING TOOLS

WORKING BENCH

- ▶ GS-approval
- ▶ Folding size: 605x16x960mm
- ▶ Open size: 604x640x820mm



Item no.	Contents
53 60 00 01	

HEAVY DUTY HOME WORK BENCH

- ▶ Open size: 122x61x94cm(from floor to surface of table)
122x61x166cm(from floor to top of steel plate)
- ▶ Material of frame: steel tube,
- ▶ Size: 45x45mm, thickness: 1.2mm
- ▶ Material of table surface: MDF, thickness:26mm
- ▶ Material of back plate: steel plate with hanging holes, thickness: 0.8mm
- ▶ There are 4 adjustable parts at bottom of desk.
- ▶ There are 2 drawers
- ▶ Loading Capacity:300KG



Item no.	Contents
53 60 00 04	

FOLDABLE METAL SAW HORSE (2PCS)

- ▶ Open size : 1000x85x780 mm
- ▶ Working surface : 1000x85x2mm
- ▶ Tube size :26x13x1.0 mm
- ▶ Capacity: 100kg
- ▶ Gs certification
- ▶ 2pc/set(white box)



Item no.	Contents
53 60 20 01	

WORKING BENCH

- ▶ GS-approval
- ▶ Foldable and the height adjustable
- ▶ With quick release
- ▶ Square tube 30x30mm
- ▶ MDF can be turned to 15o, 30o, 45o, 60o and 75o
- ▶ Height range: 800-1050mm
- ▶ Size of the plate: 700x150x18mm
- ▶ Capacity: 100 kgs.



Item no.	Contents
53 60 00 02	

SINGLE ROLLER SUPPORT STAND

- ▶ Height range : 700-1100mm
- ▶ The diameter of the rolling :50mm,the length of the rolling 285mm
- ▶ The adjustable strut : 25x25mm
- ▶ The tube size : 30x30mm
- ▶ Capacity : 40kg
- ▶ GS certification.



Item no.	Contents
53 60 00 05	

MITER SAW STAND(ALUMINUM)

- ▶ Material: aluminum
- ▶ Open size:(1740-3750)x127x(930-1030)MM
- ▶ Height range:930-1030MM
- ▶ Length range:1740-3750MM
- ▶ Loading capacity: 100kgs
- ▶ Legs can be fold for easy storage.



Item no.	Contents
53 60 20 02	

WORKING BENCH

- ▶ Overall Dimensions:660x640x850mm
- ▶ Diameter of tube:28mm
- ▶ Cross cut up to 265mm
- ▶ With quick release for work top
- ▶ Loading Capacity:100kgs
- ▶ GS certification



Item no.	Contents
53 60 00 03	

TRIPLE ROLLER ADJUSTABLE SUPPORT STAND

- ▶ Folding size : 640x145x915mm
- ▶ Height range : 700-1100mm
- ▶ Open size : 640x541x(700-1100)mm
- ▶ The size of the rising strut : 25x25x1.8mm
- ▶ The diameter of the rolling : 50mm and the length of the rolling 500mm



Item no.	Contents
53 60 00 06	

FOLDABLE AXLE STAND

- ▶ Loading capacity :100kg
- ▶ Width range :800-1080mm
- ▶ Height range :710-910mm
- ▶ Tube size :25x25x1.6mm
- ▶ Strut size:20x20x1.2mm
- ▶ TUV/GS certificate



Item no.	Contents
53 60 20 03	

STEEL WORK STATION

- ▶ The upper layer size :51x46cm
- ▶ The middle layer size :61.5x56.4cm
- ▶ Overall dimensions: 51x46x (68.6-83.8)cm
- ▶ Height adjust from 68.6-83.8cm
- ▶ Heavy-gauge steel construction (support up to 100kgs)



Item no.	Contents
53 99 00 01	

STEEL MULTIFUNCTIONAL SCAFFOLD

- ▶ Open size:1870×740×1820 mm
- ▶ Tube size:38×38×2.0mm
- ▶ Material: steel
- ▶ Four units of 5" rubber caster with brake system
- ▶ Loading capacity: 450kgs



Item no.	Contents
53 60 00 07	

BRICKLAYING TROWEL

- ▶ Steel blade, welded and hardened
- ▶ Wooden handle



Item no.	Contents
53 30 00 01	140mm
53 30 00 02	160mm
53 30 00 03	180mm
53 30 00 04	200mm
53 30 00 05	220mm

BRICKLAYING TROWEL

- ▶ Steel blade, welded and hardened
- ▶ Wooden handle



Item no.	Contents
53 30 00 06	125mm
53 30 00 07	150mm
53 30 00 08	180mm
53 30 00 09	200mm
53 30 00 10	225mm

BRICKLAYING TROWEL

- ▶ Steel blade, welded and hardened
- ▶ Wooden handle



Item no.	Contents
53 30 00 11	5"
53 30 00 12	6"
53 30 00 13	7"
53 30 00 14	8"

BRICKLAYING TROWEL

- ▶ Steel blade, welded and hardened
- ▶ Wooden handle



Item no.	Contents
53 30 00 15	5"
53 30 00 16	6"
53 30 00 17	7"
53 30 00 18	8"
53 30 00 19	9"
53 30 00 20	10"
53 30 00 21	11"



BRICKLAYING TROWEL

- ▶ Steel blade, welded and hardened
- ▶ Wooden handle



Item no.	Contents
53 30 00 22	5"
53 30 00 23	6"
53 30 00 24	7"
53 30 00 25	8"
53 30 00 26	9"
53 30 00 27	10"
53 30 00 28	11"
53 30 00 29	12"

BRICKLAYING TROWEL

- ▶ Steel blade, welded and hardened
- ▶ Wooden handle



Item no.	Contents
53 30 00 30	140mm
53 30 00 31	160mm
53 30 00 32	180mm
53 30 00 33	190mm
53 30 00 34	200mm
53 30 00 35	210mm
53 30 00 36	220mm
53 30 00 37	240mm

BRICKLAYING TROWEL

- ▶ Steel blade, welded and hardened
- ▶ Wooden handle



Item no.	Contents
53 30 00 38	160mm
53 30 00 39	180mm
53 30 00 40	190mm
53 30 00 41	200mm
53 30 00 42	210mm
53 30 00 43	220mm
53 30 00 44	240mm
53 30 00 45	260mm

BUILDING, WOODWORKING
PAINTING TOOLS



BUILDING, WOODWORKING
PAINTING TOOLS

BRICKLAYING TROWEL

- ▶ Steel blade, welded and hardened
- ▶ Wooden handle



Item no.	Contents
53 30 00 46	128x67mm

BRICKLAYING TROWEL

- ▶ Steel blade, welded and hardened
- ▶ Wooden handle



Item no.	Contents
53 30 00 76	155mm
53 30 00 77	170mm
53 30 00 78	185mm

BRICKLAYING TROWEL

- ▶ Steel blade, welded and hardened
- ▶ Wooden handle



Item no.	Contents
53 30 10 02	

BRICKLAYING TROWEL

- ▶ Steel blade, welded and hardened
- ▶ Wooden handle



Item no.	Contents
53 30 00 47	155mm
53 30 00 48	170mm
53 30 00 49	185mm

BRICKLAYING TROWEL

- ▶ Steel blade, welded and hardened
- ▶ Wooden handle



Item no.	Contents
53 30 00 50	120x110mm

BRICKLAYING TROWEL

- ▶ Steel blade, welded and hardened
- ▶ Wooden handle



Item no.	Contents
53 30 10 03	

BRICKLAYING TROWEL

- ▶ Steel blade, welded and hardened
- ▶ Wooden handle



Item no.	Contents
53 30 00 70	155mm
53 30 00 71	170mm
53 30 00 72	185mm

BRICKLAYING TROWEL

- ▶ Steel blade, welded and hardened
- ▶ Wooden handle



Item no.	Contents
53 30 00 79	

BRICKLAYING TROWEL

- ▶ Steel blade, welded and hardened
- ▶ Wooden handle



Item no.	Contents
53 30 10 04	

BRICKLAYING TROWEL

- ▶ Steel blade, welded and hardened
- ▶ Wooden handle



Item no.	Contents
53 30 00 73	155mm
53 30 00 74	170mm
53 30 00 75	185mm

BRICKLAYING TROWEL

- ▶ Steel blade, welded and hardened
- ▶ Wooden handle



Item no.	Contents
53 30 10 01	

BRICKLAYING TROWEL

- ▶ Steel blade, welded and hardened
- ▶ Wooden handle



Item no.	Contents
53 30 10 05	

BRICKLAYING TROWEL

- ▶ Steel blade, welded and hardened
- ▶ Wooden handle



Item no.	Contents
53 30 10 06	

BRICKLAYING TROWEL

- ▶ Steel blade, welded and hardened
- ▶ Wooden handle



Item no.	Contents
53 30 00 53	5"

PLASTERING TROWEL

- ▶ Stainless steel blades
- ▶ Plastic handle



Item no.	Contents
53 30 20 01	280x120mm
53 30 20 02	280x130mm

BRICKLAYING TROWEL

- ▶ Steel blade, welded and hardened
- ▶ Wooden handle



Item no.	Contents
53 30 10 07	

BRICKLAYING TROWEL

- ▶ Steel blade, welded and hardened
- ▶ Wooden handle



Item no.	Contents
53 30 00 54	10mm

PLASTERING TROWEL

- ▶ Plastic blade
- ▶ Plastic handle



Item no.	Contents
53 30 20 03	280x130mm
53 30 20 04	280x140mm

BRICKLAYING TROWEL

- ▶ Steel blade, welded and hardened
- ▶ Wooden handle



Item no.	Contents
53 30 00 51	5"x3/8"mm

BRICKLAYING TROWEL

- ▶ Steel blade, welded and hardened
- ▶ Bi-color plastic handle



Item no.	Contents
53 30 00 55	140mm
53 30 00 56	160mm
53 30 00 57	180mm
53 30 00 58	200mm
53 30 00 59	220mm

PLASTERING TROWEL

- ▶ Steel blade hardened
- ▶ Wooden handle



Item no.	Contents
53 30 20 05	280x110mm
53 30 20 06	280x130mm

BRICKLAYING TROWEL

- ▶ Steel blade, welded and hardened
- ▶ Wooden handle



Item no.	Contents
53 30 00 52	5"x2"mm

BRICKLAYING TROWEL

- ▶ Steel blade, welded and hardened
- ▶ Wooden handle



Item no.	Contents
53 30 00 61	180mm

PLASTERING TROWEL

- ▶ Stainless steel blades
- ▶ Plastic handle



Item no.	Contents
53 30 20 07	280x115mm
53 30 20 08	280x120mm
53 30 20 09	280x125mm
53 30 20 10	280x130mm

PLASTERING TROWEL

- ▶ Stainless steel blades
- ▶ Wooden handle



Item no.	Contents
53 30 20 11	400x130mm
53 30 20 12	480x130mm
53 30 20 12	600x130mm

ALUMINUM FLOAT

- ▶ Stainless steel blades
- ▶ Wooden handle



Item no.	Contents
53 30 20 14	210x135mm
53 30 20 15	235x105mm

PLASTERING TROWEL

- ▶ Stainless steel blades
- ▶ Bi-color soft plastic handle



Item no.	Contents
53 30 20 16	280x120mm
53 30 20 17	280x125mm
53 30 20 18	280x130mm

PLASTERING TROWEL

- ▶ Stainless steel blades
- ▶ Bi-color soft plastic handle



Item no.	Contents
53 30 20 19	280x120mm
53 30 20 20	280x125mm
53 30 20 21	280x130mm

SQUARE SCRAPER LONG WOODEN HANDLE

- ▶ Steel blade hardened
- ▶ Wooden handle



Item no.	Contents
53 30 20 22	100mm
53 30 20 23	120mm
53 30 20 24	140mm
53 30 20 25	160mm
53 30 20 26	180mm
53 30 20 27	200mm
53 30 20 28	240mm

SQUARE SCRAPER

- ▶ Stainless steel blades
- ▶ With aluminum clip
- ▶ Wooden handle



Item no.	Contents
53 30 20 29	6"
53 30 20 30	8"
53 30 20 31	10"
53 30 20 32	12"
53 30 20 33	14"
53 30 20 34	16"
53 30 20 35	18"
53 30 20 36	20"
53 30 20 37	24"

SQUARE SCRAPER

- ▶ Stainless steel blades
- ▶ Plastic handle



Item no.	Contents
53 30 20 38	40mm
53 30 20 39	60mm
53 30 20 40	80mm
53 30 20 41	100mm
53 30 20 42	150mm
53 30 20 43	200mm
53 30 20 44	250mm
53 30 20 45	300mm
53 30 20 46	350mm
53 30 20 47	400mm
53 30 20 48	450mm
53 30 20 49	600mm

SQUARE SCRAPER

- ▶ Stainless steel blades
- ▶ Bi-color plastic handle



Item no.	Contents
53 30 20 50	200mm
53 30 20 51	250mm
53 30 20 52	300mm
53 30 20 53	350mm
53 30 20 54	450mm

SCRAPER WITH HAMMER KNOB

- ▶ Stainless steel blades
- ▶ Bi-color plastic handle with hammer knob



Item no.	Contents
53 30 20 55	6"
53 30 20 56	8"
53 30 20 57	10"
53 30 20 58	12"
53 30 20 59	14"

CORNER TROWEL

- ▶ Stainless steel blades
- ▶ Wooden handle



Item no.	Contents
53 30 20 60	80x60x60mm
53 30 20 61	110x75x75mm

CORNER TROWEL

- ▶ Steel blades
- ▶ Wooden handle



Item no.	Contents
53 30 20 62	126x65x65mm

PU FLOAT

- ▶ Material is PU



Item no.	Contents
53 30 30 01	240x120x15mm 280x140x15mm 480x240x15mm 420x220x16mm

PU FLOAT

- ▶ Material is PU



Item no.	Contents
53 30 30 02	250x250x15mm

PU FLOAT

- ▶ Material is PU



Item no.	Contents
53 30 30 03	1200x120mm

PLASTERING TROWELS

- ▶ Material is wood



Item no.	Contents
53 30 30 04	14"x3.5" 16"x3.5"

CORNER TROWEL

- ▶ Steel blades
- ▶ Wooden handle



Item no.	Contents
53 30 30 05	126x65x65mm

CORNER TROWEL

- ▶ Steel blades
- ▶ Wooden handle



Item no.	Contents
53 30 30 06	3"x6"

CORNER TROWEL

- ▶ Stainless steel blades
- ▶ Wooden handle



Item no.	Contents
53 30 30 07	50x75mm

PLASTERING TROWEL

- ▶ ABS board
- ▶ Wooden handle



Item no.	Contents
53 30 30 08	270x180mm

CORNER TROWEL

- ▶ 420# Stainless steel blade
- ▶ Wooden handle



Item no.	Contents
53 30 30 09	110x75x75mm 80x60x60mm

CORNER TROWEL

- ▶ 420# Stainless steel blade
- ▶ Wooden handle



Item no.	Contents
53 30 30 10	110x75x75mm 80x60x60mm

CORNER TROWEL

- ▶ 420# Stainless steel blade
- ▶ Wooden handle



Item no.	Contents
53 30 30 11	80x20x20mm

BRICKLAYING TROWEL

- ▶ 50# Stainless steel blade with EVA + rubber
- ▶ Wooden handle



Item no.	Contents
53 30 30 12	5"x2" 6"x2"



RUBBER SCRAPER

- ▶ Rubber blades
- ▶ Wooden handle



Item no. Contents

53 30 20 64	150mm
53 30 20 65	200mm
53 30 20 66	250mm
53 30 20 67	300mm
53 30 20 68	400mm

SCRAPER

- ▶ steel blades
- ▶ Wooden handle

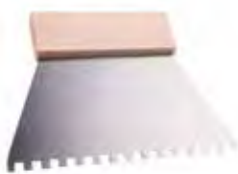

Item no. Contents

53 30 20 69	120mm
53 30 20 70	180mm
53 30 20 71	250mm

PUTTY BOWL



Item no. Contents

53 30 99 01	93x120x70mm
-------------	-------------

RUBBER SANDING BLOCK



Item no. Contents

53 30 99 02	125x68mm
-------------	----------

PLUMB BOB



Item no. Contents

53 40 40 01	350g
-------------	------

PLUMB BOB



Item no. Contents

53 40 40 02	500g
-------------	------

PLUMB BOB



Item no. Contents

53 40 40 03	100g
53 40 40 04	300g
53 40 40 05	500g

PLUMB BOB



Item no. Contents

53 40 40 06	100g
53 40 40 07	300g

PLUMB BOB

- ▶ ABS plastic parts ,45#steel body,chrome plated
- ▶ With magnet
- ▶ Packed in double blister



Item no. Contents

53 30 30 15	3m / 5m
-------------	---------

PLUMB BOB

- ▶ ABS plastic parts ,45#steel body,chrome plated
- ▶ Packed in sliding card



Item no. Contents

53 30 30 16	300g / 400g
-------------	-------------

PLUMB BOB

- ▶ Iron body,color-zinc plated
- ▶ Packed in double blister



Item no. Contents

53 30 30 17	500g / 700g
-------------	-------------

PLUMB BOB

- ▶ 45#steel body,chrome plated
- ▶ Packed in color box



Item no. Contents

53 30 30 18	400g
-------------	------

CARPENTER PENCIL

► Oval



Item no.	Contents
53 40 20 01	180mm
53 40 20 02	250mm

CARPENTER PENCIL

► Rectangle



Item no.	Contents
53 40 20 03	180mm

BI-COLOR CARPENTER PENCIL

► Hexagon



Item no.	Contents
53 40 20 04	180mm

CHALK LINE

► Aluminum case



Item no.	Contents
53 40 00 01	30mm

CHALK LINE

► Aluminum case



Item no.	Contents
53 40 00 02	30mm

CHALK LINE SET

► Double blister packed



Item no.	Contents
53 90 00 26	1pc 30m chalk line, plastic case wrapped with rubber 1 bottle powder 115g

CHALK LINE SET

► Double blister packed



Item no.	Contents
53 90 00 27	1pc 30m chalk line, 3:1 gear ratio for quick rolling back, plastic case with rubber for soft and comfortable case 2 bottles powder, 50g/bottle, red/blue

WOOD PLANE

► Plane body is made of quality wood
► Hardening heat-treated blade, hardness:550-580



Item no.	Contents
53 20 00 01	200X40mm
53 20 00 02	235x50mm

WOOD PLANE

► Plane body is made of quality wood
► Hardening heat-treated blade, hardness:550-580



Item no.	Contents
53 20 00 03	250x25mm

WOOD PLANE

► Plane body is made of quality wood
► Hardening heat-treated blade, hardness:550-580



Item no.	Contents
53 20 00 04	185x44mm
53 20 00 05	235x44mm
53 20 00 06	280x44mm
53 20 00 07	355x44mm

WOOD PLANE

► Plane body is made of quality wood
► Hardening heat-treated blade, hardness:550-580



Item no.	Contents
53 20 00 08	230x40mm

MARKING AND MORTICE GAUGE

► Made of beechwood with hardened spurs and brass slide



Item no.	Contents
53 20 00 09	

WOOD CARVING CHISEL



Item no.	Contents
53 20 80 01	145mm

SMOOTHING PLANE

- ▶ Grey cast iron body with precision milled base and faces.
- ▶ Fully adjustable high carbon steel hardened, tempered and fully grounded.
- ▶ Wooden handle and guidance knob for user comfort.
- ▶ Supplied complete with a spare iron.



Item no.	Contents
53 20 20 01	240x44mm
53 20 20 02	250x50mm
53 20 20 03	355x50mm

LIGHT BENCH PLANE

- ▶ Pressed steel body with high carbon steel.



Item no.	Contents
53 20 20 04	235x44mm
53 20 20 05	250x50mm
53 20 20 06	355x50mm

BLOCK PLANE

- ▶ Pressed steel body with high carbon steel.



Item no.	Contents
53 20 20 07	135x33mm
53 20 20 08	160x42mm

ADJUSTABLE SPOLE SHAVE

- ▶ With cast iron, high carbon steel blade, flat face pattern.



Item no.	Contents
53 20 20 09	135x33mm
53 20 20 10	160x42mm

SPOKE SHAVE

- ▶ With cast iron, high carbon steel blade, flat face pattern.



Item no.	Contents
53 20 20 11	220x44mm

2PCS WOOD PLANE SET

- ▶ Pressed steel body with high carbon steel.



Item no.	Contents
53 90 00 28	235x44mm 160x42mm

SCRIBER CENTER PUNCH



Item no.	Contents
53 10 40 01	13.5mm

BLADE FOR BIRD PLANE



Item no.	Contents
53 20 80 02	2"

BLADE FOR BIRD PLANE



Item no.	Contents
53 20 80 03	1-3/4"

BLADE FOR TRIMMING PLANE



Item no.	Contents
53 20 80 04	1-3/4"

BLADE FOR BENCH PLANE



Item no.	Contents
53 20 80 05	1-3/4"

BLADE FOR BIRD PLANE



Item no.	Contents
53 20 80 06	1-1/2"
53 20 80 07	1-3/4"
53 20 80 08	2"
53 20 80 09	2-1/4"

BLOCK PLANER

- ▶ Strongly-molded plastic (ABS) body
- ▶ Thumb screw for easy replacement
- ▶ Perfect for smoothing uneven surfaces on non-ferrous metals, gypsum, wood, plastics and other boards



Item no.	Contents
53 20 20 12	140x40mm
53 20 20 13	250x40mm

BLOCK PLANER

- ▶ Strongly-molded plastic(ABS) body
- ▶ Featured by Simple, click-on blade replacement
- ▶ Applicable for stripping paint or smoothing uneven surfaces in tricky places



Item no.	Contents
53 20 20 14	60x40mm

BLOCK PLANER

- ▶ Die cast Zinc alloy body
- ▶ Strongly-molded plastic (ABS) handle
- ▶ Resilient enough for smoothing uneven surfaces on non-ferrous metals, gypsum, wood, plastics and other boards



Item no.	Contents
53 20 20 15	250x40mm

BLOCK PLANER

- ▶ Die cast Zinc alloy body
- ▶ Strongly-molded plastic (ABS/TPR) handle, Turnable
- ▶ Resilient enough for smoothing uneven surfaces on non-ferrous metals, gypsum, wood, plastics and other boards



Item no.	Contents
53 20 20 16	250x40mm

BLOCK PLANER

- ▶ Die cast Zinc alloy body
- ▶ Strongly-molded plastic (ABS) handle
- ▶ Resilient enough for smoothing uneven surfaces on non-ferrous metals, gypsum, wood, plastics and other boards



Item no.	Contents
53 20 20 17	250x40mm

PLANER FILE

- ▶ Die cast Zinc alloy body
- ▶ Swiveling molded plastic (ABS) handle offers this tool with both file and plane function.
- ▶ Resilient enough for smoothing uneven surfaces on non-ferrous metals, gypsum, wood, plastics and other boards



Item no.	Contents
53 20 20 18	250x40mm

COMBINATION RASP

- ▶ Optional die cast Zinc or Aluminum alloy body
- ▶ Strongly molded plastic (ABS) handle
- ▶ Perfect for smoothing uneven surfaces on non-ferrous metals, gypsum, wood, plastics and other boards



Item no.	Contents
53 20 20 19	250x40mm

BLOCK PLANER

- ▶ Optional die cast Zinc or Aluminum alloy body
- ▶ Perfect for smoothing uneven surfaces on non-ferrous metals, gypsum, wood, plastics and other boards



Item no.	Contents
53 20 20 20	140x40mm

REPLACEMENT PLANER BLOCK

- ▶ 65Mn hardened steel quality



Item no.	Contents
53 20 20 21	60x40mm
53 20 20 22	140x40mm
53 20 20 23	250x40mm

WOOD PLANE

- ▶ 65Mn hardened steel quality



Item no.	Contents
53 20 20 24	Φ16x250mm

HAND DRILL



Item no.	Contents
53 70 00 01	1/4"; 3/8"

BREAST DRILL



Item no.	Contents
53 70 00 02	3/8"; 1/2"

RATCHET BRACES



Item no.	Contents
53 70 00 03	10"; 12"



CHISEL

BUILDING, WOODWORKING
PAINTING TOOLS

CONCRETE PUNCH

- ▶ chrome vanadium steel, hardened and tempered
- ▶ powder coated or black finished



Item no.	Pointsize	Shanksize	Length
53 10 20 01	5/32" (4mm)	5/8" (16mm)	8" (203mm)
53 10 20 02	5/32" (4mm)	5/8" (16mm)	10" (254mm)
53 10 20 03	5/32" (4mm)	5/8" (16mm)	12" (305mm)
53 10 20 04	5/32" (4mm)	3/4" (19mm)	8" (203mm)
53 10 20 05	5/32" (4mm)	3/4" (19mm)	10" (254mm)
53 10 20 06	5/32" (4mm)	3/4" (19mm)	12" (305mm)
53 10 20 07	5/32" (4mm)	3/4" (19mm)	6" (406mm)

MASON CHISEL

- ▶ Chrome vanadium steel, hardened and tempered,
- ▶ Powder coated or black finished



Item no.	Pointsize	Shanksize	Length
53 10 20 43	1-3/4" (44mm)	3/4" (19mm)	8-1/2" (215mm)
53 10 20 44	2-3/4" (70mm)	3/4" (19mm)	8-1/2" (215mm)

COLD CHISEL

- ▶ Chrome vanadium steel, hardened and tempered
- ▶ Powder coated or black finished



Item no.	Pointsize	Shanksize	Length
53 10 20 08	1/4" (6mm)	1/4" (6mm)	5" (127mm)
53 10 20 09	1/4" (6mm)	1/4" (6mm)	6" (152mm)
53 10 20 10	1/4" (6mm)	1/4" (6mm)	8" (203mm)
53 10 20 11	5/16" (8mm)	1/4" (6mm)	6" (152mm)
53 10 20 12	5/16" (8mm)	1/4" (6mm)	8" (203mm)
53 10 20 13	3/8" (10mm)	5/16" (6mm)	5-9/16" (203mm)
53 10 20 14	3/8" (10mm)	5/16" (6mm)	6" (152mm)
53 10 20 15	3/8" (10mm)	5/16" (6mm)	8" (203mm)
53 10 20 16	3/8" (10mm)	5/16" (16mm)	10" (254mm)
53 10 20 17	1/2" (13mm)	3/8" (10mm)	6" (152mm)
53 10 20 18	1/2" (13mm)	3/8" (10mm)	8" (203mm)
53 10 20 19	1/2" (13mm)	3/8" (10mm)	10" (254mm)
53 10 20 20	1/2" (13mm)	3/8" (10mm)	12" (305mm)
53 10 20 21	5/8" (16mm)	1/2" (13mm)	6" (152mm)
53 10 20 22	5/8" (16mm)	1/2" (13mm)	6-3/4" (172mm)
53 10 20 23	5/8" (16mm)	1/2" (13mm)	8" (203mm)
53 10 20 24	5/8" (16mm)	1/2" (13mm)	10" (254mm)
53 10 20 25	5/8" (16mm)	1/2" (19mm)	12" (305mm)
53 10 20 26	3/4" (19mm)	5/8" (19mm)	6" (152mm)
53 10 20 27	3/4" (19mm)	5/8" (19mm)	6-7/8" (175mm)
53 10 20 28	3/4" (19mm)	5/8" (16mm)	8" (203mm)
53 10 20 29	3/4" (19mm)	5/8" (16mm)	10" (254mm)
53 10 20 30	3/4" (19mm)	5/8" (16mm)	12" (305mm)
53 10 20 31	7/8" (22mm)	3/4" (19mm)	8" (203mm)
53 10 20 32	7/8" (22mm)	3/4" (19mm)	10" (254mm)
53 10 20 33	7/8" (22mm)	3/4" (19mm)	12" (305mm)
53 10 20 34	7/8" (22mm)	3/4" (19mm)	16" (203mm)
53 10 20 35	7/8" (22mm)	3/4" (16mm)	18" (457mm)
53 10 20 36	7/8" (22mm)	3/4" (16mm)	20" (508mm)
53 10 20 37	1" (25mm)	3/4" (16mm)	8" (203mm)
53 10 20 38	1" (25mm)	3/4" (19mm)	10" (254mm)
53 10 20 39	1" (25mm)	3/4" (19mm)	12" (305mm)
53 10 20 40	1" (25mm)	3/4" (19mm)	16" (406mm)
53 10 20 41	1" (25mm)	3/4" (19mm)	18" (457mm)
53 10 20 42	1" (25mm)	3/4" (19mm)	20" (508mm)

FLOOR CHISEL

- ▶ Chrome vanadium steel, hardened and tempered,
- ▶ Powder coated or black finished



Item no.	Pointsize	Shanksize	Length
53 10 20 45	2-1/4" (57mm)	3/4" (19mm)	10" (254mm)
53 10 20 46	3" (76mm)	3/4" (19mm)	11" (280mm)

BRICK CHISEL

- ▶ Chrome vanadium steel, hardened and tempered,
- ▶ Powder coated or black finished



Item no.	Pointsize	Shanksize	Length
53 10 20 47	3" (76mm)	3/4" (19mm)	8-1/2" (215mm)
53 10 20 48	4" (100mm)	3/4" (19mm)	8-1/2" (215mm)

UTILITY CHISEL

- ▶ Chrome vanadium steel, hardened and tempered,
- ▶ Powder coated or black finished



Item no.	Pointsize	Shanksize	Length
53 10 20 49	1-1/4" (32mm)	1" x3/8"	12" (300mm)

PIN CHISEL

- ▶ Chrome vanadium steel, hardened and tempered
- ▶ Powder coated or black finished



Item no.	Pointsize	Shanksize	Length
53 10 20 50	1/16" (1.5mm)	1/4" (6mm)	6" (152mm)
53 10 20 51	1/8" (3mm)	5/16" (8mm)	6" (152mm)
53 10 20 52	5/32" (4mm)	5/16" (8mm)	6" (152mm)
53 10 20 53	3/16" (5mm)	5/16" (8mm)	6" (152mm)
53 10 20 54	1/4" (6mm)	3/8" (10mm)	6" (152mm)
53 10 20 55	5/16" (8mm)	3/8" (10mm)	6" (152mm)



CENTER PUNCH

- ▶ Chrome vanadium steel, hardened and tempered
- ▶ Powder coated or black finished



Item no.	Pointsize	Shanksize	Length
53 10 20 56	1/4" (6mm)	3/8" (10mm)	4" (100mm)
53 10 20 57	5/16" (8mm)	3/8" (10mm)	4-1/2"(152mm)
53 10 20 58	3/8" (10mm)	1/2" (13mm)	5" (125mm)
53 10 20 59	1/2" (13mm)	5/8" (16mm)	5-1/2"(140mm)

SOLID PUNCH

- ▶ Chrome vanadium steel, hardened and tempered,
- ▶ Powder coated or black finished



Item no.	Pointsize	Shanksize	Length
53 10 20 60	3/32" (6mm)	3/8" (10mm)	5-1/2"(140mm)

CONCRETE PUNCH

- ▶ Chrome vanadium steel, hardened and tempered
- ▶ Powder coated or black finished
- ▶ With heavy duty two components anti-slip hand protection grip



Item no.	Pointsize	Shanksize	Length
53 10 20 61	5/32" (4mm)	5/8" (16mm)	8" (203mm)
53 10 20 62	5/32" (4mm)	5/8" (16mm)	10" (254mm)
53 10 20 63	5/32" (4mm)	5/8" (16mm)	10" (254mm)
53 10 20 64	5/32" (4mm)	5/8" (16mm)	12" (305mm)
53 10 20 65	5/32" (4mm)	3/4" (19mm)	10" (254mm)
53 10 20 66	5/32" (4mm)	3/4" (19mm)	12" (305mm)
53 10 20 67	5/32" (4mm)	3/4" (19mm)	16" (406mm)

COLD CHISEL

- ▶ Chrome vanadium steel, hardened and tempered
- ▶ Powder coated or black finished
- ▶ With heavy duty two components anti-slip hand protection grip



Item no.	Pointsize	Shanksize	Length
53 10 20 68	3/8" (10mm)	5/16" (8mm)	7" (178mm)
53 10 20 69	1/2" (13mm)	3/8" (10mm)	7" (178mm)
53 10 20 70	5/8" (16mm)	1/2" (12mm)	7" (178mm)
53 10 20 71	5/8" (16mm)	1/2" (12mm)	8" (203mm)
53 10 20 72	3/4" (19mm)	5/8" (16mm)	8" (203mm)
53 10 20 73	5/8" (16mm)	1/2" (12mm)	10" (254mm)
53 10 20 74	3/4" (19mm)	5/8" (16mm)	10" (254mm)
53 10 20 75	3/4" (19mm)	5/8" (16mm)	10" (254mm)
53 10 20 76	3/4" (19mm)	5/8" (16mm)	12" (305mm)
53 10 20 77	7/8" (22mm)	3/4" (19mm)	10" (254mm)
53 10 20 78	7/8" (22mm)	3/4" (19mm)	12" (305mm)
53 10 20 79	7/8" (22mm)	3/4" (19mm)	16" (406mm)
53 10 20 80	1" (25mm)	3/4" (19mm)	10" (254mm)
53 10 20 81	1" (25mm)	3/4" (19mm)	12" (305mm)
53 10 20 82	1" (25mm)	3/4" (19mm)	16" (406mm)

COLD CHISEL

- ▶ Chrome vanadium steel, hardened and tempered
- ▶ Powder coated or black finished
- ▶ With heavy duty two components anti-slip hand protection grip



Item no.	Pointsize	Shanksize	Length
53 10 20 83	1-3/4"(44mm)	3/4" (19mm)	8-1/2" (216mm)
53 10 20 84	2-3/4"(70mm)	3/4" (19mm)	8-1/2" (216mm)

FLOOR CHISEL

- ▶ Chrome vanadium steel, hardened and tempered
- ▶ Powder coated or black finished
- ▶ With heavy duty two components anti-slip hand protection grip



Item no.	Pointsize	Shanksize	Length
53 10 20 85	2-1/4"(57mm)	3/4" (19mm)	10" (254mm)
53 10 20 86	3"(76mm)	3/4" (19mm)	11" (280mm)

BRICK CHISEL

- ▶ Chrome vanadium steel, hardened and tempered
- ▶ Powder coated or black finished
- ▶ With heavy duty two components anti-slip hand protection grip



Item no.	Pointsize	Shanksize	Length
53 10 20 87	3"(76mm)	3/4" (19mm)	8-1/2" (216mm)
53 10 20 88	4"(102mm)	3/4" (19mm)	8-1/2" (216mm)

COLD CHISEL

- ▶ Chrome vanadium steel, hardened and tempered
- ▶ Powder coated or black finished
- ▶ With heavy duty anti-slip hand protection grip



Item no.	Pointsize	Shanksize	Length
53 10 20 89	Point	16mm	250mm
53 10 20 90	Point	18mm	300mm
53 10 20 91	Flat	16mm	250mm
53 10 20 92	Flat	18mm	300mm

POINTED CHISEL

- ▶ DIN 7256
- ▶ Drop forged chrome vanadium steel, heat treated
- ▶ Hardened head to HRC54—58
- ▶ Painting finish for increased visibility
- ▶ Used for shaping, cutting, and chipping



Item no.	sxL(mm)
53 20 30 01	8x200
53 20 30 02	10x150
53 20 30 03	10x200
53 20 30 04	16x200
53 20 30 05	16x250
53 20 30 06	16x300
53 20 30 07	16x350
53 20 30 08	16x400
53 20 30 09	18x300
53 20 30 10	18x350
53 20 30 11	18x400
53 20 30 12	20x300
53 20 30 13	20x350
53 20 30 14	20x400

FLAT COLD CHISEL

- ▶ **DIN 6453**
- ▶ Drop forged chrome vanadium steel, heat treated
- ▶ Hardened head to HRC54—58
- ▶ Painting finish for increased visibility
- ▶ Used for shaping, cutting, and chipping

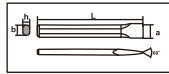

Item no.	axb x hxL (mm)
53 20 30 15	12x11x7x150
53 20 30 16	12x11x7x200
53 20 30 17	15x14x9x125
53 20 30 18	15x14x9x150
53 20 30 19	18x17x11x150
53 20 30 20	18x17x11x165
53 20 30 21	18x17x11x175
53 20 30 22	18x17x11x200
53 20 30 23	25x17x11x250
53 20 30 24	25x17x11x300
53 20 30 25	30x20x12x150
53 20 30 26	26x20x12x175
53 20 30 27	26(30)x20x12x200
53 20 30 28	26(30)x20x12x250
53 20 30 29	26(31,33)x20x12x300
53 20 30 30	24x23x13x200
53 20 30 31	25x23x13x250
53 20 30 32	26x23x13x300
53 20 30 33	29x23x13x350
53 20 30 34	29x23x13x350

FLAT COLD CHISEL

- ▶ **DIN 7254**
- ▶ Drop forged chrome vanadium steel, heat treated
- ▶ Hardened head to HRC54—58
- ▶ Painting finish for increased visibility
- ▶ Used for shaping, cutting, and chipping

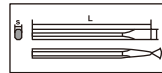

Item no.	axs x L (mm)
53 20 30 42	12x10x130
53 20 30 43	15x12x150
53 20 30 44	20x12x250
53 20 30 45	18x14x175
53 20 30 46	23x16x250
53 20 30 47	22(23)x16x300
53 20 30 48	22x16x350
53 20 30 49	24x16x400
53 20 30 50	26(30)x18x300
53 20 30 51	26(30)x18x350
53 20 30 52	26(30)x18x400
53 20 30 53	22x20x250
53 20 30 54	30x20x300
53 20 30 55	30x20x350
53 20 30 56	30x20x400
53 20 30 57	25x22x300
53 20 30 58	25x22x500
53 20 30 59	10x8x200
53 20 30 60	10x8x250
53 20 30 61	10x10x200
53 20 30 62	12x10x250
53 20 30 63	14x12x250
53 20 30 64	15x12x300
53 20 30 65	15x8x80
53 20 30 66	15x8x100
53 20 30 67	15x8x200
53 20 30 68	15x8x250

CROSS-CUT CHISEL

- ▶ Drop forged chrome vanadium steel, heat treated
- ▶ Hardened head to HRC54—58
- ▶ Painting finish for increased visibility
- ▶ Used for shaping, cutting, and chipping

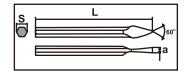

Item no.	axs x L (mm)
53 20 30 76	5x10x130
53 20 30 77	7x12x150
53 20 30 78	9x16x175
53 20 30 79	10x18x200

BRICK CHISEL

- ▶ Drop forged chrome vanadium steel, heat treated
- ▶ Hardened head to HRC54—58
- ▶ Painting finish for increased visibility
- ▶ Used for shaping, cutting, and chipping

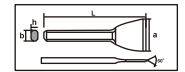

Item no.	axb x hxL (mm)
53 20 30 80	50x23x13x240
53 20 30 81	60x23x13x240
53 20 30 82	70x23x13x240
53 20 30 83	70x23x13x220
53 20 30 84	55x23x13x250
53 20 30 85	60x18x230
53 20 30 86	60x18x260

CROSS-CUT CHISEL

- ▶ **DIN 6451**
- ▶ Drop forged chrome vanadium steel, heat treated
- ▶ Hardened head to HRC54—58
- ▶ Painting finish for increased visibility
- ▶ Used for shaping, cutting, and chipping

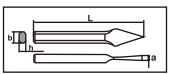

Item no.	axb x hxL (mm)
53 20 30 35	5x14x9x125
53 20 30 36	6x17x11x150
53 20 30 37	7x17x11x175
53 20 30 38	6x17x11x200
53 20 30 39	8x20x12x220
53 20 30 40	9x23x13x250
53 20 30 41	10x23x13x300

BRICK CHISEL

- ▶ Drop forged chrome vanadium steel, heat treated
- ▶ Hardened head to HRC54—58
- ▶ Painting finish for increased visibility
- ▶ Used for shaping, cutting, and chipping

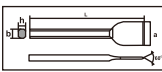

Item no.	axb x hxL (mm)
53 20 30 69	50x20x12x250
53 20 30 70	60x20x12x230
53 20 30 71	50x23x13x250
53 20 30 72	75x23x13x230
53 20 30 73	60x26x13x250
53 20 30 74	70x26x13x250
53 20 30 75	80x26x13x300

CENTER PUNCH

- ▶ **DIN 7250**
- ▶ Drop forged chrome vanadium steel, heat treated
- ▶ Hardened head to HRC54—58
- ▶ Painting finish for increased visibility
- ▶ Used for shaping, cutting, and chipping

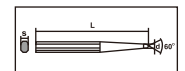

Item no.	dxs x L (mm)
53 20 30 87	3x8x120
53 20 30 88	4x10x120
53 20 30 89	3x10x150
53 20 30 90	5x12x120
53 20 30 91	5x12x150

DRIFT PUNCH

- ▶ **DIN 6458**
- ▶ Drop forged chrome vanadium steel, heat treated
- ▶ Hardened head to HRC54—58
- ▶ Painting finish for increased visibility
- ▶ Used for shaping, cutting, and chipping

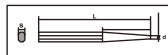

Item no.	axsxL(mm)
53 20 31 01	1x10x120
53 20 31 02	2x10x120
53 20 31 03	3x10x120
53 20 31 04	4x10x120
53 20 31 05	5x10x120
53 20 31 06	6x10x120
53 20 31 07	8x10x120
53 20 31 08	3x10x150
53 20 31 09	5x10x150
53 20 31 10	8x12x150

NAIL PUNCH

- ▶ Drop forged chrome vanadium steel, heat treated
- ▶ Hardened head to HRC54—58
- ▶ Painting finish for increased visibility
- ▶ Used for shaping, cutting, and chipping

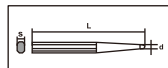

Item no.	dxsxL(mm)
53 20 31 25	2x10x120
53 20 31 26	3x10x120
53 20 31 27	4x10x120
53 20 31 28	5x10x120
53 20 31 29	6x10x120

POINTED CHISEL WITH HANDLE

- ▶ Drop forged chrome vanadium steel, heat treated
- ▶ Hardened head to HRC54—58
- ▶ Painting finish for increased visibility
- ▶ Used for shaping, cutting, and chipping



Item no.	axsxL(mm)	axsxL(mm")
53 20 31 30	4x16x254	5/32x5/8x10
	4x16x305	5/32x5/8x12
	4x19x254	5/32x3/4x10
	4x19x305	5/32x3/4x12
	4x19x355	5/32x3/4x14

COLD CHISEL WITH HANDLE

- ▶ Drop forged chrome vanadium steel, heat treated
- ▶ Hardened head to HRC54—58
- ▶ Painting finish for increased visibility
- ▶ Used for shaping, cutting, and chipping



Item no.	axsxL(mm)	axsxL(mm")
53 20 31 31	19x16x254	3/4x5/8x10
	19x16x305	3/4x5/8x12
	25x19x254	1x3/4x10
	25x19x305	1x3/4x12
	25x19x355	1x3/4x14

3PCS NAIL SET

- ▶ Chrome vanadium steel, hardened and tempered, black finished
- ▶ With plastic protection



Item no.	Pointsize	Shanksize	Length
53 10 90 01	35	5/16" (8mm)	5" (125mm)
	1/16" (1.5mm)	5/16" (8mm)	5" (125mm)
	3/32" (2.5mm)	5/16" (8mm)	5" (125mm)

3PCS PUNCH AND CHISEL SET

- ▶ Chrome vanadium steel, hardened and tempered, black finished
- ▶ With plastic protection



Item no.	Pointsize	Shanksize	Length
53 10 90 02	Cold chisel 3/8" (10mm)	5/16" (8mm)	5" (125mm)
	Pin punch 1/8" (3mm)	5/16" (8mm)	5" (125mm)
	Center punch 1/8" (3mm)	5/16" (8mm)	5" (125mm)

3PCS PUNCH AND CHISEL SET

- ▶ Chrome vanadium steel, hardened and tempered, black finished
- ▶ With plastic protection



Item no.	Pointsize	Shanksize	Length
53 10 90 03	Cold chisel 3/8" (10mm)	5/16" (8mm)	5" (125mm)
	Pin punch	1/8" (3mm) 5/16" (8mm)	5" (125mm)
	Solid punch	1/8" (3mm) 5/16" (8mm)	5" (125mm)

3PCS COLD CHISEL SET

- ▶ Chrome vanadium steel, hardened and tempered
- ▶ Powder coated or black finished

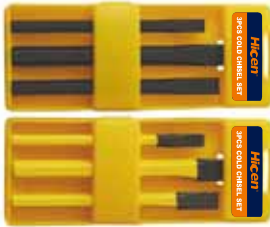

Item no.	Pointsize	Shanksize	Length
53 10 90 04	3/8" (10mm)	5/16" (8mm)	5-9/16" (142mm)
	1/2" (13mm)	3/8" (10mm)	6" (152mm)
	5/8" (16mm)	1/2" (13mm)	6-3/4" (170mm)

6PCS PUNCH AND CHISEL SET

- ▶ Chrome vanadium steel, hardened and tempered
- ▶ Powder coated or black finished

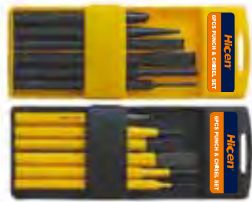

Item no.	Pointsize	Shanksize	Length
53 10 90 05	Solid punch 3/32" (2mm)	3/8" (10mm)	5-1/2" (140mm)
	Cold chisel 3/8" (10mm)	5/16" (8mm)	5-9/16" (142mm)
	Cold chisel 1/2" (12mm)	3/8" (10mm)	6" (152mm)
	90° Center punch 1/4" (6mm)	3/8" (10mm)	4" (100mm)
	Solid punch 1/8" (3mm)	5/16" (8mm)	6" (152mm)
	Solid punch 1/4" (6mm)	3/8" (10mm)	6" (152mm)

6PCS COLD CHISEL SET

- ▶ Chrome vanadium steel, hardened and tempered
- ▶ Powder coated or black finished

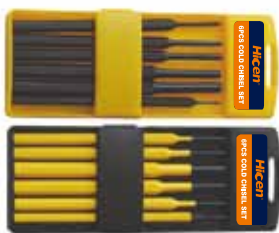

Item no.	Pointsize	Shanksize	Length
53 10 90 06	1/16" (1.5mm)	1/4" (6mm)	6" (152mm)
	1/8" (3mm)	5/16" (8mm)	6" (152mm)
	5/32" (4mm)	1/4" (6mm)	6" (152mm)
	3/16" (5mm)	5/16" (8mm)	6" (152mm)
	1/4" (13mm)	3/8" (10mm)	6" (152mm)
	5/16" (8mm)	3/8" (10mm)	6" (152mm)

12PCS PUNCH AND CHISEL SET

- ▶ Chrome vanadium steel, hardened and tempered
- ▶ Powder coated or black finished



Item no.	Pointsize	Shanksize	Length
53 10 90 07	90° Center punch 1/4" (6mm)	3/8" (10mm)	4" (100mm)
	90° Center punch 5/16" (6.8mm)	3/8" (10mm)	4-1/2" (115mm)
	Solid punch 3/32" (2mm)	3/8" (10mm)	5-1/2" (140mm)
	Pin punch 1/16" (1.5mm)	5/16" (8mm)	6" (152mm)
	Pin punch 1/8" (3mm)	5/16" (8mm)	6" (152mm)
	Pin punch 5/32" (4mm)	3/8" (10mm)	6" (152mm)
	Pin punch 3/16" (5mm)	3/8" (10mm)	6" (152mm)
	Pin punch 1/4" (6mm)	7/16" (12mm)	6" (152mm)
	Pin punch 5/16" (8mm)	7/16" (12mm)	6" (152mm)
	Cold chisel 3/8" (10mm)	5/16" (8mm)	5-9/16" (140mm)
	Cold chisel 1/2" (12mm)	3/8" (10mm)	6" (152mm)
	Cold chisel 5/8" (16mm)	1/2" (12mm)	6-3/4" (170mm)

6PCS COLD CHISEL SET

- ▶ Chrome vanadium steel, hardened and tempered
- ▶ Powder coated or black finished



Item no.	Contents
53 10 90 22	1pcs cold chisel: 13x10x152mm (1/2"x3/8"x6")
	1pcs cape chisel: 5x8x152mm (3/16"x5/16"x6")
	1pcs solid chisel: 2x10x140mm (3/32"x3/8"x5-1/2")
	1pcs pin chisel: 6x10x152mm (1/4"x3/8"x6")
	1pcs pin chisel: 8x10x152mm (5/16"x3/8"x6")

6PCS PUNCH AND CHISEL SET

- ▶ Chrome vanadium steel
- ▶ The tips are accurately ground, with specially tempered head
- ▶ Golden lacquering
- ▶ Packed in steel metal case



Item no.	Contents
53 10 90 08	1pc. Cold chisel 12x130x10mm
	1pc. Cold chisel 15x150x12mm
	1pc. Taper punch 3x120x10mm
	1pc. Taper punch 4x150x12mm
	1pc. Pin punch 4x120x10mm
	1pc. Cape chisel 4x130x10mm

6PCS PUNCH AND CHISEL SET

- ▶ Made of high quality chrome vanadium steel for long life. The tips are accurately ground, with specially tempered head. Golden lacquering. Packed in steel metal case



Item no.	Contents
53 10 90 09	1pc. Pin punch 3x150x10mm
	1pc. Pin punch 5x150x10mm
	1pc. Pin punch 8x150x12mm
	1pc. Taper punch 3x150x10mm
	1pc. Taper punch 5x150x10mm
	1pc. Taper punch 8x150x12mm

6PCS PIN PUNCH SET

- ▶ Made of high quality chrome vanadium steel for long life. The tips are accurately ground, with specially tempered head. Golden lacquering. Packed in steel metal case



Item no.	Contents
53 10 90 10	2, 3, 4, 5, 6, 8mm

12PCS PUNCH AND CHISEL SET

- ▶ Carbon steel, hardened and tempered.
- ▶ With special shot blasted finished
- ▶ Packed in strong plastic bag.

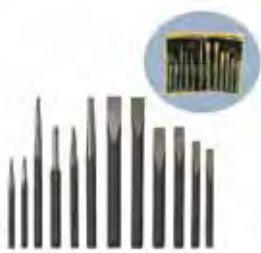

Item no.	Contents
53 10 90 11	6 pcs. cold chisels: 1/2" x6-1/2", 5/8" x7", 3/4" x8", 7/8" x10", 1" x10"; 3 pcs. Taper punch: 1/8" x6", 7/32" x10", 3/8" x10" 1 pc. Pin punch: 3/8" x8"

6PCS PUNCH AND CHISEL SET

- ▶ Chrome vanadium steel, hardened and tempered
- ▶ Powder coated or black finished



Item no.	Pointsize	Shanksize	Length
53 10 90 12	Cold chisel 5/8" (16mm)	1/2" (13mm)	3/8" (10mm)
	Cold chisel 3/4" (19mm)	1/2" (12mm)	7" (178mm)
	Cold chisel 1" (25mm)	3/8" (10mm)	7" (178mm)
	Pin punch 1/8" (3mm)	5/16" (8mm)	7" (178mm)
	Center punch 1/8" (3mm)	5/16" (8mm)	7" (178mm)
	Solid punch 5/32" (4mm)	3/8" (10mm)	7" (178mm)

6PCS COLD CHISEL SET

- ▶ Chrome vanadium steel, hardened and tempered
- ▶ Powder coated or black finished



Item no.	Pointsize	Shanksize	Length
53 10 90 13	1/16" (1.5mm)	5/16" (8mm)	7" (178mm)
	1/8" (3mm)	5/16" (8mm)	7" (178mm)
	5/32" (4mm)	3/8" (10mm)	7" (178mm)
	3/16" (5mm)	3/8" (10mm)	7" (178mm)
	1/4" (13mm)	7/16" (12mm)	7" (178mm)
	5/16" (8mm)	7/16" (12mm)	7" (178mm)

3PCS NAIL PUNCH SET

- ▶ Carbon steel, hardened and tempered
- ▶ With special shot blasted finished



Item no.	Contents
53 10 90 14	1/32", 3/32", 3/32"

2PCS COLD CHISEL SET

- ▶ Carbon steel, hardened and tempered
- ▶ With special shot blasted finished



Item no.	Contents
53 10 90 15	26X7X240 70X23X13X240mm

5PCS PUNCH AND CHISEL SET



Item no.	Contents
53 10 90 16	1pc cold chisel 7/16"X3/8"X5" 1pc cape chisel: 5/32"X3/8"X5" 1pc pin punch: 5/32"X3/8"X6" 1pc center punch 5/32"X3/8"X4-3/4" 1pc taper punch: 1/8"X3/8"X4-3/4"

6PCS PUNCH SET



Item no.	Contents
53 10 90 17	3pcs pin punch 3X10X150,5X10X150, 8X12x150mm 3pcs taper punch

6PCS PUNCH AND CHISEL SET

- ▶ 2pcs cold chisel: 15X12X150 11X10X130mm
- ▶ 1 pc center punch: 3X10X120mm
- ▶ 2 pcs taper punch: 3X10X120 4x12X150mm
- ▶ 1pc cape chisel: 4X10X130mm



Item no.	Contents
53 10 90 18	2pcs cold chisel: 15X12X150 11X10X130mm 1 pc center punch: 3X10X120mm 2 pcs taper punch: 3X10X120 4x12X150mm 1pc cape chisel: 4X10X130mm

9PCS LEATHER PUNCHER

- ▶ Matrail: C45, Hardened



Item no.	Contents
53 10 90 19	2.5/3/4/5/6/7/8/9/10mm

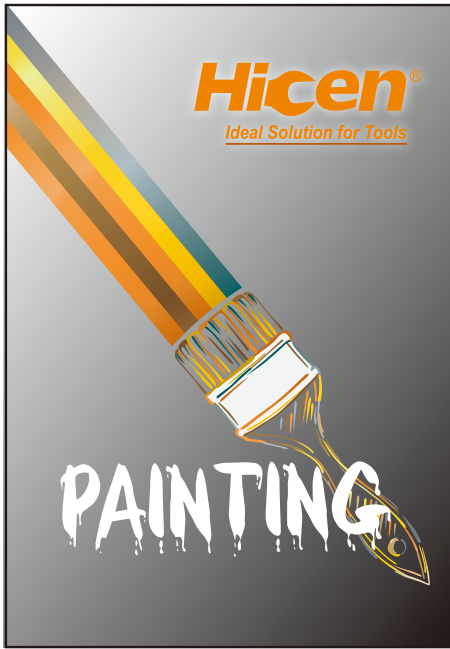

BUILDING, WOODWORKING
PAINTING TOOLS

9PCS NUMBER PUNCHER

- ▶ 9 pcs puncher, incl. number 0-9
- ▶ 6mm
- ▶ In plastic box



Item no.	Contents
53 10 90 20	

27PCS LETTER PUNCHER

- ▶ 27 pcs puncher, Incl. letter A-Z and &
- ▶ Black finish
- ▶ DIN1451
- ▶ In plastic box



Item no.	Contents
53 10 90 21	

PAINT BRUSH

- ▶ Flat paint brushes
- ▶ White bristle in chrome plated ferrule
- ▶ Plastic handle in classic style



Item no.	Contents
55 20 00 01	1"
55 20 00 02	1.5"
55 20 00 03	2"
55 20 00 04	2.5"
55 20 00 05	3"
55 20 00 06	4"

PAINT BRUSH

- ▶ Flat paint brushes
- ▶ White bristle in chrome plated ferrule
- ▶ Lacquered beaver tail plastic handle with trumpet hanging hole



Item no.	Contents
55 20 20 01	1"
55 20 20 02	1.5"
55 20 20 03	2"
55 20 20 04	2.5"
55 20 20 05	3"
55 20 20 06	4"

PAINT BRUSH

- ▶ Flat paint brushes
- ▶ White bristle in chrome plated ferrule
- ▶ Plastic handle with long hanging hole.



Item no.	Contents
55 20 20 07	1"
55 20 20 08	1.5"
55 20 20 09	2"
55 20 20 10	2.5"
55 20 20 11	3"
55 20 20 12	4"

PAINT BRUSH

- ▶ Flat paint brushes
- ▶ PVC bristle in chrome plated ferrule
- ▶ Plastic handle



Item no.	Contents
55 20 20 19	1"
55 20 20 20	1.5"
55 20 20 21	2"
55 20 20 22	2.5"
55 20 20 23	3"
55 20 20 24	4"

PAINT BRUSH

- ▶ Flat paint brushes
- ▶ PET & white bristle in chrome plated ferrule
- ▶ Wooden handle



Item no.	Contents
55 20 00 07	1"
55 20 00 08	1.5"
55 20 00 09	2"
55 20 00 10	2.5"
55 20 00 11	3"
55 20 00 12	4"

5PCS PAINT BRUSH SET

- ▶ Flat paint brushes
- ▶ White bristle in chrome plated ferrule
- ▶ In PVC hanging pouch



Item no.	Contents
55 90 00 06	1", 1.5", 2", 2.5", 3"

3PCS PAINT BRUSH SET

- ▶ Flat paint brushes
- ▶ White bristle in chrome plated ferrule
- ▶ Lacquered plastic handle
- ▶ In PVC hanging pouch



Item no.	Contents
55 90 00 07	20,30,40mm

5PCS PAINT BRUSH SET

- ▶ Flat paint brushes
- ▶ White bristle in chrome plated ferrule
- ▶ Wooden handle
- ▶ In half double blister card



Item no.	Contents
55 90 00 08	1", 1.5", 2", 2.5", 3"

5PCS PAINT BRUSH SET

- ▶ Flat paint brushes
- ▶ PET bristle in chrome plated ferrule
- ▶ Lacquered Wooden handle
- ▶ In half double blister card



Item no.	Contents
55 90 00 09	1", 1.5", 2", 2.5", 3"

3PCS PAINT BRUSH SET

- ▶ Flat paint brushes
- ▶ PET bristle in chrome plated ferrule
- ▶ Lacquered plastic handle
- ▶ In PVC hanging pouch



Item no.	Contents
55 90 00 10	1", 2", 3"

ROUND BRUSH SET

- ▶ White tie red plastic cap
- ▶ White bristle
- ▶ Natural well sanded wood handle.



Item no.	Contents
55 20 00 13	2#
55 20 00 14	4#
55 20 00 15	6#
55 20 00 16	8#
55 20 00 17	10#
55 20 00 18	12#
55 20 00 19	14#
55 20 00 20	16#
55 20 00 21	18#

PAINT BRUSH

- ▶ Advanced synthetic tapered filaments for professional finish
- ▶ Ergonomically design soft handle for comfort working



Item no.	Contents
55 20 10 01	1"
55 20 10 02	1.5"
55 20 10 03	2"
55 20 10 04	2.5"
55 20 10 05	3"
55 20 10 06	4"

PAINT BRUSH

- ▶ Advanced synthetic tapered filaments for professional finish
- ▶ Ergonomically design soft handle for comfort working



Item no.	Contents
55 20 10 07	1"
55 20 10 08	1.5"
55 20 10 09	2"
55 20 10 10	2.5"
55 20 10 11	3"
55 20 10 12	4"

ROUND BRUSH SET

- ▶ Black bristle in chrome plated ferrule
- ▶ Plastic handle



Item no.	Contents
55 20 20 25	2#
55 20 20 26	4#
55 20 20 27	6#
55 20 20 28	8#



ROUND BRUSH SET

- ▶ White bristle in brass plated ferrule
- ▶ Plastic handle



Item no.	Contents
55 20 20 29	2#
55 20 20 30	4#
55 20 20 31	6#
55 20 20 32	8#

PAINT BRUSH

- ▶ Flat paint brushes, curved head
- ▶ White bristle in chrome plated ferrule
- ▶ Plastic handle with hanging hole



Item no.	Contents
55 20 20 01	1"
55 20 20 02	1.5"
55 20 20 03	2"

PAINT BRUSH

- ▶ Flat paint brushes, curved head
- ▶ White bristle in chrome plated ferrule
- ▶ Plastic handle with hanging hole



Item no.	Contents
55 20 20 33	1"
55 20 20 34	1.5"
55 20 20 35	2"

4PCS PAINT BRUSH SET



Item no.	Contents
55 99 00 01	1", 2", 3", 4"



BUILDING, WOODWORKING
PAINTING TOOLS

PASTE AND WIRE BRUSH

- ▶ PP bristle
- ▶ Plastic handle

Item no.	Contents
53 99 00 01	170x75mm

3PCS WALL BRUSH SET

- ▶ PP/PET bristle
- ▶ Wooden handle/Plastic handle

Item no.	Contents
53 99 10 01	295mm;305mm;310mm

CEILING AND WALL BRUSH

- ▶ PP bristle
- ▶ Plastic handle

Item no.	Contents
53 99 10 05	170x70mm

PASTE AND WIRE BRUSH

- ▶ PP bristle
- ▶ Plastic / wooden handle

Item no.	Contents
53 99 00 04	190x70mm
53 99 00 05	185x70mm
53 99 00 06	165x50mm

3PCS WALL BRUSH SET

- ▶ PP bristle
- ▶ Plastic handle

Item no.	Contents
53 99 10 02	175mm;230mm;230mm

CEILING AND WALL BRUSH

- ▶ PP bristle
- ▶ Plastic handle

Item no.	Contents
53 99 10 06	170x75mm,9x21row

CEILING BRUSH

- ▶ Pure bristle
- ▶ Wooden handle
- ▶ Color box packing

Item no.	Contents
53 99 00 07	170x70mm

CEILING AND WALL BRUSH

- ▶ PP bristle
- ▶ Bi-color plastic handle

Item no.	Contents
53 99 10 03	130x40mm

CEILING AND WALL BRUSH

- ▶ Round type
- ▶ PP bristle
- ▶ Plastic handle

Item no.	Contents
53 99 10 07	Φ105mm

CEILING AND WALL BRUSH

- ▶ White bristle in chrome plated ferrule
- ▶ PP handle

Item no.	Contents
53 99 00 08	30x70mm
53 99 00 09	30x100mm
53 99 00 10	30x120mm
53 99 00 11	40x140mm
53 99 00 12	50x150mm

CEILING AND WALL BRUSH

- ▶ PP bristle
- ▶ Plastic handle

Item no.	Contents
53 99 10 04	130x40mm

BROOM

- ▶ PP bristle
- ▶ Wooden handle

Item no.	Contents
53 99 10 08	300mm
53 99 10 09	400mm
53 99 10 10	500mm
53 99 10 11	600mm
53 99 10 12	800mm

BROOM

- ▶ PP bristle
- ▶ Plastic handle



Item no.	Contents
53 99 10 13	14", 18", 24"

BROOM

- ▶ PP bristle
- ▶ Plastic handle



Item no.	Contents
53 99 10 14	170x60mm

BROOM

- ▶ PP bristle
- ▶ Plastic handle



Item no.	Contents
53 99 10 15	280x60mm

21PCS PAINT BRUSH SET

- ▶ In ploy bag and head card



Item no.	Contents
53 99 00 15	

PAINT ROLLER

- ▶ Acrylic material
- ▶ Water resistant glue



Item no.	Contents
55 30 40 01	7"
55 30 40 02	9"
55 30 40 03	10"

PAINT ROLLER

- ▶ Acrylic material
- ▶ Hot melt glue

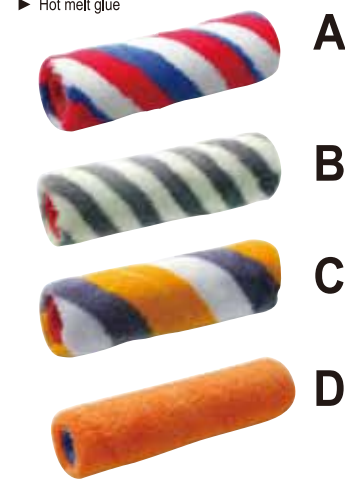

Item no.	Contents
55 30 40 04	7"
55 30 40 05	9"
55 30 40 06	10"

PAINT ROLLER

- ▶ Acrylic material
- ▶ Solvent resistant glue



Item no.	Contents
55 30 40 07	7"
55 30 40 08	9"
55 30 40 09	10"

PAINT ROLLER

- ▶ Nylon material
- ▶ Hot melt glue



Item no.	Contents
55 30 40 10	7"
55 30 40 11	9"
55 30 40 12	10"



PAINT ROLLER

- ▶ Polyamide material
- ▶ Water resistant glue



Item no.	Contents
55 30 40 13	7"
55 30 40 14	9"
55 30 40 15	10"

PAINT ROLLER

- ▶ Polyester material
- ▶ Hot melt glue



Item no.	Contents
55 30 40 16	7"
55 30 40 17	9"
55 30 40 18	10"

PAINT ROLLER

- ▶ Microfiber material
- ▶ Solvent resistant glue



Item no.	Contents
55 30 40 19	7"
55 30 40 20	9"
55 30 40 21	10"

PAINT ROLLER

- ▶ White velour fabric



Item no.	Contents
55 30 40 22	2"
55 30 40 23	4"

PAINT ROLLER

- ▶ Sponge roller



Item no.	Contents
55 30 40 24	6"
55 30 40 25	7"
55 30 40 26	9"

PAINT ROLLER

- ▶ Polyacrylic fabric/chemical fabric / micro fabric



Item no.	Contents
55 30 40 27	4"

PAINT ROLLER

- ▶ Polyacrylic fabric



Item no.	Contents
55 30 40 28	7"
55 30 40 29	9"

PAINT ROLLER

- ▶ White velour fabric



Item no.	Contents
55 30 40 30	4"
55 30 40 31	7"
55 30 40 32	9"

PAINT ROLLER

- ▶ Yellow color chemical fabric



Item no.	Contents
55 30 40 33	6"
55 30 40 34	7"
55 30 40 35	9"

PAINT ROLLER

- ▶ Polyacrylic fabric



Item no.	Contents
55 30 40 36	6"
55 30 40 37	7"
55 30 40 38	9"

WALLPAPER ROLLER



Item no.	Contents
53 30 40 40	

MINI PAINT ROLLER



Item no.	Contents
53 30 40 41	

MINI PLASTIC WATERPAPER ROLLER



Item no.	Contents
53 30 40 42	

MINI WALLPAPER ROLLER



Item no.	Contents
53 30 40 43	

PAINT ROLLER FRAME

- ▶ Steel wire with chrome plated
- ▶ TPR 2 colors handle



Item no.	Contents
55 30 60 39	7"
55 30 60 40	9"

PAINT ROLLER FRAME

- ▶ Steel wire with chrome plated
- ▶ Plastic handle



Item no.	Contents
55 30 60 41	7"
55 30 60 42	9"

PAINT ROLLER FRAME

- ▶ Steel wire with chrome plated
- ▶ Plastic handle



Item no.	Contents
55 30 60 43	7"
55 30 60 44	9"

RUBBER PAINT ROLLER

- ▶ Rubber roller
- ▶ Steel wire with chrome plated
- ▶ Plastic handle



Item no.	Contents
55 30 00 45	7"
55 30 00 46	9"

PAINT ROLLER SET

- ▶ Plastic handle with fender controlled by light switches
- ▶ With 3 extra roller and plastic tray
- ▶ Suitable for walls, stucco, bricks & numerous other surface; Great for narrow spaces & corners
- ▶ Can easily paint hard to reach places



Item no.	Contents
55 90 00 16	

PAINT ROLLER SET

- ▶ With plastic tray packing



Item no.	Contents
55 90 00 17	10pcs 4" rollers 1pc 4" roller frame

PAINT ROLLER SET

- ▶ Plastic shrinking packing



Item no.	Contents
55 90 00 18	1pc plastic paint tray 2pcs 4" rollers 1pc 4" roller frame

PAINT ROLLER SET



Item no.	Contents
55 90 00 20	1pc plastic paint tray 2pcs sponge rollers 1pc roller frame

PAINT ROLLER SET

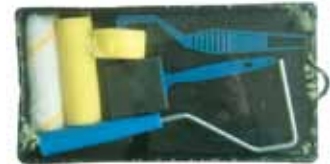

Item no.	Contents
55 90 00 21	1pc plastic paint tray 1pc roller frame 1pc 50mm sponge roller 1pc polyacrylic roller 1pc plastic holder 1pc 2" sponge roller

**PAINT ROLLER
SPECIFICATION GUIDE**

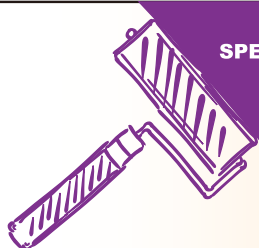

Short Pile (5 to 9mm): Ideal for smooth surfaces- walls, ceilings, metal doors and drywall.
Medium Pile(10 to 18mm): Ideal for smooth and semi-rough surfaces- drywall and rough wood.
High Pile(19 to 32mm): Ideal for rough and textured surfaces- brick, fences and textured ceilings.



PAINT ROLLER SET



Item no.	Contents
55 90 00 22	1pc plastic paint tray 1pc roller frame 2pcs rollers 1pc 1.5" paint brush 1pc sponge roller 1pc paint mesh

PAINT ROLLER SET



Item no.	Contents
55 90 00 23	1pc 10" plastic paint tray 1pc 9" roller 1pc 4x5 plastic sheet 1pc 2x25mm wall paper 1pc plastic holder 1pc knife 1pc 3x10 ceiling brush 1pc 1.5" paint brush 1pc sanding paper

PAINT ROLLER SET



Item no.	Contents
55 90 00 24	1pc 7" paint tray 1pc 7" paint roller 1pc 7" paint holder 1pc 7" paint mesh 2pc sponge rollers 1pc 4" polyacrylic fabric roller 1pc #4 round paint brush 1pc 2" plastic holder 1pc 2" sponge roller 1pc 4x10 holder 1pc 1.5" paint brush

10PCS PAINTING KIT



Item no.	Contents
55 90 00 30	7"

7PCS PAINTING KIT



Item no.	Contents
55 90 00 31	7"

8PCS PAINTING KIT



Item no.	Contents
55 90 00 32	7"

5PCS PAINTING KIT



Item no.	Contents
55 90 00 33	7"

8PCS PAINTING KIT



Item no.	Contents
55 90 00 34	7"

7PCS PAINTING KIT



Item no.	Contents
55 90 00 35	4"

5PCS PAINTING KIT



Item no.	Contents
55 90 00 36	4"

8PCS PAINTING KIT



Item no.	Contents
55 90 00 37	4"

6PCS PAINTING KIT



Item no.	Contents
55 90 00 38	4"

6PCS PAINTING KIT



Item no.	Contents
55 90 00 39	4"

6PCS PAINTING KIT



Item no.	Contents
55 90 00 40	4"

PAINT TRAY

- ▶ Plastic material



Item no.	Contents
55 40 40 01	

PAINT MESH

- ▶ Plastic material



Item no.	Contents
55 40 60 01	

PAINT MIXER

- ▶ Carbon steel shank with Zinc plated
- ▶ Carbon steel mixer head with powder coating
- ▶ Rubber hanging hole



Item no.	Contents
55 40 20 01	60x350mm

PAINT MIXER

- ▶ Carbon steel shank with powder coating
- ▶ Carbon steel mixer head with powder coating
- ▶ Rubber hanging hole



Item no.	Contents
55 40 20 02	60X400mm
55 40 20 03	80X400mm
55 40 20 04	100X600MM
55 40 20 05	120X600mm
55 40 20 06	140X600mm

PAINT MIXER

- ▶ Carbon steel shank with Zinc plated
- ▶ Carbon steel mixer head with Zinc plated
- ▶ Rubber hanging hole



Item no.	Contents
55 40 20 07	70X400mm
55 40 20 08	90X500mm
55 40 20 09	110X500mm

PAINT MIXER

- ▶ Carbon steel shank with Zinc plated
- ▶ Carbon steel mixer head with Zinc plated
- ▶ Rubber hanging hole



Item no.	Contents
55 40 20 10	90X450mm
55 40 20 11	100X450mm
55 40 20 12	120X450mm

PAINT MIXER

- ▶ Carbon steel shank with Zinc plated
- ▶ Carbon steel mixer head with Zinc plated
- ▶ Rubber hanging hole



Item no.	Contents
55 40 20 13	140X600mm
55 40 20 14	160X600mm

PAINT GUSH ROLLER

- ▶ Stronge plastic mold body
- ▶ Plastic ball knob for simple handling
- ▶ Advanced scale adjustor for texture control
- ▶ Replaceable honeycomb flicker roller



Item no.	Contents
55 99 00 09	

PAINT GUSH ROLLER

- ▶ Heavy duty
- ▶ Zinc plate body with plastic handle
- ▶ Plastic ball knob for simple handling
- ▶ Advanced scale adjustor for texture control



Item no.	Contents
55 99 00 10	



PAINT GUSH ROLLER

- ▶ Stainless body with plastic handle
- ▶ Large grip for easy hand rotary action
- ▶ Adjustable tension bar for texture control
- ▶ Replaceable flicker roller



Item no.	Contents
55 99 00 11	

EXTENTION ROD

- ▶ Material: Steel / Aluminum
- ▶ Connection: Thread/ Adaptor
- ▶ Locking system: Inner / Outter lock



Item no.	Contents
55 99 00 15	

ROLLER SCRAPER, WOODEN HANDLE



Item no.	Contents
55 99 00 16	

ROLLER SCRAPER, ALUMINIUM HANDLE



Item no.	Contents
55 99 00 17	

CONSTRUCTION DIPPER



Item no.	Contents
55 99 00 18	

CONSTRUCTION DIPPER



Item no.	Contents
55 99 00 19	

RUBBER PUTTY BOWL



Item no.	Contents
55 99 00 20	

RUBBER PUTTY BOWL



Item no.	Contents
55 99 00 21	

PLASTIC WALL PAPER SCRAPER



Item no.	Contents
55 99 00 22	

PLASTIC WALL PAPER SCRAPER



Item no.	Contents
55 99 00 23	

METAL BUCKET GRID

- ▶ 2 gallon



Item no.	Contents
55 99 00 24	

WALL PAPER TRIM GUIDE



Item no.	Contents
55 99 00 25	

WALL PAPER TRIM GUIDE



Item no.	Contents
55 99 00 26	450mm

PAINT BUCKET OPENNER



Item no.	Contents
55 99 00 27	

MUD PAN



Item no.	Contents
55 99 00 28	12"

PLASTIC PUTTY KNIFE

- ▶ With teeth



Item no.	Contents
55 99 00 29	8"
55 99 00 30	1.5",2",3",4",6",8",10"

SQUAARE SCRAPER

- ▶ Stainless steel blade
- ▶ Plywood handle



Item no.	Contents
55 99 00 31	100mm
55 99 00 32	150mm
55 99 00 33	200mm
55 99 00 34	250mm
55 99 00 35	300mm
55 99 00 36	350mm
55 99 00 37	400mm
55 99 00 38	450mm
55 99 00 39	500mm
55 99 00 40	600mm

WALL SCRAPER

- ▶ Polished steel
- ▶ Wooden handle 1/3 red lacquered with hang hole



Item no.	Contents
55 10 00 01	30mm
55 10 00 02	40mm
55 10 00 03	50mm
55 10 00 04	60mm
55 10 00 05	80mm
55 10 00 06	100mm

3PCS PAINTER'S SCRAER SET

- ▶ Polished steel
- ▶ Wooden handle with hang hole
- ▶ In polybag



Item no.	Contents
55 90 00 25	30-50-80mm

STAINLESS WALL SCRAPER

- ▶ Stainless steel blades
- ▶ With plastic handle and hole.



Item no.	Contents
55 10 20 08	30mm
55 10 20 09	40mm
55 10 20 10	50mm
55 10 20 11	60mm
55 10 20 12	80mm
55 10 20 13	100mm
55 10 20 14	120mm

WALL SCRAPER

- ▶ Mirror polished steel blades
- ▶ With wooden handle and hole.



Item no.	Contents
55 10 20 15	30mm
55 10 20 16	40mm
55 10 20 17	50mm
55 10 20 18	60mm
55 10 20 19	80mm
55 10 20 20	100mm
55 10 20 21	120mm

PUTTY KNIFE

- ▶ 420# stainless steel blade,mirror polished
- ▶ Plastic handle



Item no.	Contents
55 10 00 22	1"
55 10 00 23	1.5"
55 10 00 24	2"
55 10 00 25	2.5"
55 10 00 26	3"
55 10 00 27	4"
55 10 00 28	5"
55 10 00 29	6"

PUTTY KNIFE

- ▶ 420# stainless steel blade with teeth, mirror polished
- ▶ Wooden handle, lacquered on the end



Item no.	Contents
55 10 00 30	1"
55 10 00 31	1.5"
55 10 00 32	2"
55 10 00 33	2.5"
55 10 00 34	3"
55 10 00 35	4"
55 10 00 36	5"
55 10 00 37	6"

PUTTY KNIFE

- ▶ 420# stainless steel blade, mirror polished
- ▶ Wooden handle



Item no.	Contents
55 10 00 54	1"
55 10 00 55	1.5"
55 10 00 56	2"
55 10 00 57	2.5"
55 10 00 58	3"
55 10 00 59	4"

WALL SCRAPER

- ▶ Mirror polished steel blades
- ▶ With 2 color TPR handle and hole.



Item no.	Contents
55 10 20 27	38mm
55 10 20 28	50mm
55 10 20 29	75mm
55 10 20 30	100mm
55 10 20 31	125mm

PUTTY KNIFE

- ▶ 420# stainless steel blade, mirror polished
- ▶ Wooden handle, bi-colour lacquered on the end



Item no.	Contents
55 10 00 38	1"
55 10 00 39	1.5"
55 10 00 40	2"
55 10 00 41	2.5"
55 10 00 42	3"
55 10 00 43	4"
55 10 00 44	5"
55 10 00 45	6"

PUTTY KNIFE

- ▶ 420# stainless steel blade, mirror polished
- ▶ Wooden handle



Item no.	Contents
55 10 00 60	1"
55 10 00 61	1.5"
55 10 00 62	2"
55 10 00 63	2.5"
55 10 00 64	3"
55 10 00 65	4"

PUTTY KNIFE

- ▶ 420# stainless steel blade, mirror polished
- ▶ Bi-colour plastic handle



Item no.	Contents
55 10 20 32	1"
55 10 20 33	1.5"
55 10 20 34	2"
55 10 20 35	2.5"
55 10 20 36	3"
55 10 20 37	4"
55 10 20 38	5"
55 10 20 39	6"

PUTTY KNIFE

- ▶ 420# stainless steel blade, mirror polished
- ▶ Plastic handle



Item no.	Contents
55 10 00 46	1"
55 10 00 47	1.5"
55 10 00 48	2"
55 10 00 49	2.5"
55 10 00 50	3"
55 10 00 51	4"
55 10 00 52	5"
55 10 00 53	6"

WALL SCRAPER

- ▶ Mirror polished steel blades
- ▶ With 2 color TPR handle and hole.



Item no.	Contents
55 10 20 22	38mm
55 10 20 23	50mm
55 10 20 24	75mm
55 10 20 25	100mm
55 10 20 26	125mm

6 IN 1 PAINT TOOL

- ▶ Stainless steel blades
- ▶ With plastic handle and hole.



Item no.	Contents
55 10 40 01	63mm

6 IN 1 PAINT TOOL

- ▶ Steel blade
- ▶ With wooden handle



Item no.	Contents
55 10 40 02	

SQUARE SCRAPER

- ▶ 420# stainless steel blade, mirror polished
- ▶ Plastic handle



Item no.	Contents
55 10 40 03	140mm
55 10 40 04	160mm
55 10 40 05	180mm
55 10 40 06	200mm
55 10 40 07	240mm

SCRAPER

- ▶ 420# stainless steel blade, mirror polished
- ▶ Bi-color plastic handle



Item no.	Contents
55 10 40 08	140mm
55 10 40 09	160mm
55 10 40 10	180mm
55 10 40 11	200mm
55 10 40 12	240mm

TRIANGLE SCRAPER

- ▶ Well sharpened from all sides
- ▶ With wooden handle



Item no.	Contents
53 30 20 63	50mm

TRIANGLE SCRAPER

- ▶ Well sharpened from all sides
- ▶ With wooden handle



Item no.	Contents
53 30 30 13	50mm

TRIANGLE SCRAPER

- ▶ Well sharpened from all sides
- ▶ With wooden handle



Item no.	Contents
53 30 30 14	50mm

PLASTIC PUTTY KNIFE

- ▶ Material is ABS



Item no.	Contents
55 90 00 30	2"
	3"
	4"

PAINT MIXER

- ▶ Material is PP



Item no.	Contents
55 90 00 31	

4PCS WALL SCRAPER SET

- ▶ Material is PU



Item no.	Contents
55 90 00 27	50mm
	80mm
	100mm
	120mm

4PCS WALL SCRAPER SET

- ▶ Hardened steel blades with plastic end



Item no.	Contents
55 90 00 28	50mm
	80mm
	100mm
	120mm

PU SANDER

- ▶ Material:PU+sand paper



Item no.	Contents
55 90 00 34	

PLASTIC SLOT

- ▶ Material:PP



Item no.	Contents
55 90 00 37	345x120mm

KNEE PADS

- ▶ Material is PU



Item no.	Contents
55 90 00 32	

PU SANDER

- ▶ Material:PU+sand paper



Item no.	Contents
55 90 00 35	

REEL HOOK

- ▶ With roller
- ▶ Steel shaft,chrome plated
- ▶ Wooden handle



Item no.	Contents
55 90 00 38	

KNEE PADS

- ▶ Material is PU



Item no.	Contents
55 90 00 33	

PU SANDER

- ▶ Material:PU+sand paper



Item no.	Contents
55 90 00 36	

REEL HOOK

- ▶ Steel shaft with plastic handle



Item no.	Contents
55 90 00 39	300mm

SPONGE SANDING BLOCK



Item no.	Contents
35 80 00 01	

SANDING BLOCK

- ▶ Plastic material



Item no.	Contents
35 80 00 05	230x120mm

SANDING BLOCK

- ▶ BS material



Item no.	Contents
35 80 00 02	160x85mm
35 80 00 03	210x105mm

SANDER

- ▶ Aluminum alloy body with EVA
- ▶ Thickness of EVA:5mm



Item no.	Contents
35 80 00 06	233x83mm

SANDING BLOCK

- ▶ Steel shaft with plastic handle



Item no.	Contents
35 80 00 04	235x80mm



SAFETY AND PROTECTION

SAFETY HELMET

- ▶ ABS plastic Body
- ▶ Air holes at the top can be removed in the production
- ▶ GS approved



Item no.	Contents
58 10 00 01	

SAFETY HELMET

- ▶ ABS plastic Body
- ▶ Four-point double layer lining splicing structure
- ▶ X-type back ribbon lock
- ▶ CE approved
- ▶ ANSI approved



Item no.	Contents
58 10 00 02	

SAFETY HELMET

- ▶ PP plastic Body
- ▶ Six-point lining splicing structure
- ▶ Back ribbon lock



Item no.	Contents
58 10 00 03	

LEISURE CAP

- ▶ Cotton material



Item no.	Contents
58 10 00 04	58cm

SAFETY HELMET

- ▶ Cotton material



CE

Item no.	Contents
58 10 00 10	

SAFETY HELMET



CE

Item no.	Contents
58 10 00 11	

WELDING MASK

- ▶ Impact-resistant shell
- ▶ Anti wear



Item no.	Contents
58 10 20 01	

WELDING MASK

- ▶ Impact-resistant shell
- ▶ Anti wear



Item no.	Contents
58 10 20 02	

WELDING MASK, ADJUSTING INSIDE

- ▶ Filter size 110X92X11mm
- ▶ Windows size 90X40mm
- ▶ Ultraviolet ray transmittance rate 313-365nm<3.4x10-6
- ▶ Infrared ray transmittance rate 780-1300nm<0.0027%
- ▶ 1300-2000nm<0.0097%
- ▶ Dark shade range DIN9-13
- ▶ Light shade number DIN3
- ▶ Switching time 1/20000s from bright to dark
- ▶ Recovery time 0.6s to 1s from dark to bright
- ▶ Power supply solar cells
- ▶ Eye protection EN379 1/2/1
- ▶ Face protection EN175
- ▶ Auto-power on/off
- ▶ Net weight 460g±10g



Item no.	Contents
58 10 20 03	

WELDING MASK, ADJUSTING OUTSIDE

- ▶ Filter size 110X92X11mm
- ▶ Windows size 90X40mm
- ▶ Ultraviolet ray transmittance rate 313-365nm<3.4x10-6
- ▶ Infrared ray transmittance rate 780-1300nm<0.0027%
- ▶ 1300-2000nm<0.0097%
- ▶ Dark shade range DIN9-13
- ▶ Light shade number DIN3
- ▶ Switching time 1/20000s from bright to dark
- ▶ Recovery time 0.6s to 1s from dark to bright
- ▶ Power supply solar cells
- ▶ Eye protection EN379 1/2/1
- ▶ Face protection EN175
- ▶ Auto-power on/off
- ▶ Net weight 460g±10g



Item no. **Contents**
58 10 20 04

PROTECTIVE FACE SHIELD

- ▶ With visor to protect forehead
- ▶ Ratchet suspension and sweatband can be adjusted for extra comfort
- ▶ Protective shield can be turned up and fixed at any position
- ▶ PC plastic shield or wire mesh shield



Item no. **Contents**
58 10 20 07

WELDING MASK

- ▶ Impact-resistant shell
- ▶ Anti wear

CE DIN EN379
ANSI Z87



Item no. **Contents**
58 10 20 20

DUST RESPIRATOR

- ▶ CE approved
- ▶ PVC plastic body
- ▶ Single filter design



Item no. **Contents**
58 10 20 08

WELDING MASK

- ▶ Impact-resistant shell
- ▶ Anti wear

CE DIN EN379
ANSI Z87



Item no. **Contents**
58 10 20 21

PROTECTIVE FACE SHIELD

- ▶ Transparent PC plastic shield



Item no. **Contents**
58 10 20 05

DUST RESPIRATOR

- ▶ CE approved
- ▶ PVC plastic body
- ▶ Dual filters design



Item no. **Contents**
58 10 20 09

PROTECTIVE FACE SHIELD

- ▶ Wire mesh



CE

Item no. **Contents**
58 10 20 22

Item no. **Contents**
58 10 20 06





DUST RESPIRATOR

- ▶ CE approved
- ▶ PVC plastic body
- ▶ Dual filters design



Item no.	Contents
58 10 20 23	

WELDING GOGGLE

- ▶ Soft and light weight PVC frame
- ▶ Colored inorganic glass



Item no.	Contents
58 10 40 01	

SAFETY GOGGLE

- ▶ Soft and light weight PVC frame with air holes!
- ▶ Impact resistant
- ▶ Europe CE EN166 approved
- ▶ ANSI Z87.1 approved



Item no.	Contents
58 10 40 05	

DUST RESPIRATOR

- ▶ CE approved
- ▶ PVC plastic body
- ▶ Dual filters design



Item no.	Contents
58 10 20 24	

WELDING GOGGLE

- ▶ Flip design with open-close locking position
- ▶ Soft and light weight PVC frame
- ▶ Colored inorganic outer glass lens
- ▶ Transparent clear inner glass lens
- ▶ Protection grade: 5th Grade



Item no.	Contents
58 10 40 02	

SAFETY GOGGLE

- ▶ Soft and light weight PVC frame
- ▶ Fitting to face for comfort and protection from liquid



Item no.	Contents
58 10 40 06	

DUST CARTRIDGE

- ▶ ABS plastic shell body
- ▶ With built-in high filtration cotton



Item no.	Contents
58 99 00 01	

WELDING GOGGLE

- ▶ Flip design with open-close locking position
- ▶ Soft and light weight PVC frame
- ▶ Colored inorganic outer glass lens
- ▶ Transparent clear inner glass lens
- ▶ Protection grade: 5th Grade



Item no.	Contents
58 10 40 03	

SAFETY GOGGLE

- ▶ Design of curved frame gives good sight
- ▶ Four vent valves indirect ventilation design



Item no.	Contents
58 10 40 07	

CHEMICAL CARTRIDGE

- ▶ ABS plastic shell body
- ▶ With built-in high filtration active carbon



Item no.	Contents
58 99 00 02	

WELDING GOGGLE

- ▶ Single lens structure
- ▶ Soft and light weight PVC frame
- ▶ Wearing corrective glasses is viable
- ▶ Protection grade: 5th Grade



Item no.	Contents
58 10 40 04	

SAFETY GOGGLE

- ▶ Design of curved frame gives good sight
- ▶ Made from EVA material



Item no.	Contents
58 10 40 08	

SAFETY GLASSES	
<ul style="list-style-type: none"> ▶ CE-approved ▶ Full view design ▶ Impact resistant ▶ Wearing corrective glasses is viable 	
	
Item no.	Contents
58 10 40 09	

SAFETY GLASSES	
	
Item no.	Contents
58 10 40 22	

SAFETY GLASSES	
	
CE	
Item no.	Contents
58 10 40 26	

SAFETY GLASSES	
<ul style="list-style-type: none"> ▶ CE-approved to EN166 ▶ Expert quality made from impact resistant polycarbonate. ▶ Gives clear distortion free viewing. ▶ Adjustable leg of frame for comfortable use and fit 	
	
Item no.	Contents
58 10 40 10	

SAFETY GLASSES	
	
Item no.	Contents
58 10 40 23	

EAR MUFF	
<ul style="list-style-type: none"> ▶ Foldable design for convenient carry and store ▶ NRR: 25dB. 	
	
Item no.	Contents
58 10 60 01	

WELDING GOGGLE	
	
Item no.	Contents
58 10 40 20	

SAFETY GLASSES	
	
Item no.	Contents
58 10 40 24	

EAR MUFF	
<ul style="list-style-type: none"> ▶ Simple design, light weight for long-time use ▶ Europe EN352-1 standard ▶ NRR: 22dB 	
	
Item no.	Contents
58 10 60 02	

SAFETY GLASSES	
	
CE	
Item no.	Contents
58 10 40 21	

SAFETY GLASSES	
	
CE	
Item no.	Contents
58 10 40 25	





EAR MUFF

- ▶ Can match with many styles of safety helmets
- ▶ When not use, can be turned and fixed to safety helmet
- ▶ Europe EN352-3 standard
- ▶ NRR: 24dB



Item no.	Contents
58 10 60 03	

EAR MUFF



SNR=26DB

Item no.	Contents
58 10 60 20	

EAR MUFF



SNR=28DB

Item no.	Contents
58 10 60 21	

EAR MUFF



SNR=25DB

Item no.	Contents
58 10 60 22	

EAR PLUG



Item no.	Contents
58 10 60 23	

EAR PLUG

- ▶ Supple tube
- ▶ Can be cleaned and used repeatedly
- ▶ NRR: 26dB



Item no.	Contents
58 10 60 04	

EAR PLUG

- ▶ Made from polyurethane foam, smooth and soft



Item no.	Contents
58 10 60 05	

DUST MASK

- ▶ Plane-type mask made of PP
- ▶ With active carbon for high filtration



Item no.	Contents
58 10 80 01	

DUST MASK

- ▶ CE approval
- ▶ Simple to use.
- ▶ Low breathing resistance with high efficiency
- ▶ Suitable to general dust workshops, garden, housecleaning, motorcycle riders etc.



Item no.	Contents
58 10 80 02	

DUST MASK

- ▶ CE approval
- ▶ Special 4 ply plated design, high filtration and static electricity material, and high efficient active carbon material to absorb. Suitable to paper industrial agriculture, drug industrial, chemical engineering power generating, electronic, coating, metal annealing etc. To resist acid and vapor, such as H2S, SO2, H2, N2 and micro dust.



Item no.	Contents
58 10 80 03	

DUST MASK

- ▶ CE approval
- ▶ With breathing valve
- ▶ Special 4 ply plated design, high filtration and static electricity material, and high efficient active carbon material to absorb. Silicon valve equipped to resist the dust. Suitable to paper industrial, shipbuilding, paper industrial, agriculture, chemical engineering power generating, electronic, coating, metal annealing and hot/heavy labor environments etc. To resist acid and vapor, such as H2S, SO2, H2, N2 and micro dust.



Item no.	Contents
58 10 80 04	

DUST MASK

- ▶ Low breathing resistance with high efficiency
- ▶ Suitable to general dust workshops, garden, housecleaning, motorcycle riders etc.



Item no.	Contents
58 10 80 05	

DUST MASK

- ▶ Low breathing resistance with high efficiency
- ▶ Suitable to general dust workshops, garden, housecleaning, motorcycle riders etc.



Item no.	Contents
58 10 80 06	

DUST MASK

- ▶ Replaceable Plastic shelled filter disc for convenient and economic use



Item no.	Contents
58 10 80 07	

DUST MASK



CE EN149:2001
FFP2 NR

Item no.	Contents
58 10 80 20	

DUST MASK



CE EN149:2001
FFP2 NR

Item no.	Contents
58 10 80 21	

DUST MASK



CE EN149:2001
FFP2 NR

Item no.	Contents
58 10 80 22	

DUST MASK



Item no.	Contents
58 10 80 23	

3PCS PROTECTORS



Item no.	Contents
58 10 80 24	

2PCS PROTECTORS

- ▶ Including a dust mask and safety goggle



Item no.	Contents
58 10 80 25	

3PCS PROTECTORS

- ▶ Including a dust mask, safety goggle and ear plug



Item no.	Contents
58 10 80 26	

3PCS PROTECTORS

- ▶ Including a dust mask, safety goggle and ear plug



Item no.	Contents
58 10 80 27	



REFLECTOR VEST

▶ 100% polyester fabric and 5cm width high reflective tape





Item no.	Contents
58 20 00 01	S-XXXL

REFLECTOR COAT

▶ 100% polyester fabric and 5cm width high reflective tape





Item no.	Contents
58 20 00 04	S-XXXL

JUMPSUIT



Item no.	Contents
58 20 50 03	Polyester/PVC material Cotton material

REFLECTOR VEST

▶ 100% polyester fabric and 5cm width high reflective tape





Item no.	Contents
58 20 00 02	S-XXXL

RAIN SUIT

▶ Including hood, coat and trousers
▶ With high reflective tape



Item no.	Contents
58 20 50 01	Polyester/PVC material Nylon/PVC material

PROTECTIVE CLOTHING

▶ Including hood, shoes and jumpsuit.



Item no.	Contents
58 20 50 04	SS/S/M/L/XL/XXL/XXXL

REFLECTOR VEST

▶ 100% polyester mesh fabric and 5cm width PVC reflective tape





Item no.	Contents
58 20 00 03	S-XXXL

RAIN SUIT

▶ Including hood, coat and trousers



Item no.	Contents
58 20 50 02	Polyester/PVC material Nylon/PVC material

BIB PANTS

▶ 60% Cotton, 40% Polyester, 240gsm 3M reflex inserts, braces release system. Elasticated waist with quick and adjustable knee and leg ergonomic design

Pockets:
Telephone pocket, breast pocket with zip, pen pocket, wide front pockets, coin pocket, two side pocket and back pockets ruler pocket, hammer loop.



Special Design for night working

Item no.	Contents
58 20 50 20	

labour suit and work pants

- ▶ 35% Cotton, 65% Polyester, 240gsm
- labour suit Pockets:**
Two breast pockets, pen pocket side pocket.
- work pants Pockets:**
Two multifunctional Tool Pocket, two wide front pockets and back pockets. Four side pockets, ruler pocket, pen pocket



- Water RESISTANT
- ANTI ACID
- ANTI STATIC

Special Design for
garageman or
craftman etc.

Item no.	Contents
58 20 50 21	

RAINCOATS&TROUSERS

- ▶ Material: 190T Polyester (OUTER)
Polyester mesh (INNER)
- Details:**
Outer fabric: breathable(2000),
windproof and waterproof(2000)
Main seams are sealed,with elastic



Item no.	Contents
58 20 50 23	

RAINCOATS&TROUSERS

- ▶ Material: 190T Polyester (OUTER)
Polyester mesh (INNER)
- Details:**
Outer fabric: breathable(2000),
windproof and waterproof(2000)
Main seams are sealed,with elastic



Item no.	Contents
58 20 50 25	

JUMPSUIT

- ▶ 35% Cotton, 65% Polyester, 240gsm Elasticated waist
- Pockets:**
Telephone pocket, breast pocket with zip, two wide front pockets and backpockets. Two side pockets, ruler pocket



- WATER RESISTANT
- FIRE RESISTANT

Special Design for
garageman or
lumberman etc.

Item no.	Contents
58 20 50 22	

RAINCOATS&TROUSERS

- ▶ Material: 190T Polyester
Polyester mesh
- Details:**
Outer fabric: breathable(2000),
windproof and waterproof(2000)
Main seams are sealed,with elastic



Item no.	Contents
58 20 50 24	

NYLON CHEST WADER

- ▶ **Product Specification :**
70D Nylon fabric, PVC coating. Strictly waterproof test for 100% of production. Adjustable elastic suspenders, High quality anti-slip PVC boots; Doubleneedle stitching. Hermetic waterproof tape inside on all seam; Any logos are available according to customer's requirement. Optional Accessories: outer chest pocket, waist belt, felt sole Size: EU 38 to 46, UK 4 to 12



The both nylon fabric
and PVC boots passed
the TUV PAHs testing

Item no.	Contents
58 20 50 26	

ENERGY ABSORBER WITH CONNECTOR

EN 355 EN354

- Broken streight 200-600KG
- Breaking force 25KN
- Minimum Ground clearance
from Anchorage Point: 6M

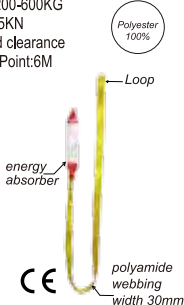

Item no.	Contents
58 20 50 27	

SAFETY HARNESS

EN 361

- Webbing 45mm
- I fall arrest dorsal D-ring
- Adjustable shoulder, thigh, and chest strap

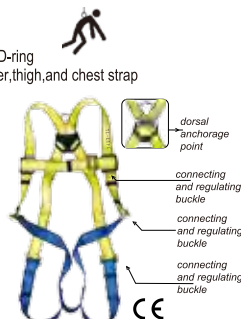

Item no.	Contents
58 20 50 28	

VEST

- ▶ 35% Cotton, 65% Polyester, 240gsm

- Pockets:**
Telephone pocket, Two breast pockets with zip, Two wide front pockets



Special Design for
leisure time wearing

Item no.	Contents
58 20 50 29	



WORKING GLOVES

- ▶ Latex coated
- ▶ Cotton liner
- ▶ Knit wrist



Item no. Contents

58 30 00 01

WORKING GLOVES

- ▶ Latex coated
- ▶ Cotton liner
- ▶ Knit wrist
- ▶ With dots in palm
- ▶ Oil resistant



Item no. Contents

58 30 00 05 7"/8"/9"/10"/11"

GARDEN GLOVES

- ▶ Bleached cotton gloves with PVC dots on palm



Item no. Contents

58 30 00 09 8/M,9/L,10/XL/11/XXL

WORKING GLOVES

- ▶ Latex coated
- ▶ Cotton liner
- ▶ Knit wrist



Item no. Contents

58 30 00 02

WORKING GLOVES

- ▶ Latex coated
- ▶ Cotton liner
- ▶ Soft and comfortable
- ▶ Oil resistant



Item no. Contents

58 30 00 06

GARDEN GLOVES

- ▶ White cotton gloves with PVC dots on palm
- ▶ Knit wrist



Item no. Contents

58 30 00 10 8/M,9/L,10/XL

WORKING GLOVES

- ▶ Nylon coated



Item no. Contents

58 30 00 03 7"/8"/9"/10"/11"

PU WORKING GLOVES

- ▶ PU material
- ▶ Antistatic



Item no. Contents

58 30 00 07

GARDEN GLOVES

- ▶ PVC imitation



Item no. Contents

58 30 00 11

WORKING GLOVES

- ▶ Latex coated
- ▶ Cotton liner
- ▶ Knit wrist



Item no. Contents

58 30 00 04

PVC WORKING GLOVES

- ▶ Smooth PVC coated
- ▶ Cotton liner



Item no. Contents

58 30 00 08 27mm 30mm 35mm
40mm 45mm 60mm

LEATHER WORKING GLOVES

- ▶ Pig/cow split leather
- ▶ Palm lined



Item no. Contents

58 30 00 12

SAFETY AND PROTECTION

WELDING GLOVES

- ▶ Cow split leather
- ▶ Lengthened, for better protection



Item no.	Contents
58 30 00 13	14"

MECHANIC'S GLOVES

- ▶ Micro fibre palm
- ▶ Sheep leather knuckle
- ▶ Lycra cloth for the back of hand
- ▶ Elastic wrist with velcro closure



Item no.	Contents
58 30 00 16	

WORKING GLOVES



4122 **CE EN388**

Item no.	Contents
58 30 00 20	

DRIVING GLOVES

- ▶ CE Approved
- ▶ Light yellow cow grain leather
- ▶ Keystone thumb, unlined



Item no.	Contents
58 30 00 14	10"

MECHANIC'S GLOVES

- ▶ Sheep leather knuckle
- ▶ Lycra cloth for the back of hand



Item no.	Contents
58 30 00 17	

WORKING GLOVES



Item no.	Contents
58 30 00 21	

MECHANIC'S GLOVES

- ▶ Brown pig grain leather
- ▶ Reinforced pig grain leather palm and knuckle
- ▶ Black stretch knit back
- ▶ Elastic wrist with velcro closure.



Item no.	Contents
58 30 00 15	

WORKING GLOVES

- ▶ Cut resistance
- ▶ White and black mixed dyneema liner
- ▶ Palm coated grey PU



Item no.	Contents
58 30 00 18	

WORKING GLOVES



CE EN388

Item no.	Contents
58 30 00 22	



PLASTIC GLOVES

- ▶ PE material
- ▶ Convenient and economic



Item no.	Contents
58 30 00 19	

WORKING GLOVES



4143 **CE EN388**

Item no.	Contents
58 30 00 23	



SHOE COVER

- ▶ PE material
- ▶ Convenient and economic



Item no.	Contents
58 30 20 01	

SAFETY SHOES

- ▶ UPPER:high quality PU leather
- ▶ LINING:breathable fabric
- ▶ INSOLE:antistatic,full piece
- ▶ OUTSOLE:PU/PU
- ▶ Light weight for comfort



Item no.	Contents
58 30 00 04	36-48

SAFETY SHOES



EN ISO 240345:2004

Item no.	Contents
58 30 00 07	

SAFETY SHOES

- ▶ UPPER:high quality leather
- ▶ LINING:non-woven fabric
- ▶ INSOLE:antistatic,full piece
- ▶ OUTSOLE:PU/TPU
- ▶ Light weight for comfort
- ▶ Oils,acids,alkalis and fats resistant



Item no.	Contents
58 30 20 02	36-48

PU SAFETY BOOTS

- ▶ GREEN/BLACK
- ▶ Height:400mm-410mm
- ▶ PU injection,polyester lining
- ▶ 30% lighter than a traditional boots
- ▶ Acids, hydrocarbon and animal fats resistant
- ▶ For cold stores,agriculture,skiing stations,food industries and general construction etc.



EN ISO20347:2004

Item no.	Contents
58 30 00 05	37-47(4-13)

SAFETY SHOES



EN ISO 240345:2004

Item no.	Contents
58 30 00 08	

SAFETY SHOES

- ▶ UPPER:high quality buffalo leather
- ▶ LINING:non-woven fabric
- ▶ INSOLE:antistatic,full piece
- ▶ OUTSOLE:PU/TPU
- ▶ Light weight for comfort
- ▶ Oils,acids,alkalis and fats resistant



Item no.	Contents
58 30 00 03	36-48

SAFETY BOOTS

- ▶ Yellow or Black color,
- ▶ Height:370mm-395mm
- ▶ PVC/Nitrile injection
- ▶ Oils,acids,alkalis and fats resistant
- ▶ For mining,oil field,farming,Chemical related industries,general construction etc.



EN345 S5

Item no.	Contents
58 30 00 06	37-47(4-13)

KNEE PADS

- ▶ Professional design for comfortable use
- ▶ Soft and flexible material gives your kness well protection



Item no.	Contents
58 30 40 01	

KNEE PADS

- ▶ Economical design for general use
- ▶ Plastic material



Item no.	Contents
58 30 40 02	

KNEE PADS

- ▶ Thick foam with Nylon cloth for long use
- ▶ With grooved transparent plastic curved caps



Item no.	Contents
58 30 40 05	

KNEE PADS



Item no.	Contents
58 30 40 08	

KNEE PADS

- ▶ Thick EVA material with oxford cloth



Item no.	Contents
58 30 40 03	

DELUXE KNEE PADS

- ▶ Grooved cap design helps prevent thread abrasion
- ▶ Durable knee protection, ergonomic design
- ▶ suitable for most work when kneeling is required
- ▶ Thick foam centre padding for maximum comfort with plastic caps
- ▶ Comfortable durable elastic straps with hook and loop fastening



Item no.	Contents
58 30 40 06	

KNEE PADS



Item no.	Contents
58 30 40 09	

KNEE PADS

- ▶ Thick foam with Nylon cloth for long use
- ▶ With grooved transparent plastic curved caps



Item no.	Contents
58 30 40 04	

KNEE PADS

- ▶ A pair of soft cap knee pads with 40mm
- ▶ elasticated quick fastening straps
- ▶ Thick foam centre padding for maximum protection
- ▶ Ideal for carpet layers, gardeners and DIY



Item no.	Contents
58 30 40 07	

KNEE PADS



Item no.	Contents
58 30 40 10	



151PC EYE BOLT ASSORTMENT

► Contents: 60x1-1/8", 50x1-5/8", 12x2-1/2", 12x1-13/16", 12x1-15/16", 5x3-3/8"



Item no. Contents

60 90 00 01

500PC RIVET ASSORTMENT

► Contents: 125x1/8"x1/4", 125x1/8"x5/16", 125x1/8"x3/8", 125x1/8"x5/8"



Item no. Contents

60 90 00 02

150PC HITCH PIN ASSORTMENT

► Contents: 40x2.4x31, 30x2.0x33, 25x2.0x40, 25x2.8x42, 20x3.5x45, 8x4.0x75



Item no. Contents

60 90 00 03

720PC WASHER ASSORTMENT

► Contents: 50x6#, 40x1/4", 50x8#, 30X5/16", 50x10#, 20x3/8"



Item no. Contents

60 90 00 04

555PC COTTER PIN ASSORTMENT

► Contents: 150x1.6x25, 150x2.4x25, 100x2.4x38, 75x3.2x32, 50x3.2x50, 30x4.0x64



Item no. Contents

60 90 00 05

200PC SPRING ASSORTMENT

► Contents: 12x4.0x79.5, 8x4.5x44.5, 10x5.0x20.5, 10x5.5x25.5, 10x6.5x22.0, 10x7.0x38.0, 12x7.0x51.0, 8x8.0x28.5, 10x8.0x31.5, 12x8.0x44.5, 10x8.5x36.5, 12x8.5x47, 10x5.5x17.5, 10x5.5x38.0, 10x6.5x10.0, 10x7.0x12.5, 10x7.0x19.0, 8x9.0x35.0, 6x9.5x16.0, 12x9.5x19.0



Item no. Contents

60 90 00 06

110PC METRIC HYDRAULIC GREASE FITTING ASSORTMENT

► Contents: 60xM6x1, 5xM6x1 (45°), 5xM6x1 (90°), 10xM8x1.25, 5xM8x1.25 (45°), 5xM8x1.25 (90°), 5xM10x1.5 (45°), 5xM10x1.5 (90°), 10xM10x1.5



Item no. Contents

60 90 00 07

26PC HOSE CLIP ASSORTMENT

► Contents: 8x16mm, 6x22mm, 4x25mm, 2x28mm, 2x35mm, 4x40mm



Item no. Contents

60 90 00 08

225PC METRIC O-RING ASSORTMENT

► Contents: 20x3x1, 20x4x1, 20x4.5x2, 20x5x2, 20x6x2, 20x6x2.5, 5x13x3, 5x14x2.5, 5x17x2.5, 5x13x4, 5x20x2, 5x22x2, 20x6x3, 20x7x2, 20x8x2, 5x9x2, 5x10x2, 5x12x3



Item no. Contents

60 90 00 09

127PC SHRINKABLE TUBING SET

► Contents: 30x2.0x40mm, 25x2.5x40mm, 20x3.5x40mm, 20x5.0x40mm, 16x7.0x80mm, 8x10.0x80mm, 8x13.0x85mm



Item no. Contents

60 90 00 10

150PC COPPER WASHER ASSORTMENT

- ▶ Contents: 10x5x10x1, 10x8x12x1, 10x11x17x1.5, 10x6x10x1, 10x10x16x1, 10x14x18x1, 10x7x10x1, 10x10.5x17x1.5, 10x12x20x1.5, 10x12.5x20x1.5, 10x15x20x2, 10x16.5x24x2, 10x14x20x1.5, 10x16x22x2, 10x17.5x24x2



Item no.	Contents
60 90 00 11	

141PC RUBBER SEALING WASHER ASSORTMENT

- ▶ Contents: 10x1/2"x10mm, 10x3/4"x24mm, 5x1/2"x10mm, 10x3/8"x8mm, 10x1/2", 5x1", 5x3/4"x8mm, 10x3/4" - 11x24x2mm, 5x3/8"x10mm, 10x21x17mm, 3x1-1/2" 27x38mm, 3x1-1/4" 30x39mm, 10x1/2"x17mm, 5x1/2" 9x19mm, 10x3/4", 10x3/4" 16x24mm, 10x1/2" 12x13mm



Item no.	Contents
60 90 00 12	

CHIPBOARD SCREWS

- ▶ Pozidriver.Zinc plated
- ▶ Quantities of same size in a strong polybag with lable



Item no.	Size	Qty / polybag
60 24 60 07	3.5x30mm	200pcs
60 24 60 08	3.5x35mm	200pcs
60 24 60 09	4.0x30mm	200pcs
60 24 60 10	4.0x40mm	200pcs
60 24 60 11	4.0x50mm	200pcs
60 24 60 12	5.0x50mm	100pcs
60 24 60 13	5.0x60mm	100pcs
60 24 60 14	5.0x80mm	100pcs
60 24 60 15	6.0x100mm	50pcs

HEXAGON HEAD SCREWS

- ▶ DIN933
- ▶ Grade: 4.8, 8.8
- ▶ Material: Carbon steel, stainless steel
- ▶ Finish: Zinc-plated / black finish



Item no.	Size	Qty / polybag
60 10 00 01	M3X10	500PCS
60 10 00 02	M4X12	500PCS
60 10 00 03	M5X16	200PCS
60 10 00 04	M6X20	200PCS
60 10 00 05	M8X30	200PCS
60 10 00 06	M10X40	100PCS
60 10 00 07	M12X50	100PCS
60 10 00 08	M14X60	50PCS

HEXAGON SOCKET HEAD CAP SCREWS

- ▶ DIN933
- ▶ Grade: 4.8, 8.8
- ▶ Material: Carbon steel, stainless steel
- ▶ Finish: Zinc-plated / black finish



Item no.	Size	Qty / polybag
60 10 20 01	M3X10	500PCS
60 10 20 02	M4X12	500PCS
60 10 20 03	M5X16	200PCS
60 10 20 04	M6X20	200PCS
60 10 20 05	M8X30	200PCS
60 10 20 06	M10X40	100PCS
60 10 20 07	M12X50	100PCS
60 10 20 08	M14X60	50PCS

HEXALOBULAR COUNTERSUNK HEAD SCREWS

- ▶ DIN7991
- ▶ Grade: 10.9
- ▶ Material: Alloy steel
- ▶ Finish: Natural, black



Item no.	Size	Qty / polybag
60 10 20 09	M3X10	200PCS
60 10 20 10	M3X12	200PCS
60 10 20 11	M4X12	200PCS
60 10 20 12	M4X16	200PCS
60 10 20 13	M5X16	200PCS
60 10 20 14	M5X20	200PCS
60 10 20 15	M6X25	200PCS
60 10 20 16	M6X30	200PCS
60 10 20 17	M8X40	200PCS
60 10 20 18	M8X45	200PCS
60 10 20 19	M10X50	100PCS

HEXAGON NUTS

- ▶ DIN934
- ▶ Grade: 4.8, 8.8, 10.9
- ▶ Material: Carbon steel, stainless steel
- ▶ Finish: Zinc-plated



Item no.	Size	Qty / polybag
60 14 00 01	M3	250PCS
60 14 00 02	M4	250PCS
60 14 00 03	M5	250PCS
60 14 00 04	M6	250PCS
60 14 00 05	M8	250PCS
60 14 00 06	M10	250PCS
60 14 00 07	M12	100PCS
60 14 00 08	M14	100PCS
60 14 00 09	M16	100PCS
60 14 00 10	M20	50PCS

HEXAGON DOMED CAP NUTS

- ▶ DIN1587
- ▶ Material: Carbon steel, stainless steel
- ▶ Finish: Zinc-plated



Item no.	Size	Qty / polybag
60 14 20 01	M3	250PCS
60 14 20 02	M4	200PCS
60 14 20 03	M5	200PCS
60 14 20 04	M6	200PCS
60 14 20 05	M8	200PCS
60 14 20 06	M10	100PCS
60 14 20 07	M12	50PCS
60 14 20 08	M16	25PCS
60 14 20 09	M20	10PCS

HEXAGON FALANGE NUTS

- ▶ DIN6923
- ▶ Material: Carbon steel
- ▶ Finish: Zinc-plated



Item no.	Size	Qty / polybag
60 14 20 10	M5	250PCS
60 14 20 11	M6	250PCS
60 14 20 12	M8	250PCS
60 14 20 13	M10	100PCS



PREVAILING TORQUE TYPE HEXAGON NUTS WITH NON-METALLIC INSERT

- ▶ DIN985
- ▶ Material: Chrome-plated carbon steel, stainless steel



Item no.	Size	Qty / polybag
60 14 40 01	M3	250PCS
60 14 40 02	M4	250PCS
60 14 40 03	M5	250PCS
60 14 40 04	M6	250PCS
60 14 40 05	M8	250PCS
60 14 40 06	M10	200PCS
60 14 40 07	M12	100PCS
60 14 40 08	M14	100PCS
60 14 40 09	M16	50PCS
60 14 40 10	M20	25PCS

CONNECTION NUTS

- ▶ DIN6334
- ▶ Material: Zinc-plated carbon steel



Item no.	Size	Qty / polybag
60 14 00 11	M6X30	10PCS
60 14 00 12	M8X35	10PCS
60 14 00 13	M10X45	5PCS
60 14 00 14	M12X55	5PCS

PLAIN WASHERS

- ▶ DIN125
- ▶ Material: Zinc-plated carbon steel stainless steel



Item no.	Size	Qty / polybag
60 50 20 01	M3	250PCS
60 50 20 02	M4	250PCS
60 50 20 03	M5	250PCS
60 50 20 04	M6	250PCS
60 50 20 05	M8	250PCS
60 50 20 06	M10	200PCS
60 50 20 07	M12	150PCS
60 50 20 08	M14	100PCS
60 50 20 09	M16	100PCS
60 50 20 10	M18	100PCS
60 50 20 11	M20	100PCS

PLAIN WASHERS

- ▶ Pozidriver, Zinc plated
- ▶ Quantities of same size in a strong polybag with lable



Item no.	Size	Qty / polybag
60 50 20 12	M3	250PCS
60 50 20 13	M4	250PCS
60 50 20 14	M5	250PCS
60 50 20 15	M6	250PCS
60 50 20 16	M8	250PCS
60 50 20 17	M10	200PCS
60 50 20 18	M12	200PCS
60 50 20 19	M14	100PCS
60 50 20 20	M16	100PCS
60 50 20 21	M18	100PCS
60 50 20 22	M20	100PCS

SPRING LOCK WASHERS WITH SQUARE ENDS

- ▶ DIN127B
- ▶ Carbon steel / stainless steel
- ▶ Zinc-plated / black finish



Item no.	Size	Qty / polybag
60 50 00 01	M3	250PCS
60 50 00 02	M4	250PCS
60 50 00 03	M5	250PCS
60 50 00 04	M6	250PCS
60 50 00 05	M8	200PCS
60 50 00 06	M10	200PCS
60 50 00 07	M12	150PCS
60 50 00 08	M14	100PCS
60 50 00 09	M16	100PCS
60 50 00 10	M18	100PCS
60 50 00 11	M20	100PCS

SPRING LOCK WASHERS WITH SQUARE ENDS

- ▶ DIN127B
- ▶ Carbon steel / stainless steel
- ▶ Zinc-plated / black finish



Item no.	Size	Qty / polybag
60 54 40 01	8	250PCS
60 54 40 02	10	250PCS
60 54 40 03	12	250PCS
60 54 40 04	14	100PCS
60 54 40 05	16	100PCS
60 54 40 06	20	100PCS
60 54 40 07	30	100PCS

CHIPBOARD SCREWS

- ▶ Pozidriver
- ▶ Zinc plated
- ▶ Quantities of same size in a strong polybag with lable



Item no.	Size	Qty / polybag
60 24 60 16	M3X30	200PCS
60 24 60 17	M3X35	200PCS
60 24 60 18	M3.5X20	200PCS
60 24 60 19	M3.5X30	200PCS
60 24 60 20	M3.5X35	200PCS
60 24 60 21	M3.5X40	200PCS
60 24 60 22	M4X30	200PCS
60 24 60 23	M4X40	200PCS
60 24 60 24	M4X50	200PCS

HEXAGON HEAD WOOD SCREWS

- ▶ DIN571
- ▶ Steel and steel zinc plated, hot dip galvanized



Item no.	Size	Qty / polybag
60 22 40 01	M5X30	200PCS
60 22 40 02	M5X40	200PCS
60 22 40 03	M5X50	200PCS
60 22 40 04	M6X30	200PCS
60 22 40 05	M6X60	200PCS
60 22 40 06	M6X70	200PCS
60 22 40 07	M8X30	200PCS
60 22 40 08	M8X50	200PCS
60 22 40 09	M8X80	200PCS
60 22 40 10	M8X150	50PCS
60 22 40 11	M10X60	100PCS
60 22 40 12	M10X80	100PCS
60 22 40 13	M10X100	100PCS
60 22 40 14	M10X140	50PCS
60 22 40 15	M10X180	50PCS
60 22 40 16	M10X200	50PCS

THREADED RODS

- ▶ Steel and steel zinc plated, hot dip galvanized, Stainless steel



Item no.	Size	Qty / polybag
60 18 00 01	M3X1M	
60 18 00 02	M5X1M	
60 18 00 03	M8X2M	
60 18 00 04	M10X1M	
60 18 00 05	M12X1M	
60 18 00 06	M16X2M	

DROP IN ANCHORS

- ▶ Steel, stainless steel and other metallic
- ▶ Used for concrete and natural hard stone



Item no.	Size	Qty / polybag
60 26 20 01	8XM6X25MM	100PCS
60 26 20 02	10XM8X30MM	100PCS
60 26 20 03	12XM10X40MM	100PCS
60 26 20 04	16XM12X50MM	50PCS
60 26 20 05	20XM16X65MM	25PCS

WEDGE ANCHORS

- ▶ Material: Steel, stainless steel and other metallic
- ▶ Used for concrete and compact stone
- ▶ Application: Metal construction, metal profile, base, supporting plate, bracket, etc.



Item no.	Size	Qty / polybag
60 26 20 06	M6X65	100PCS
60 26 20 07	M8X75	100PCS
60 26 20 08	M10X90	100PCS
60 26 20 09	M12X110	50PCS

HIT ANCHORS

- ▶ Material: Steel, stainless steel and other metallic
- ▶ Used for concrete and compact stone
- ▶ Application: Metal construction, metal profile, base, supporting plate, bracket, etc.



Item no.	Size	Qty / polybag
60 26 20 10	M6X60	100PCS
60 26 20 11	M8X70	100PCS
60 26 20 12	M10X80	100PCS
60 26 20 13	M12X90	50PCS

NYLON NAIL ANCHORS

- ▶ Material: Made by polyimide
- ▶ Application: light load fasting in wood, hardboard, plaster, metal, cinder block, brick, slate, marble, plastic, tile, glass and concrete.



Item no.	Size	Qty / polybag
60 26 20 14	5.0X20	100PCS
60 26 20 15	5.0X40	100PCS
60 26 20 16	6.5X25	100PCS
60 26 20 17	6.5X40	100PCS

HOLLOW WALL ANCHORS

- ▶ Material: Steel and cold roller sheet, screws head can be in cross recessed pand head, ring hook, angle hook, eyelet
- ▶ Application: fasten mirrors, pictures, cabinets, curtain-drapes-shelf brackets to wall of plaster over wood lath or metal lath wall board, gypsum or cinder block hollow tiles, etc.



Item no.	Size	Qty / polybag
60 26 20 18	4X20	100PCS
60 26 20 19	5X37	100PCS
60 26 20 20	6X52	100PCS
60 26 20 21	8X37	100PCS

SLIGHT SLEEVE ANCHORS

- ▶ Material: Steel and cold roller shetet, screws head can be in cross recessed pand head, ring hook, angle hook, eyelet
- ▶ Application: fixing concrete, solida brick, perforated brick, hollow brick



Item no.	Size	Qty / polybag
60 26 20 22	M5X60X35	50PCS
60 26 20 23	M6X70X40	25PCS
60 26 20 24	M8X90X50	25PCS
60 26 20 25	M10X110X60	10PCS

SPRING TOGGLE ANCHORS

- ▶ Material: Steel or stainless steel any screw head available
- ▶ Application: for fixing to cavity walls and ceiling of low structural strength



Item no.	Size	Qty / polybag
60 26 20 26	M4X100	

SCREW PLUG

- ▶ Material: polyimide
- ▶ Application: used for building material.



Item no.	Size	Qty / polybag
60 26 00 01	5MM	250PCS
60 26 00 02	6MM	250PCS
60 26 00 03	8MM	250PCS
60 26 00 04	10MM	250PCS

NYLON FRAME /HAMMER ANCHORS

- ▶ Material: Nylon, plastic, metallic etc.
- ▶ Application: Frame fixing, such as windows and doors



Item no.	Size	Qty / polybag
60 26 20 27	4X45MM	100PCS
60 26 20 28	5X65MM	100PCS
60 26 20 29	5X85MM	100PCS

IMPALE ANCHORS



Item no.	Size	Qty / polybag
60 20 90 01	8X80	250
60 20 90 02	8X90	250
60 20 90 03	10X90	250
60 20 90 04	10X120	250

CONCRETE NAIL

- ▶ Material: Steel
- ▶ Zinc plated



Item no.	Size	Qty / polybag
60 20 90 05	2X40MM	200PCS
60 20 90 06	2.5X50MM	200PCS
60 20 90 07	3X70MM	100PCS
60 20 90 08	3.5X90MM	100PCS
60 20 90 09	4.0X120MM	100PCS



HOSE CLAMP

► Material: Steel or stainless steel



Item no.	Size	Qty / polybag
60 75 00 01	15-24MM	10PCS
60 75 00 02	22-32MM	10PCS
60 75 00 03	32-44MM	10PCS
60 75 00 04	38-50MM	10PCS
60 75 00 05	44-56MM	10PCS

SINGLE-HEAD POWER HOSE CLAMP

► Material: Steel or stainless steel



Item no.	Size	Qty / polybag
60 75 00 06	29-31MM	10PCS
60 75 00 07	32-35MM	10PCS
60 75 00 08	40-43MM	10PCS
60 75 00 09	52-55MM	10PCS

3M STAINLESS STEEL HOSE CLAMP



Item no.	Size	Qty / polybag
60 75 00 10	3MM	

50 PCS HOSE CLAMP



Item no.	Size	Qty / polybag
60 90 00 14		

SQUARE HOOK

► Material: Carbon steel
► Finish: Zinc-plated



Item no.	Size	Qty / polybag
60 99 00 01	2.4X25MM	100PCS
60 99 00 02	3.2X40MM	100PCS
60 99 00 03	4.0X50MM	100PCS
60 99 00 04	5.0X60MM	100PCS

CUP HOOK

► Material: Carbon steel
► Finish: Zinc-plated



Item no.	Size	Qty / polybag
60 99 00 05	2.4X12/25MM	100PCS
60 99 00 06	3.2X20/40MM	100PCS
60 99 00 07	4.0X30/55MM	100PCS
60 99 00 08	4.4X30/60MM	100PCS

SCREW EYES

► Material: Carbon steel
► Finish: Zinc-plated



Item no.	Size	Qty / polybag
60 99 00 09	2.4X12X5MM	100PCS
60 99 00 10	3.2X16X8MM	100PCS
60 99 00 11	4.0X30X12MM	100PCS
60 99 00 12	4.4X30X16MM	100PCS

BLIND RIVET

► DIN7337A
► Steel and Aluminum



Item no.	Size	Qty / polybag
60 35 00 01	2.4X8MM	500PCS
60 35 00 02	3.2X10MM	500PCS
60 35 00 03	4.0X12MM	250PCS
60 35 00 04	4.8X16MM	250PCS

INDUSTRIAL NAIL(MULTI TYPE)

► Material: steel



Item no.	Size	Qty / polybag
60 30 00 01	6MM	CROWN NAIL
60 30 00 02	8MM	
60 30 00 03	10MM	
60 30 00 04	12MM	

INDUSTRIAL NAIL

► Material: Carbon steel



Item no.	Size	Qty / polybag
60 30 40 01	20MM	
60 30 40 02	30MM	
60 30 40 03	40MM	

BOW SHACKLE

► Material: Steel, stainless steel



Item no.	Size	Qty / polybag
63 35 00 01	6MM	25PCS
63 35 00 02	8MM	25PCS
63 35 00 03	10MM	25PCS
63 35 00 04	12MM	25PCS

DEE SHACKLE

► Material: Steel, stainless steel



Item no.	Size	Qty / polybag
63 35 00 05	5MM	25PCS
63 35 00 06	6MM	25PCS
63 35 00 07	8MM	25PCS
63 35 00 08	10MM	25PCS

TURNBUCKLE WITH HOOK AND EYE

- ▶ DIN1480
- ▶ Material: Steel, stainless steel



Item no.	Size	Qty / polybag
63 35 10 01	M6	10PCS
63 35 10 02	M8	10PCS
63 35 10 03	M10	5PCS
63 35 10 04	M12	5PCS

TURNBUCKLE WITH HOOK AND HOOK

- ▶ DIN1480
- ▶ Material: Steel, stainless steel



Item no.	Size	Qty / polybag
63 35 10 05	M6	10PCS
63 35 10 06	M10	5PCS
63 35 10 07	M12	5PCS
63 35 10 08	M16	5PCS

TURNBUCKLE WITH EYE AND EYE

- ▶ Material: Steel, stainless steel



Item no.	Size	Qty / polybag
63 35 10 09	M8	10PCS
63 35 10 10	M10	5PCS
63 35 10 11	M16	5PCS
63 35 10 12	M20	5PCS

WIRE ROPE CLIP

- ▶ DIN741
- ▶ Material: Steel, stainless steel



Item no.	Size	Qty / polybag
63 35 20 01	3MM	100PCS
63 35 20 02	5MM	100PCS
63 35 20 03	8MM	100PCS
63 35 20 04	10MM	50PCS

SNAP HOOK

- ▶ Material: Steel, stainless steel



Item no.	Size	Qty / polybag
63 35 30 01	5X50MM	100PCS
63 35 30 02	6X60MM	100PCS
63 35 30 03	8X80MM	100PCS

SNAP HOOK WITH SCREW

- ▶ Material: Steel, stainless steel



Item no.	Size	Qty / polybag
63 35 30 04	4X40MM	100PCS
63 35 30 04	5X50MM	100PCS
63 35 30 05	6X60MM	100PCS

ALUMINUM SNAP HOOK

- ▶ Material: Aluminum



Item no.	Size	Qty / polybag
63 35 30 07	5X50MM	100PCS
63 35 30 08	6X60MM	100PCS
63 35 30 09	7X70MM	100PCS
63 35 30 10	8X80MM	100PCS
63 35 30 11	10X100MM	100PCS

SWIVEL SNAP HOOK

- ▶ Material: zinc alloy



Item no.	Size	Qty / polybag
63 35 30 12	5/8"	100PCS
63 35 30 13	3/4"	100PCS
63 35 30 14	1"	100PCS

SWIVEL SNAP HOOK

- ▶ Material: zinc alloy



Item no.	Size	Qty / polybag
63 35 30 15	3/4"	100PCS
63 35 30 16	7/8"	100PCS
63 35 30 17	1"	100PCS

U-TYPE HOOK

- ▶ Material: Carbon steel
- ▶ Finish: Zinc-plated



Item no.	Size	Qty / polybag
63 35 99 01	M6X42X29X20	50PCS
63 35 99 02	M8X61X44X30	50PCS
63 35 99 03	M10X85X59X40	50PCS

EYE SLIP HOOK



Item no.	Size	Qty / polybag
63 35 40 01	0.25	50PCS
63 35 40 02	0.375	50PCS
63 35 40 03	0.5	25PCS
63 35 40 04	0.625	

EYE SLIP HOOK WITH LATCHES



Item no.	Size	Qty / polybag
63 35 40 05	8	
63 35 40 06	10	
63 35 40 07	12	
63 35 40 08	14	

CLEVIS SLIP HOOK



Item no.	Size	Qty / polybag
63 35 40 09	0.25	
63 35 40 10	0.3125	
63 35 40 11	0.375	
63 35 40 12	0.5	



SECURITY PROFILE CYLINDER LOCK

- ▶ Brass, with 5 plastic covered keys



Item no.	Contents
63 30 20 01	60mm

SECURITY PROFILE CYLINDER LOCK

- ▶ Brass, with 3 keys



Item no.	Contents
63 30 20 02	60mm

SECURITY PROFILE CYLINDER LOCK

- ▶ Brass, with 3 keys



Item no.	Contents
63 30 20 03	60mm

HEAVY DUTY BRASS PADLOCK

- ▶ Heavy duty brass construction
- ▶ Fully polished surface
- ▶ Hardened steel shackle
- ▶ Brass solid cylinder
- ▶ 3 brass keys



Item no.	Contents
63 20 00 10	20mm-75mm

ARMoured CASING STAINLESS RECTANGULAR BRASS PADLOCK

- ▶ Keyed alike
- ▶ Hardened steel armoured cover and rotating shackle prevents cutting with any type of saw
- ▶ Anti-drill cylinder with ball bearing locking mechanism
- ▶ With 3 keys



Item no.	Contents
63 20 00 01	60MM
63 20 00 02	70MM
63 20 00 03	80MM
63 20 00 04	90MM

PADLOCK ARC SHAPE

- ▶ Stainless steel
- ▶ Hardened shackle
- ▶ Sliding card packing



Item no.	Contents
63 20 00 05	40MM
63 20 00 06	50MM

COMBINATION PADLOCK

- ▶ Steel casing with black or bright colored dial plate
- ▶ Features 3 number locking mechanism
- ▶ Hardened and chrome plated steel shackle



Item no.	Contents
63 20 00 07	40MM
63 20 00 08	45MM
63 20 00 09	50MM

HEAVY DUTY IRON PADLOCK

- ▶ Cast Iron material
- ▶ Grey painting
- ▶ Hardened steel shackle
- ▶ Brass lock cylinder
- ▶ 3 steel keys



Item no.	Contents
63 20 00 11	20mm-75mm

IRON PADLOCK

- ▶ Cast iron material
- ▶ Chrome plated surface
- ▶ hardened steel shackle
- ▶ Zinc alloy lock cylinder
- ▶ 4 steel keys



Item no.	Contents
63 20 00 12	40mm
63 20 00 13	50mm
63 20 00 14	60mm

LONG BRASS PADLOCK

- ▶ Brass material
- ▶ Fully polished surface
- ▶ Brass lock cylinder
- ▶ Hardened steel shackle
- ▶ 3 brass keys



Item no.	Contents
63 20 00 15	25mm-50mm

LAMINATED PACLOCK

- ▶ Hardened steel
- ▶ Zinc plated
- ▶ Brass lock cylinder
- ▶ Hardened steel shackle
- ▶ 2 steel keys



Item no.	Contents
63 20 00 16	30mm
63 20 00 17	40mm
63 20 00 18	50mm
63 20 00 19	60mm

WATER PROOF LAMINATED PADLOCK

- ▶ Hardened steel
- ▶ Zinc plated
- ▶ Brass lock cylinder
- ▶ Hardened steel shackle
- ▶ Plastic & rubber coating
- ▶ 2 steel keys



Item no.	Contents
63 20 00 20	30mm
63 20 00 21	40mm
63 20 00 22	50mm

LONG SHACKLE LAMINATED PADLOCK

- ▶ Hardened steel
- ▶ Zinc plated
- ▶ Brass lock cylinder
- ▶ Hardened steel shackle
- ▶ Plastic bottom
- ▶ 2 steel keys



Item no.	Contents
63 20 00 23	30mm-50mm

3PCS BRASS PADLOCK SET

- ▶ Brass material
- ▶ With 3 key per pad lock
- ▶ Skin card



Item no.	Contents
63 20 00 32	25/30/40mm

4PCS BRASS PADLOCK SET

- ▶ Brass material
- ▶ With 3 key per pad lock
- ▶ Skin card



Item no.	Contents
63 20 00 33	25/30/40/60mm

3PCS PADLOCK SET

- ▶ Hardened steel
- ▶ Brass lock cylinder
- ▶ Hardened steel shackle
- ▶ 4 steel keys



Item no.	Contents
63 20 00 34	30/40/50mm

COMBINATION PADLOCK

- ▶ Stainless steel material



Item no.	Contents
63 20 00 24	30/40/50mm

COMBINATION PADLOCK

- ▶ Brass steel material



Item no.	Contents
63 20 00 25	30/40/50mm

SHACKLE LOCK

- ▶ Steel material with plastic cover



Item no.	Contents
63 20 00 27	170X245mm
63 20 00 28	170X300MM

LONG TYPE SHACKLE LOCK

- ▶ Steel material with plastic cover



Item no.	Contents
63 20 00 29	130X210MM
63 20 00 30	180X245MM
63 20 00 31	180X320MM

SHACKLE LOCK

- ▶ Steel material with plastic cover



Item no.	Contents
63 40 00 01	170X245MM
63 40 00 02	170X300MM

NOTEBOOK SECURITY LOCK



Item no.	Contents
63 40 00 03	Dia. 4mmx120cm

MOTOR CYCLE BRAKE SHOE LOCK



Item no.	Contents
63 40 00 04	5.5X55MM
63 40 00 05	5.5X75MM
63 40 00 06	10X100MM



COBRA CABLE LOCK

- ▶ Flexible with strong protective PVC insulation.
- ▶ Double blister



Item no.	Contents
63 40 00 07	3x120 cm

CLOSING AVIATION CABLE LOCK

- ▶ Aviation wire cable with PVC insulation



Item no.	Contents
63 40 00 13	8x65 MM
63 40 00 14	8x80 MM

CHAIN LOCK

- ▶ Steel chain material
- ▶ With PVC coating
- ▶ With 2 keys



Item no.	Contents
63 40 00 20	Φ6×90cm

SPIRAL BICYCLE LOCK

- ▶ Spiral cable
- ▶ Polybag with head



Item no.	Contents
63 40 00 08	8x120 cm
63 40 00 09	8x180 cm

STEEL CABLE LOCK



Item no.	Contents
63 40 00 15	Φ18×65cm
63 40 00 16	Φ18×80cm
63 40 00 17	Φ18×100cm

CHAIN LOCK WITH LAMINATED PADLOCK

- ▶ Steel chain material with hardened steel material
- ▶ With PVC coating
- ▶ With 2 keys



Item no.	Contents
63 40 00 21	Φ6×90cm

SPIRAL LOCK

- ▶ Spiral cable
- ▶ Polybag with head



Item no.	Contents
63 40 00 10	12x120 cm
63 40 00 11	12x150 cm
63 40 00 12	12x180 cm

BICYCLE LOCK

- ▶ Steel sheet material
- ▶ Black painting



Item no.	Contents
63 40 00 18	

AUTOMOBILE THEFT-PROOF LOCK



Item no.	Contents
63 40 00 22	

BICYCLE LOCK



Item no.	Contents
63 40 00 19	

AUTOMOBILE THEFT-PROOF LOCK



Item no.	Contents
63 40 00 23	



DISC PADLOCK

- ▶ Fits most storefront gate
- ▶ Stainless steel armor outer shell
- ▶ Weatherproof Rustproof Waterproof



Item no. Contents

63 30 00 01	50mm
63 30 00 02	60mm
63 30 00 03	70mm
63 30 00 04	80mm
63 30 00 05	90mm

PASSAGE LOCK BODY

- ▶ With a security square bar
- ▶ Forend in round corner or square corner
- ▶ Finish: brass plated, Nickel plated, stainless steel

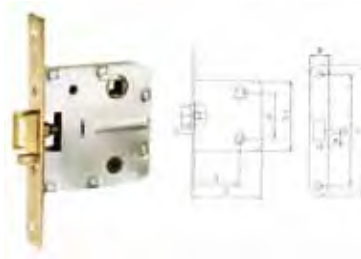

Item no. Contents

63 30 20 04	
-------------	--

DEADBOLT LOCK BODY

- ▶ Steel nickel plated 4 rods deadbolt with 3 turns
- ▶ Anti-saw function deadbolt available
- ▶ Backset: 50mm
- ▶ Finish: Brass plated, Nickel plated

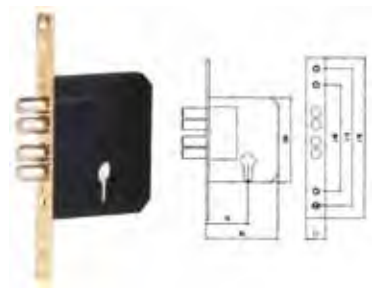

Item no. Contents

63 30 20 07	
-------------	--

BOX LOCK



Item no. Contents

63 30 60 01	
-------------	--

PASSAGE LOCK BODY

- ▶ Forend: Stainless steel
- ▶ Round corner or square corner
- ▶ Zamak latch with anti-theft function



Item no. Contents

63 30 20 05	
-------------	--

ITALIAN LOCK BODY

- ▶ Latch operated by handle or cylinder, deadbolt operated by cylinder
- ▶ Backset: 40mm



Item no. Contents

63 30 20 08	
-------------	--

DRAWER LOCK



Item no. Contents

63 30 60 01	
-------------	--

ALUMINUM LOCK BODY

- ▶ With 54mm oval cylinder with 3 keys
- ▶ Laminated swing deadbolt
- ▶ Forend covered with a decoration aluminum plate
- ▶ Backset: 23mm



Item no. Contents

63 30 20 06	
-------------	--

ITALIAN LOCK BODY

- ▶ Forend: in steel brass plated, nickel plated, brass, stainless steel
- ▶ Hook bolt operated by either handle or key and deadbolt operated by cylinder
- ▶ Backset: 40mm, 45mm

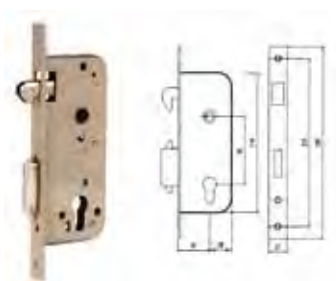

Item no. Contents

63 30 20 09	
-------------	--



FRENCH LOCK BODY

- ▶ Forend: in steel brass plated, nickel plated, brass, stainless steel
- ▶ Round corner or square corner
- ▶ Backset: 45mm



Item no.	Contents
63 30 20 10	

DOOR CLOSER

- ▶ Capacity:14-45 KGS
- ▶ Main body is fixed on the door, Active stand on the door frame
- ▶ Door's close speed is adjustable by two screws
- ▶ Door can open and close between 180 degree



Item no.	Contents
63 20 40 01	

DOOR WEDGES

- ▶ Made of PP plastic



Item no.	Contents
63 20 40 02	

12PCS DOOR WEDGES AND STOPPER SET

- ▶ Made of PP plastic



Item no.	Contents
63 90 00 01	6pcs plastic floor stop, made of PP plastic 6pcs spring floor stop, made of carbon steel, Available length of the spring: 77mm

DOOR STOPPER

- ▶ Column shape, stainless steel, fully polished surface
- ▶ 9mm diameter rubber O-ring, black rubber bottom pad



Item no.	Contents
63 20 40 10	Ø95x38mm

DOOR VIEWER

- ▶ Brass material
- ▶ Viewer diameter: 14mm
- ▶ Available thickness: 35-50mm



Item no.	Contents
63 20 40 03	14mm

DOOR VIEWER

- ▶ Brass material
- ▶ Viewer diameter: 12mm
- ▶ Available thickness: 25-38mm



Item no.	Contents
63 20 40 04	12mm

DOOR STOPPER

- ▶ Zinc alloyed material



Item no.	Contents
63 20 40 05	

DOOR HANDLE

- ▶ Stainless steel with satin finish



Item no.	Contents
63 20 40 06	

DOOR HANDLE

- ▶ Stainless steel with satin finish



Item no.	Contents
63 20 40 07	

DOOR GUARD

- ▶ Zinc alloyed material
- ▶ With brass plated



Item no.	Contents
63 20 40 08	

DOOR CHAIN

- ▶ Zinc alloyed material
- ▶ With satin finish



Item no.	Contents
63 20 40 09	

DOOR BOLT

- ▶ Brass material
- ▶ Width: 20mm



Item no.	Contents
63 26 00 01	6"
63 26 00 02	8"
63 26 00 03	10"
63 26 00 04	12"

GEMEL

- ▶ Hydraulic pressure structure
- ▶ Brass material with nickel plated



Item no.	Contents
63 24 00 01	

GEMEL

- ▶ Brass material with nickel plated

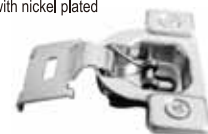

Item no.	Contents
63 24 00 02	

HANG WHEEL & DRAWER SLIDE

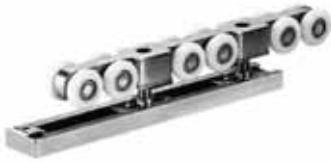

Item no.	Contents
63 99 00 03	50mm

SHELF BRACKET

- ▶ Pressed steel
- ▶ Paint coating



Item no.	Contents
63 99 00 04	100X75MM
63 99 00 05	100X125
63 99 00 06	125X150
63 99 00 07	150X200
63 99 00 08	200X250
63 99 00 09	250X300
63 99 00 10	300X350
63 99 00 11	350X400

SHELF BRACKET

- ▶ Pressed steel
- ▶ Paint coating



Item no.	Contents
63 99 00 12	295X210MM
63 99 00 13	395X270MM
63 99 00 14	495X330MM
63 99 00 15	16"X18"

LONG SHELF BRACKET

- ▶ Pressed steel
- ▶ Paint coating



Item no.	Contents
63 99 00 16	1.0 M
63 99 00 17	1.5 M
63 99 00 18	2 M

SHELF BRACKET

- ▶ Pressed steel
- ▶ Paint coating



Item no.	Contents
63 99 00 19	20CM
63 99 00 20	25CM
63 99 00 21	30CM

STAINLESS DOOR HINGES

- ▶ Satin finish



Item no.	Contents
63 24 00 04	

HOOK

- ▶ Zinc alloyed material
- ▶ Finish: brass plated/nickel plated/chrome plated
- ▶ Width: 32mm Height: 76mm



Item no.	Contents
63 99 00 22	

HOOK

- ▶ Zinc alloyed material
- ▶ Finish: brass plated/nickel plated/chrome plated



Item no.	Contents
63 99 00 23	

HOOK

- ▶ Brass material
- ▶ Finish: brass plated/nickel plated/chrome plated



Item no.	Contents
63 99 00 24	



DOUBLE HOOK

- ▶ Zinc alloy steel, chrome plated
- ▶ With 2pcs tapping screws



Item no.	Contents
63 99 00 27	

DOUBLE HOOK

- ▶ Zinc alloy steel, white finish
- ▶ With 2pcs 3*16mm tapping screws
- ▶ Size:18*46mm



Item no.	Contents
63 99 00 30	

DOUBLE HOOK

- ▶ Zinc alloy steel, gold color
- ▶ With 2pcs tapping screws



Item no.	Contents
63 99 00 33	

SINGLE HOOK

- ▶ Zinc alloy steel, chrome plated
- ▶ With 2pcs 3*16mm tapping screws
- ▶ Size:18*36mm



Item no.	Contents
63 99 00 28	

SINGLE HOOK

- ▶ Zinc alloy steel, white finish
- ▶ With 2pcs 3*16mm tapping screws
- ▶ Size:18*36mm



Item no.	Contents
63 99 00 31	

DOUBLE HOOK

- ▶ Zinc alloy steel, matt black
- ▶ With 2pcs tapping screws



Item no.	Contents
63 99 00 34	

SINGLE HOOK

- ▶ Zinc alloy steel, white finish
- ▶ With 2pcs 3*16mm tapping screws
- ▶ Size:18*36mm



Item no.	Contents
63 99 00 29	

DOUBLE HOOK

- ▶ Zinc alloy steel, white finish
- ▶ With 2pcs tapping screws



Item no.	Contents
63 99 00 32	

DOUBLE HOOK

- ▶ Zinc alloy steel, gold color
- ▶ With 2pcs tapping screws



Item no.	Contents
63 99 00 35	

LATCH(SMALL)

- ▶ Zinc alloy body,iron bar
- ▶ Body size:100*30mm
- ▶ Bar size:13.5*3mm
- ▶ With 7pcs 3*13mm tapping screws
- ▶ Size:100mm



Item no.	Contents
63 99 00 36	

NUMBER MARK

- ▶ Zinc alloyed/Brass material



Item no.	Contents
63 99 00 25	

LATCH

- ▶ Zinc alloy body,chrome plated
- ▶ Body size:97*33mm
- ▶ With 6pcs 3*13mm tapping screws
- ▶ Size:80mm



Item no.	Contents
63 99 00 37	

MARK BOARD

- ▶ Stainless steel material



Item no.	Contents
63 99 00 26	



HOUSEHOLD WARE

DRAIN CLEANER

- ▶ Fully flexible plated spring steel
- ▶ With plastic handle
- ▶ Shrunk foil packing



Item no.	Contents
65 50 20 01	Φ5.5x3m
65 50 20 02	Φ9x5m
65 50 20 03	Φ9x10m

WIRE DRAIN CLEANER

- ▶ Economically priced manual unit for learing blocked sinks or drains
- ▶ Featuring 1.5mmx6mmx5m in snake with a basin plug head, for entry through sink waste strainers



Item no.	Contents
65 50 20 04	

TOILET PUMP

- ▶ Material: PP+PVC



Item no.	Contents
65 50 20 05	

VACUUM PUMP, WITH BIG HEAD

- ▶ PVC body with PP handle



Item no.	Contents
65 50 20 06	

VACUUM PUMP, WITH SMALL HEAD

- ▶ PVC body with PP handle



Item no.	Contents
65 50 20 07	

TOILET PUMP

- ▶ Material:PVC



Item no.	Contents
65 50 20 08	

POWER PLUNGER

- ▶ Ideal for sink, baths and toilets.
- ▶ Includes 4 different attachments



Item no.	Contents
65 50 20 09	

PVA MOP

- ▶ Aluminium tube,metal lift handle,3 sections



Item no.	Contents
65 50 00 01	

FLAT MOP

- ▶ Metallic tube



Item no.	Contents
65 50 00 02	120cm

TAPE DISPENSER

- ▶ With stopper and tape cutter Suitable for 50.8mm adhesive tapes.
- ▶ Including one roll of adhesive tape.Color box packing



Item no.	Contents
65 50 50 01	

PLASTICS WITH HORSEHAIR FIBER BRUSH



Item no.	Contents
35 40 00 01	

75PCS NYLON TIE CABLE SET

- ▶ 25 piece 100mm, 25 piece 120mm, 25 piece 200mm in polybag with head card



Item no. Contents

65 50 40 01

TWIST TIE

- ▶ Strong, flexible, multi-use ties for home and garden with cutter



Item no. Contents

65 50 40 02 20 m

65 50 40 03 30 m

65 50 40 04 100 m

WIRE TIE

- ▶ Zinc-plated iron wire, strong and flexible



Item no. Contents

65 50 40 05 50 m

HOOK



Item no. Contents

65 50 70 01 150 m

65 50 70 02 200 m

HOOK



Item no. Contents

65 50 70 03 150 m

65 50 70 04 200 m

MAGNIFIER

- ▶ With lighter, without batteries



Item no. Contents

65 40 20 01 66mm

65 40 20 02 80mm

MAGNIFIER



Item no. Contents

65 40 20 03

HELPING HAND MAGNIFIER

- ▶ Acrylic bifocal lens, Two different magnification on one lens, high definition
- ▶ 2 pieces of white LED light with high brightness
- ▶ Use 3 pieces of 5VAAA battery
- ▶ Adjustable height and angle of both magnify lens and clips added more convenience of control and operation
- ▶ Cast iron stand and new design iron holder give you incomparable operating experience



Item no. Contents

65 40 20 20

HELPING HAND MAGNIFIER

- ▶ 5x65
- ▶ Size: 52x405x155cm
- ▶ 21kgs/19kgs



Item no. Contents

65 40 20 21

HANDHELD ILLUMINATED MAGNIFIER

- ▶ 3x75/8x20
- ▶ Size: 53x41x30cm
- ▶ Volume: 120pcs
- ▶ 15/13kgs



Item no. Contents

65 40 20 22

HANDHELD ILLUMINATED MAGNIFIER

- ▶ 5X75
- ▶ Size: 55X34X45cm
- ▶ Volume: 180pcs
- ▶ 23/21kgs



Item no. Contents

65 40 20 23

HANDHELD ILLUMINATED MAGNIFIER

- ▶ 3x60
- ▶ Size: 33x22x11cm
- ▶ Volume: 120PCS
- ▶ 18KGS/16KGS



Item no. Contents

65 40 20 24

HANDHELD ILLUMINATED MAGNIFIER

- ▶ 5x75
- ▶ 300pcs
- ▶ 55.5x42x33.5cm
- ▶ 27/25kgs



Item no. Contents

65 40 20 25



MOVABLE HANDLE MAGNIFIER

- ▶ 15X30
- ▶ 400pcs/ctn
- ▶ 36.5x22.5x39cm



Item no. Contents

65 40 20 26

MOVABLE HANDLE MAGNIFIER

- ▶ 20X30
- ▶ 480pcs/ctn
- ▶ 36.5x22.5x39cm



Item no. Contents

65 40 20 27

MOVABLE HANDLE MAGNIFIER

- ▶ 6X60
- ▶ 400pcs/ctn
- ▶ 45x40x25.5cm



Item no. Contents

65 40 20 28

CLOTH-ILLUMINATING MAGNIFIER

- ▶ 10X16



Item no. Contents

65 40 20 29

BINOCULAR

- ▶ Binocular
- ▶ Magnification: 8x
- ▶ Object lens diameter: 21mm
- ▶ Angle of view: 131m/1000m
- ▶ Exit pupil diameter: 2.7mm
- ▶ Exit pupil distance: 10mm
- ▶ Size: 90x100x35mm



Item no. Contents

65 40 20 30

BINOCULAR

- ▶ Magnification: 8x
- ▶ Object lens diameter: 32mm
- ▶ Angle of view: 301 ft/1000ft
- ▶ Exit pupil diameter: 4mm
- ▶ Exit pupil distance: 5mm
- ▶ Weight: 335g



Item no. Contents

65 40 20 31

5PCS PTFE TAPE SET

- ▶ 12mmx12mmx0.075mm



Item no. Contents

80 10 20 01

COMPASS



Item no. Contents

65 60 60 01

ASTRONOMICAL TELESCOPE

- ▶ 1) Interchangeable 50X and 100X eyepiece lenses
- ▶ 2) Objective diameter: 50mm
- ▶ 3) Focal Length: 600mm
- ▶ 4) 3X finder scope to locate objects faster
- ▶ 5) Lightweight durable aluminum construction
- ▶ 6) Full-sized adjustable tripod
- ▶ 7) Mirrored diagonal eyepiece for easy viewing
- ▶ 8) Quick screw-type assembly with no tools required
- ▶ 9) Great for star tracking & astronomical viewing
- ▶ 10) Color: Silver
- ▶ 11) Net weight: 930g
- ▶ 12) Size: 73x22x8.7cm



Item no. Contents

65 60 00 01

TELESCOPE

- ▶ 1) Magnification: 8
- ▶ 2) Objective diameter: 21mm
- ▶ 3) Exit pupil diameter: 2.6mm
- ▶ 4) Field of view (1,000m): 131m
- ▶ 5) Prism system: Roof
- ▶ 6) Prism class: Bak7
- ▶ 7) Coating: Blue coated
- ▶ 8) Materials: Metal and rubber
- ▶ 9) Color: Black
- ▶ 10) Net weight: 85g
- ▶ 11) Size: 8.8x3.1cm



Item no. Contents

65 60 00 02

WOODEN MOUSE TRAPS



Item no. Contents

65 50 60 01

100x45

65 50 60 02

180x85

IRON MOUSE TRAPS



Item no. Contents

65 50 60 03

175x95

RETRACTABLE DRYER

- ▶ Extends to 8'4"(2.5m)
- ▶ 10m(33.2') length of total drying area



Item no.	Contents
65 99 00 01	

FOLDABLE TABLE

- ▶ Solid, multi-function foldable table
- ▶ For household, garden etc.
- ▶ Adjustable height
- ▶ Easy-to-clean surface



Item no.	Contents
65 60 40 01	1MX0.58M

STEP LADDER

- ▶ Step size:1002X582X28.5MM
- ▶ Tube size:20X15MM
- ▶ Adjustable height: 540-628-695-750-795MM.



Item no.	Contents
55 50 40 01	

ALUMINUM DUAL-PURPOSE FOLDING LADDER



Item no.	Contents
55 50 40 02	

LADDER



Item no.	Contents
55 50 40 03	640X440X445MM

VACUUM FLASK

- ▶ stainless steel



Item no.	Contents
65 60 60 02	0.5L 68x240mm
65 60 60 03	1L 83x298mm

CLOCKMAKER'S TOOL SET

- ▶ Changing watch straps or bracelets
- ▶ Changing watch-batteries
- ▶ Minor repair work
- ▶ In Alu-case with window



Item no.	Contents
65 40 20 04	

POLYTHENE TARPULINS

- ▶ 100% water proof
- ▶ With strong nickelplated eyes
- ▶ Rim protection by welded-in reinforcing cord



Item no.	Contents
65 60 60 04	2x3M
65 60 60 05	3x4M
65 60 60 06	4x5M

7PCS OUTDOOR&TRAVELLER SET



Item no.	Contents
65 90 00 01	750 ML VACUUM FLASK, STAINLESS STEEL, (ACC. TO BS EN 12546-1:2000) 15-IN-1 MULTI TOOL 4x30 MM BINOCULAR COMPASS LED-FLASHLIGHT (AAA-BATTERY NOT INCLUDED) WHISTLE CARRYING BAG

5PCS KITCHEN TOOL SET

- ▶ Made of zinc alloy
- ▶ Include:corkscrew, bottle opener, can opener, nutcracker,garlic press
- ▶ With wooden base



Item no.	Contents
65 90 00 02	

32PCS SET OF LININGS FOR FURNITURE

- ▶ The linings for furniture
- ▶ material felt.

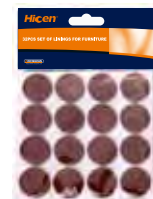

Item no.	Contents
65 90 00 03	round (diameter 22 mm) 16 pcs squared 22*22mm 16 pcs

131PCS SET OF LININGS FOR FURNITURE

- ▶ The linings for furniture



Item no.	Contents
65 90 00 04	36 pcs round 15x2mm 48 pcs round 20x2mm 1 pcs square 200x200x2mm 36 pcs round 10x1mm 10 pcs 38x4mm



HAND RIVETER

- ▶ GS-approval
- ▶ Aluminum body with 4 nozzles 2.4, 3.2, 4.0 and 4.8mm
- ▶ Supplied with nozzle wrench.



Item no.	Contents
70 20 00 01	260mm

HAND RIVETER

- ▶ Carbon Steel with 4 nozzles 2.4, 3.2, 4.0 and 4.8mm
- ▶ PVC handle
- ▶ Supplied with nozzle wrench



Item no.	Contents
70 20 00 02	260mm

HAND RIVETER

- ▶ Professional, GS-approval
- ▶ Aluminum body with 4 nozzles 2.4, 3.2, 4.0 and 4.8mm
- ▶ Supplied with nozzle wrench



Item no.	Contents
70 20 00 03	265mm

HAND RIVETER

- ▶ Aluminum body with 4 nozzles 2.4, 3.2, 4.0 and 4.8mm
- ▶ PVC handle
- ▶ Supplied with nozzle wrench.



Item no.	Contents
70 20 00 04	240mm(9.5")

HAND RIVETER

- ▶ Professional
- ▶ Aluminum body with 4 nozzles 2.4, 3.2, 4.0 and 4.8mm
- ▶ Supplied with nozzle wrench



Item no.	Contents
70 20 00 05	265mm

HAND RIVETER

- ▶ 360° rotatory head
- ▶ Aluminum body with 4 nozzles 2.4, 3.2, 4.0 and 4.8mm
- ▶ Supplied with nozzle wrench



Item no.	Contents
70 20 00 06	10.5"

HAND RIVETER

- ▶ Hardened steel body with 4 nozzles 2.4, 3.2, 4.0 and 4.8mm
- ▶ Supplied nozzle wrench



Item no.	Contents
70 20 00 07	

HAND RIVETER KIT

- ▶ Hardened steel body with 4 nozzles 2.4, 3.2, 4.0 and 4.8mm
- ▶ With 60 rivets & nozzle wrench
- ▶ Packing: plastic case



Item no.	Contents
70 20 00 08	250mm

HAND RIVETER

- ▶ Professional GS-approval
- ▶ Hardened steel chrome-plated body
- ▶ With 4 nozzles 2.4, 3.2, 4.0 and 4.8mm
- ▶ Supplied with nozzle wrench



Item no.	Contents
70 20 00 09	250mm

HAND RIVETER

- ▶ Professional GS-approval
- ▶ Hardened steel chrome-plated body
- ▶ With 4 nozzles 2.4, 3.2, 4.0 and 4.8mm
- ▶ Supplied with nozzle wrench



Item no.	Contents
70 20 00 10	260mm(10.5")

HAND RIVETER

- ▶ Professional GS-approval
- ▶ 360° rotatory head
- ▶ Aluminum body 4 nozzles to accept 2.4, 3.2, 4.0 and 4.8mm
- ▶ Supplied with nozzle wrench



Item no.	Contents
70 20 00 11	290mm

HAND RIVETER

- ▶ Aluminum body with 4 nozzles 2.4, 3.2, 4.0 and 4.8mm
- ▶ Steel tubular handle with PVC grips
- ▶ Supplied with nozzle wrench.



Item no.	Contents
70 20 00 12	17 /430mm

LEVEL RIVETER

- ▶ Aluminum body with 4 nozzles 6.4,4.8,4.0 and 3.2mm
- ▶ Steel tubular handle with PVC grips
- ▶ Supplied with nozzle wrench.



Item no.	Contents
70 20 00 13	505mm(20")

LABORSAVING LEVEL RIVETER

- ▶ Total length 280 mm
- ▶ Aluminum body with 4 nozzles 2.4, 3.2, 4.0 and 4.8mm
- ▶ Used for stainless rivet 2.4~4.8 mm 3/32"~3/16"
- ▶ Steel tubular handle with grips
- ▶ With bottle for cutted rivets collected
- ▶ Supplied with nozzle wrench.



Item no.	Contents
70 20 00 14	

LAZY TONG RIVETER

- ▶ Aluminum body with 4 nozzles 2.4, 3.2, 4.0 and 4.8mm



Item no.	Contents
70 20 00 15	800mm(32")

LAZY TONG RIVETER

- ▶ Aluminum body with 4 nozzles 2.4, 3.2, 4.0 and 4.8mm



Item no.	Contents
70 20 00 16	800mm(32")

LAZY TONG RIVETER

- ▶ Aluminum body with 4 nozzles 2.4, 3.2, 4.0 and 4.8mm



Item no.	Contents
70 20 00 17	800mm(32")

HAND RIVETER

- ▶ Aluminum main body, carbon steel handles with PVC cover
- ▶ Suitable for nuts: M3, M4, M5, M6
- ▶ Outer sleeve adjustable working stroke
- ▶ Max working stroke: 7mm
- ▶ Ergonomic grip for easy operation
- ▶ Shock-proof design to eliminate vibration of the operation of the arm
- ▶ Length: 200mm



Item no.	Contents
70 20 00 18	

LEVEL RIVETER

- ▶ Aluminum main body, carbon steel handles with PVC cover
- ▶ Suitable for nuts: M3, M4, M5, M6, M8, M10, M12
- ▶ Outer sleeve adjustable working stroke
- ▶ Max working stroke: 9mm
- ▶ Ergonomic grip for easy operation
- ▶ Shock-proof design to eliminate vibration of the operation of the arm
- ▶ The thickness of handles: 3mm
- ▶ Length: 440mm



Item no.	Contents
70 20 00 19	

LEVEL RIVETER

- ▶ Aluminum main body, carbon steel handles with PVC cover
- ▶ Suitable for nuts: M3, M4, M5, M6, M8, M10, M12
- ▶ Outer sleeve adjustable working stroke
- ▶ Max working stroke: 9mm
- ▶ Ergonomic grip for easy operation
- ▶ Shock-proof design to eliminate vibration of the operation of the arm
- ▶ The thickness of handles: 2.5mm
- ▶ Length: 330mm



Item no.	Contents
70 20 00 20	



LEVEL RIVETER

- ▶ Aluminum main body, carbon steel handles with PVC cover
- ▶ Suitable for nuts: M3, M4, M5, M6, M8, M10, M12
- ▶ Outer sleeve adjustable working stroke
- ▶ Max working stroke: 9mm
- ▶ Ergonomic grip for easy operation
- ▶ Shock-proof design to eliminate vibration of the operation of the arm
- ▶ The thickness of handles: 3mm
- ▶ Length: 440mm



Item no.	Contents
70 20 00 21	

LEVEL RIVETER

- ▶ Aluminum main body, carbon steel handles with PVC cover
- ▶ Bottle collects snapped rivets to protect people and environment
- ▶ Outer sleeve adjustable working stroke
- ▶ Max working stroke: 9mm
- ▶ Ergonomic grip for easy operation
- ▶ Shock-proof design to eliminate vibration of the operation of the arm
- ▶ The thickness of handles: 3mm
- ▶ Maximum size of rivets: 6.4mm
- ▶ Length: 310mm



Item no.	Contents
70 20 00 22	

LEVEL RIVETER

- ▶ Aluminum main body, carbon steel handles with PVC cover
- ▶ Bottle collects snapped rivets to protect people and environment
- ▶ Outer sleeve adjustable working stroke
- ▶ Max working stroke: 9mm
- ▶ Ergonomic grip for easy operation
- ▶ Shock-proof design to eliminate vibration of the operation of the arm
- ▶ The thickness of handles: 3mm
- ▶ Maximum size of rivets: 6.4mm
- ▶ Length: 380mm



Item no.	Contents
70 20 00 23	

LEVEL RIVETER

- ▶ Aluminum main body, carbon steel handles with PVC cover
- ▶ Bottle collects snapped rivets to protect people and environment
- ▶ Outer sleeve adjustable working stroke
- ▶ Max working stroke: 9mm
- ▶ Ergonomic grip for easy operation
- ▶ Shock-proof design to eliminate vibration of the operation of the arm
- ▶ The thickness of handles: 3mm
- ▶ Maximum size of rivets: 6.4mm
- ▶ Length: 300mm



Item no.	Contents
70 20 00 24	

LEVEL RIVETER

- ▶ Aluminum main body, carbon steel handles with PVC cover
- ▶ Outer sleeve adjustable working stroke
- ▶ Max working stroke: 9mm
- ▶ Ergonomic grip for easy operation
- ▶ Shock-proof design to eliminate vibration of the operation of the arm
- ▶ The thickness of handles: 1.5mm
- ▶ Maximum size of rivets: 6.4mm
- ▶ Length: 300mm



Item no. Contents

70 20 00 25

LEVEL RIVETER

- ▶ Aluminum main body, carbon steel handles with PVC cover
- ▶ Bottle collects snapped rivets to protect people and environment
- ▶ Outer sleeve adjustable working stroke
- ▶ Max working stroke: 9mm
- ▶ Ergonomic grip for easy operation
- ▶ Supplied with nozzle wrench
- ▶ Shock-proof design to eliminate vibration of the operation of the arm
- ▶ The thickness of handles: 2.5mm
- ▶ Maximum size of rivets: 6.4mm
- ▶ Length: 320mm



Item no. Contents

70 20 00 26

HAND RIVETER

- ▶ Aluminum main body, carbon steel handles with PVC cover
- ▶ Outer sleeve adjustable working stroke
- ▶ Max working stroke 7 mm
- ▶ Ergonomic grip for easy operation
- ▶ Shock-proof design to eliminate vibration of the operation of the arm
- ▶ With 4 nozzles: 2.4, 3.2, 4.0, 4.8mm
- ▶ Length: 200mm



Item no. Contents

70 20 00 27

ANCHOR RIVETER

- ▶ Aluminum body
- ▶ PVC Handle



Item no. Contents

70 20 20 01

5"

ANCHOR RIVETER

- ▶ Aluminum body
- ▶ PVC Handle



Item no. Contents

70 20 20 02

5"

ANCHOR RIVETER

- ▶ Carbon steel
- ▶ PVC handle



Item no. Contents

70 20 20 03

4.5"

ANCHOR RIVETER

- ▶ Carbon steel
- ▶ PVC handle



Item no. Contents

70 20 20 04

10"

188 PCS ANCHOR RIVETER



Item no. Contents

70 90 00 01

1 pc anchor riveter
187pc anchor: 30 pcs. M4x25;
25 pcs. M4x39; 25 pcs. M4x45
22 pcs. M4x52; 45 pcs. M5x45;
15 pcs. M5x58; 25 pcs. M5x71

CAULKING GUN

- ▶ Pressed steel
- ▶ gear pushing bar



Item no. Contents

70 30 00 01

9" / 225mm

CAULKING GUN

- ▶ Pressed steel
- ▶ gear pushing bar



Item no. Contents

70 30 00 02

9" / 225mm

CAULKING GUN

- ▶ Pressed steel
- ▶ gear pushing bar



Item no. Contents

70 30 00 03

9" / 225mm

SKELETON TYPE CAULKING GUN

- ▶ Aluminum body+trigger



Item no. Contents

70 30 00 04

9" / 225mm

3-IN-1 HEAVY DUTY CAULKING GUN

- ▶ Pressed steel
- ▶ Chrome plated, serrated groove shaft
- ▶ Wrist strap in grip
- ▶ With cutter



Item no. Contents

70 30 00 05

9" / 225mm

HEAVY DUTY CAULKING GUN

- ▶ With shaft pusher
- ▶ pressed steel body
- ▶ Aluminum handle.



Item no.	Contents
70 30 00 06	9" / 225mm

PROFESSIONAL CAULKING GUN

- ▶ With shaft pusher
- ▶ Pressed steel body
- ▶ Heavy duty ABS handles.



Item no.	Contents
70 30 00 07	9" / 225mm

PROFESSIONAL CAULKING GUN

- ▶ With shaft pusher
- ▶ Aluminum tube body
- ▶ Heavy duty aluminum handles.



Item no.	Contents
70 30 00 08	9" / 225mm

CAULKING GUN

- ▶ Light aluminum casting handle
- ▶ 360 degree rotation



Item no.	Contents
70 30 00 09	10.5"

CAULKING GUN

- ▶ With double shaft pusher
- ▶ Pressed steel body
- ▶ Heavy duty aluminum handles.



Item no.	Contents
70 30 00 10	9"

FOAM GUN

- ▶ Polypropylene body
- ▶ Aluminum adaptor
- ▶ Copper Outlet Nozzle
- ▶ Stainless steel tube
- ▶ Semi-bright Nickel-plated Finish



Item no.	Contents
70 30 00 21	

FOAM GUN

- ▶ Made of brass with plastic handle
- ▶ with extra tube and nozzels



Item no.	Contents
70 30 00 22	10.5"

FOAM GUN

- ▶ Made of brass with plastic handle
- ▶ with extra tube and nozzels



Item no.	Contents
70 30 00 23	

FOAM GUN

- ▶ Aluminum body and adaptor
- ▶ Black PTFE Coating for Adaptor
- ▶ Copper steel barrel
- ▶ Semi-bright Nickel-plated finish



Item no.	Contents
70 30 00 24	

5PCS SOLDERING GUN KIT



Item no.	Contents
70 90 00 02	1pc 30W soldering iron , 230V/50Hz,GS-approved 1pc soldering stand 1pc soldering wire 1pc spare tip 1pc soldering paste

SOLDERING IRON

- ▶ GS-approval
- ▶ Straight tip
- ▶ With soldering stand
- ▶ VDE approved pin plug & cable



Item no.	Contents
70 10 00 01	25 W
70 10 00 02	30 W
70 10 00 03	40 W
70 10 00 04	60 W
70 10 00 05	80 W
70 10 00 06	100 W

SOLDERING IRON

- ▶ GS-approval
- ▶ Bent tip
- ▶ VDE approved pin plug & cable



Item no.	Contents
70 10 00 07	15/25/30/40/60/80/100W

PENCIL TORCH

- ▶ For all smaller soldering and welding works
- ▶ For glass, tin, copper, aluminium, silver and gold
- ▶ Normal lighter's gas can be filled



Item no.	Contents
70 10 10 01	



ENGRAVING SOLDERING IRON

- ▶ GS-approval
- ▶ With 7 different shape exchangeable tips
- ▶ With soldering stand
- ▶ VDE approved pin plug & cable



Item no.	Contents
70 10 00 08	30W

25 PCS ENGRAVING SOLDERING IRON



Item no.	Contents
70 90 00 03	30W

SOLDERING GUN

- ▶ GS-approval
- ▶ 230V~, 50Hz, 100W
- ▶ With soldering stand With
- ▶ VDE approval pin plug and cable



Item no.	Contents
70 10 10 02	100W

SOLDERING GUN

- ▶ GS-approval
- ▶ 230V~, 50Hz, 100W
- ▶ With soldering stand With
- ▶ VDE approval pin plug and cable



Item no.	Contents
70 10 10 03	175W

SOLDERING GUN

- ▶ GS-approval
- ▶ 230V~, 50Hz, 200W
- ▶ With soldering stand With
- ▶ VDE approval pin plug and cable



Item no.	Contents
70 10 10 04	200W

SOLDERING GUN

- ▶ GS-approval
- ▶ 230V~, 50Hz, 250W
- ▶ With soldering stand With
- ▶ VDE approval pin plug and cable



Item no.	Contents
70 10 10 05	250W

4 PCS SOLDERING GUN



Item no.	Contents
70 90 00 04	1pc AC230V,50Hz,100W soldering gun 1pc spare tip 1pc soldering wire 1pc soldering paste

5 PCS SOLDERING GUN KIT

- ▶ In blowcase



Item no.	Contents
70 90 00 05	1Pc soldering gun 100W 2pcs spare soldering tips 1pc soldering wire tin 10g 1pc soldering grease 10g

9 PCS SOLDERING GUN KIT

- ▶ GS/CE/EMC/RoHS



Item no.	Contents
70 90 00 06	1pc 220-240V~, 50Hz, 100W soldering gun 1pc 230-240V~, 50Hz, 30W soldering iron 1pc soldering tip 1pc soldering tin 1pc soldering paste 1pc hands free magnifyer 1pc Soldering sucker 1 scraper 1 iron stand

20 PCS SOLDERING IRON KIT



Item no.	Contents
70 90 00 07	1 pc container for sapre parts
	1pc IEC setting tool
	1pc IEC-extractor
	1pc earthing band with helix-cable and clamp
	2pcs socket wrench 3/16", 1/4"
	3pcs screwdriver PH:0x60,1x80,2x100
	3pcs screwdriver SL:3.5X75,5.5X100,6.5X100mm
	1pc screwdriver handle with bits T15
	1pc self-closing tweezers
	1pc tweezers
	1pc claw pick-up tool
	1pc soldering wire
	1pc 5.5 long nose pliers with round srping
	1pc soldering iron, 40W, GS-approval
	1pc leather zipper bag

SOLDER SUCKER



Item no.	Contents
70 10 60 01	

SOLDER SUCKER



Item no.	Contents
70 10 60 02	

WELDING MACHINE

- ▶ Rated Voltage: 110/240V
- ▶ No Load Voltage: 48V
- ▶ Current Rante: 45-100A
- ▶ Rated Duty: 10%
- ▶ Input Capacity: 5KVA
- ▶ Class of Insulation: H
- ▶ Usable Electrodes: 1.6-2.5mm



Item no.	Contents
70 10 20 01	

INVETER PLASMA CUTTING MACHINE

- ▶ With handle for easy carrying, fan cooling, over heat protection, non-contact arc
- ▶ Advanced IGBT inverter technology, small, light, EMC-standard
- ▶ Air plasma cutting,promise current regulator,allow fast curve cutting
- ▶ Accessories: cutting gun, earth clamp, welding cable, welding cap



Item no.	Contents
70 10 20 02	

GERMANY STYLE ELECTRODE HOLDER

- ▶ Copper core
- ▶ Bakelite
- ▶ Sheath



Item no.	Contents
70 10 30 01	300A/500A

AMERICAN STYLE ELECTRODE HOLDER

- ▶ Copper core
- ▶ Bakelite
- ▶ Sheath



Item no.	Contents
70 10 30 02	300A/500A

BRITISH-STYLE CUTTING TORCH

- ▶ Material: brass + stainless steel



Item no.	Contents
70 10 10 06	

AMERICAN-STYLE CUTTING TORCH

- ▶ Material: brass + stainless steel



Item no.	Contents
70 10 10 07	250mm

GERMANY-STYLE CUTTING TORCH

- ▶ Material: brass
- ▶ With 3 cutting nozzle
- ▶ Carbon steel wrench
- ▶ Cutting planes



Item no.	Contents
70 10 10 08	

FRENCH-STYLE WELDING TORCH

- ▶ Material: brass + stainless steel
- ▶ With 4 welding nozzle



Item no.	Contents
70 10 10 09	

FRENCH-STYLE WELDING TORCH

- ▶ Material: brass
- ▶ With 3 welding nozzle



Item no.	Contents
70 10 10 10	

HEATING TORCH

- ▶ Double switch
- ▶ Brass valve,Steel burner.
- ▶ Burn Diam. 50mm



Item no.	Contents
70 10 10 11	



CONNECTING AND WELDING TOOLS

HEATING TORCH

- ▶ Brass valve, Stainless steel burner.
- ▶ Burn Dia.40mm



Item no.	Contents
70 10 10 12	

OXYGEN DECOMPRESSION GAUGE

- ▶ Material: brass
- ▶ With 2 pressure gauges



Item no.	Contents
70 10 60 03	

ACETYLENE DECOMPRESSION GAUGE

- ▶ Material: brass
- ▶ With 2 pressure gauges



Item no.	Contents
70 10 60 04	

WELDING&CUTTING TORCH KIT

- ▶ 1 set oxygen decompression gauge
- ▶ 1 set acetylene decompression gauge
- ▶ 1 pc cutting torch
- ▶ 1pc cutting torch handle
- ▶ 1pc cutting nozzle 2-1-101
- ▶ 1pc mixer
- ▶ 1set heating nozzle and heating pipe with a mixer
- ▶ 1 set welding pipe1#;2#;3# with mixer
- ▶ 1pc cleaner
- ▶ 1pc protection goggle



Item no.	Contents
70 90 00 08	

SOLDERING TIN

- ▶ Lead/Tin wire diameter 50g
- ▶ On plastic roller



Item no.	Contents
70 10 40 01	30/70,40/60,50/50

SOLDERING PASTE

- ▶ 50g in metal box



Item no.	Contents
70 10 60 05	

SOLDERING STAND

- ▶ Casting iron base with spring holder



Item no.	Contents
70 10 60 06	

WELDING ANGLE IRON

- ▶ Multi-angle
- ▶ Magnet between steel plate.



Item no.	Contents
70 10 60 07	

SOLDERING TIN

- ▶ Tin wire diameter1.0-1.2Nmm, 17g
- ▶ In plastic tube



Item no.	Contents
70 10 40 02	17g

ELECTRODE FOR CASTING IRON/STAINLESS STEEL

- ▶ With good mechanical properties, thermal properties and resistance to intergranular corrosion .
- ▶ Available size:2.5mm ;3.0mm;4.0mm etc.



Item no.	Contents
70 10 40 03	250/300/350mm

STAINLESS STEEL WELDING WIRE/BRASS WELDING WIRE



Item no.	Contents
70 10 40 04	1.0---3.0mm

COPPER CARBON ELECTRODE

- ▶ carbon rod, copper coated



Item no.	Contents
70 10 40 05	1.0---3.0mm

THORIATED TUNGSTEN ELECTRODE

- ▶ Easy to operate
- ▶ Large current load of
- ▶ Easy arc ignition, arc stability
- ▶ Arc gap big losses small
- ▶ Long life
- ▶ higher recrystallization temperature
- ▶ Better conductivity and mechanical cutting performance



Item no.	Contents
70 10 40 06	

NOZZLE CLEANER

- ▶ Aluminum case
- ▶ 13 pcs needle, length 70mm(2-3/4"), diameter 6-26



Item no.	Contents
70 10 60 08	

FLAME IGNITOR

- ▶ Punched cap
- ▶ Chrome-plated handle



Item no.	Contents
70 10 60 09	

HOT AIR GUN

- ▶ GS/CE - Approval
- ▶ 230 Voltage adjustable power 750 W /1500 W for 300°C/ 500°C air flow: 280L/min / 480 L/Min



Item no.	Contents
70 10 50 01	750W / 1500W

HOT AIR GUN

- ▶ GS/CE - Approval
- ▶ 230 Voltage adjustable power 750 W /1500 W for 300°C/ 500°C air flow: 280L/min / 480 L/Min



Item no.	Contents
70 10 50 02	1000W / 2000W

HOT AIR GUN

- ▶ 230V~50Hz
- ▶ Rate Power I/II 1000/2000W
- ▶ Temperature I/II:350/550°C
- ▶ Air Flow I/II:300/500 l/min
- ▶ 2m VDE cable, VDE plug



Item no.	Contents
70 10 50 03	

STAPLE GUN

- ▶ General duty model with slide over stitching anvil
- ▶ Suitable for a wide Variety of DIY application
- ▶ Safety loop on the handle
- ▶ Uses 4 - 8mm staples



Item no.	Contents
70 40 00 01	4-8mm

STAPLE GUN

- ▶ Economic staple gun 4-14mm
- ▶ Material: ABS
- ▶ Staple measurement: door style 4-14mm



Item no.	Contents
70 40 00 02	4-14mm

STAPLE GUN

- ▶ Made of all steel construction
- ▶ Safety loop on the handle
- ▶ Use 4 -14mm staples



Item no.	Contents
70 40 00 03	4-14mm

STAPLE GUN

- ▶ Heavy duty model
- ▶ With adjustable power control and slide over slip on anvi
- ▶ Safety loop on the handle
- ▶ Use 4 -14mm staples



Item no.	Contents
70 40 00 04	4-14mm

3-IN-1 STAPLE GUN

- ▶ Heavy duty model
- ▶ with adjustable power control and slide over slip on anvil
- ▶ Safety loop on the handle
- ▶ Use 3 types staples and nails, size 4-14mm



Item no.	Contents
70 40 00 05	4-14mm

HEAVY DUTY STAPLE GUN

- ▶ Heavy duty steel construction
- ▶ Safety loop on the handle
- ▶ Use 4-14mm staple



Item no.	Contents
70 40 00 06	4-14mm

HEAVY DUTY STAPLE GUN

- ▶ Heavy duty steel construction
- ▶ Safety loop on the handle
- ▶ Use 4-14mm staple



Item no.	Contents
70 40 00 07	4-14mm

HEAVY DUTY STAPLE GUN

- ▶ Durable Aluminum Alloy die-casting housing construction
- ▶ The new rubber/plastic injection bi-material handle
- ▶ Use crown 4-14mm staples



Item no.	Contents
70 40 00 08	4-14mm

HEAVY DUTY HAMMER TACKER

- ▶ Durable steel housing construction
- ▶ The new rubber/plastic injection bi-material handle
- ▶ Use crown 6-14mm staples



Item no.	Contents
70 40 20 01	6-14mm

HEAVY DUTY STAPLE REMOVER



Item no.	Contents
70 40 90 01	

HEAVY DUTY 3-WAYS STAPLE GUN&REMOVER SET

- ▶ 1pc 3-way staple gun
- ▶ 1pc staple remover
- ▶ 200pcs staples



Item no.	Contents
70 90 00 11	

3-IN-1 STAPLE GUN SET

- ▶ 3-in-1 staple gun, impact pressure adjustment, handle lock. for crown staples with 4mm-14mm leng length; for U-shaped crown staples with 10mm-12mm leg length; for 10-14mm nails
- ▶ with 8mm staples; 12mm U-shaped staples, 10mm nail
- ▶ Plastic box packing.



Item no.	Contents
70 90 00 12	

ELECTRONIC STAPLE GUN

- ▶ 230v~50Hz
- ▶ For crown staples 15mm-32mm length
- ▶ For 15-32mm nails



Item no.	Contents
70 40 10 01	

HOT GLUE GUN

- ▶ 230Volt, 50 HZ, 10W(60W)
- ▶ GS-approval



Item no.	Contents
70 30 20 01	10W

HOT GLUE GUN

- ▶ 230Volt, 50 HZ,10W
- ▶ GS-approval
- ▶ Incl. 2 piece 7mmx100 mmm glue sticks; In double blister



Item no.	Contents
70 30 20 02	10W

HOT GLUE GUN

- ▶ 230Volt, 50 HZ,10W
- ▶ GS-approval
- ▶ Incl. 2 piece 7mmx100 mmm glue sticks; In double blister



Item no.	Contents
70 30 20 03	40W

HOT GLUE GUN

- ▶ 230Volt, 50 HZ, 25W / 78W
- ▶ Incl. 2 piece Φ11mmx100 mm glue sticks; In double blister



Item no.	Contents
70 30 20 04	25W/78W

CORDLESS HOT GLUE GUN

- ▶ CE GS EMC approval
- ▶ 230Volt, 50 HZ, 23W(60W)
- ▶ Incl. 2 piece Φ11mmx100 mm glue sticks



Item no.	Contents
70 30 20 05	23(60)W

HOT GLUE GUN

- ▶ CE approval
- ▶ 220Volt, 50HZ, 60W
- ▶ Include 2pcs 11x100MM glue stick
- ▶ In double blister



Item no.	Contents
70 30 20 10	

HOT GLUE GUN KIT

- ▶ GS approval
- ▶ 230Volt, 50 HZ, 15W(40W)
- ▶ Incl. 6 piece Φ11mmx100 mm glue sticks



Item no.	Contents
70 90 00 09	15(40)W

HOT GLUE GUN KIT

- ▶ GS approval
- ▶ 1pc glue gun 230v 10(60)W
- ▶ 1pc glue gun 230V 30(500)W
- ▶ 1pc spare nozzle
- ▶ Incl.3pcs Φ11mmx100 &Φ7.2mmx50 glue sticker



Item no.	Contents
70 90 00 10	10(60)W/30(500)W

RECHARGEABLE HOT GLUE GUN

- ▶ NI-MH battery DC7.2V 1800mAh
- ▶ Charging time:2 hours
- ▶ Working time: 30minutes



Item no.	Contents
70 30 20 06	12(55)W

GLUE STICKS

- ▶ Diameter: 7.2mm/11.2mm any length
- ▶ Available color: red, blue, yellow, green, transparent



Item no.	Contents
70 30 40 01	7.2mm/11.2mm

PLASTIC STRAP BALING PRESS

- ▶ Casting Zinc-alloy base
- ▶ Teeth bar chrome plated
- ▶ Locking filler chrome plated
- ▶ With grips



Item no.	Contents
70 30 20 07	12.5-16mm

IRON STRAP BALING PRESS

- ▶ Casting steel base
- ▶ Plastic coated steel handle with grips
- ▶ Locking filler black finish



Item no.	Contents
70 30 20 08	20-30mm

WHITE GLUE

- ▶ Material: PVA (Polyvinyl Alcohol)
- ▶ Solid Content: 25%+, it depends on working purpose.
- ▶ Appearance: Milky White Liquid
- ▶ Odor: Mild Acetic Aroma
- ▶ Features: Non Toxic, Solvent Free
- ▶ Function: Bond Craft Artworks in home, office and school.
- ▶ Test Reports: EN71 Part1,2,3, TRA, Microbe Tests, ASTM D etc.
- ▶ Available volumes: 37ml, 56ml, 60ml, 70ml, 80ml, 120ml, 250ml, 500ml, 1000ml, 3840ml etc.



Item no.	Contents
70 99 00 01	

SUPER GLUE

- ▶ Al tube3g
- ▶ Bonds metal, wood, ceramic etc.



Item no.	Contents
70 99 00 02	

5 PCS SUPER GLUE

- ▶ Al tube3g
- ▶ Bonds metal, wood, ceramic etc.



Item no.	Contents
70 99 00 04	

SUPER GLUE

- ▶ Plastic bottle 5g
- ▶ Bonds metal, most plastics, wood, leather, ceramic etc.



Item no.	Contents
70 99 00 05	

SILICONE

- ▶ High-strength
- ▶ High strain rate and excellent adhesion
- ▶ Excellent resistance to weather aging properties



Item no.	Contents
70 30 40 02	

POLYURETHANE FOAM SEALANT



Item no.	Contents
70 30 40 03	

TWO COMPONENT HIGH STRENGHT EPOXY ADHESIVE



Item no.	Contents
70 30 40 04	



BOTTLE JACK

- ▶ Hi-quality fitted with unique overland protection system
- ▶ large stable base and saddle.
- ▶ Supplied two-piece handle;
- ▶ GS-approval;



Item no.	Contents
73 10 00 01	2 T
73 10 00 02	3 T
73 10 00 03	5 T
73 10 00 04	8 T
73 10 00 05	10T
73 10 00 06	12T
73 10 00 07	15T
73 10 00 08	20T
73 10 00 09	30T

HYDRAULIC FLOOR JACK

- ▶ Professional, supplied with one piece handle,
- ▶ GS-approval; Specification:
- ▶ Capacity 2250 kg (2.25 tons)
- ▶ Lifting size:145-495mm
- ▶ Overall size: 695x344x180mm
- ▶ N.W.:37 kg;
- ▶ Color box packing



Item no.	Contents
73 10 20 02	2250 kg

HYDRAULIC LONG FLOOR JACK

- ▶ 2000kgs, Min.Height:140mm, Max.Height: 820mm
- ▶ 3000kgs, Min.Height:130mm, Max.Height: 630mm
- ▶ 3000kgs, Min.Height:140mm, Max.Height: 670mm
- ▶ 5000kgs, Min.Height:150mm, Max.Height: 560mm
- ▶ 10000kgs, Min.Height:160mm, Max.Height: 560mm



Item no.	Contents
73 10 20 06	2000kg
73 10 20 07	3000kg
73 10 20 08	5000kg
73 10 20 09	10000kg

LIFTING AND WELDING TOOLS

HYDRAULIC FLOOR JACK

- ▶ Supplied with one piece handle. GS-approval; Specification:
- ▶ Capacity 2000 kg (2 tons)
- ▶ Lifting size:130-350mm
- ▶ Overall size: 492x218x132mm
- ▶ N.W.: 10,5 kg ;
- ▶ Color box packing



Item no.	Contents
73 10 20 01	2000 kg

ALUMINUM RACING JACK

- ▶ A light weight jack of aircraft grade, heat aluminum, hydraulic block and aluminum chassis for easy handling and position under a vehicle.
- ▶ Jack has a built-in safety overload system that prevents use beyond its rated capacity
- ▶ With rear swivel casters, maneuvering and positioning this jack is an easy task
- ▶ Rubber padded saddle protects vehicle frame



Item no.	Contents
73 10 20 03	1500kg

GARAGE JACK

- ▶ Capacity: 3/3.5Ton
- ▶ Min.Height: 145(5-11/16")mm
- ▶ Max.Height: 500(19-11/16")mm
- ▶ N.W.:38kg
- ▶ G.W.: 40kg
- ▶ Products Size: 685x346x180mm
- ▶ Packing Size: 725x355x210mm
- ▶ QTY/20'CY: 480PCS
- ▶ Pallet QTY/20': 26Pallets
- ▶ Master Ctn/ayers: 3-5Ctn/Layer



Item no.	Contents
73 10 20 04	3000kg
73 10 20 05	3500kg

SCISSOR JACK

- ▶ GS/CE-approval, supplied with winding handle. Specification:
- ▶ Capacity 1000 kg (1 ton)
- ▶ Lifting size: 90-350mm;
- ▶ Color box packing



Item no.	Contents
73 10 60 01	1000 kg Lifting size: 90-350mm;
73 10 60 02	1500kg Lifting size:105-380mm

16PCS PORTABLE HYDRAULIC EQUIPMENT

- ▶ Ram Lifting Height<125mm
- ▶ Min. Ram Height: 270mm



Item no.	Contents
73 10 40 01	4T

16PCS PORTABLE HYDRAULIC EQUIPMENT

- ▶ Ram Lifting Height<135mm
- ▶ Min. Ram Height: 358mm



Item no.	Contents
73 10 40 02	10T

AXLE STANDS

- ▶ Specification:
- ▶ Capacity: 3000 kg;
- ▶ Min.Height: 298mm ;
- ▶ Max.Height:428mm;
- ▶ N.w.: 7 kg/pair;
- ▶ Color box packing



Item no.	Contents
73 10 80 01	2000 kg
73 10 80 02	3000 kg
73 10 80 03	6000 kg

FOLDABLE STANDS

- ▶ Capacity:2000 kg;
- ▶ Min. Height:240mm;
- ▶ Max.Height:355mm;
- ▶ N.w.:3 kg/pair;



Item no.	Contents
73 10 80 04	2000 kg
73 10 80 05	3000 kg
73 10 80 06	6000 kg

WELDING CHAIN

- ▶ DIN standard/ASTM standard approved
- ▶ Low carbon steel/alloyed steel
- ▶ Packed in polybag/plastic pail/steel pail



Item no.	Contents
73 20 40 01	φ2.0mm-32mm

CHAIN HOIST

- ▶ GS/CE approval;
- ▶ Gr.80# standard welding chain with heat treatment



Item no.	Contents
73 20 00 01	0.5Tx3m
73 20 00 02	1Tx3m
73 20 00 03	1.5Tx3m
73 20 00 04	2Tx3m
73 20 00 05	3Tx3m
73 20 00 06	5Tx4m
73 20 00 07	10Tx5m
73 20 00 08	20Tx6m

HAND PALLET TRUCK

- ▶ 3 position control handle
- ▶ Top quality hydraulic pump with a slow lowering hand control valve
- ▶ Full adjustable push rods on the forks
- ▶ Tapered fork tips with entry guide roller
- ▶ Heavy duty one piece C section forks 550x1100mm
- ▶ Grease fitting at key points
- ▶ Double Nylon wheels
- ▶ GS/CE-Approval



Item no.	Contents
73 40 00 01	2500kg

SCISSOR LIFT TABLE

- ▶ Valuable material handling for use as a feeding table on assembly line.
- ▶ Structural heavy duty steel construction.
- ▶ Easy action foot operated hydraulic lift for raising table top to desired level.
- ▶ Robust castors with safety wheel guard and brakes on the two swivel castors, for greater safety wheel loading and unloading.
- ▶ Hand operated table descent control.
- ▶ Over load by-pass valve protects operator and pump.
- ▶ Option: chrome plated handle, painted handle, folding handle&solid handle.



Item no.	Contents
73 40 00 02	300kg(280-890M)
73 40 00 03	500kg(280-890M)
73 40 00 04	750kg(410-1000M)
73 40 00 05	1000kg(410-1000M)

HAND PULLER

- ▶ Ratchet system
- ▶ Zinc or chrome-plated
- ▶ Color box packing



Item no.	Contents
73 30 20 01	2T single gear/ 2 hooks
73 30 20 02	2T double gear/ 2 hooks
73 30 20 03	4T single gear / 2 hooks
73 30 20 04	4T double gear/ 2 hooks

HAND WINCH

- ▶ Pressed steel sheet body and bottom
- ▶ Zinc plated
- ▶ With wire rope and hook
- ▶ Plastic handle
- ▶ Color box packing



Item no.	Contents
73 30 20 05	600Lbs
73 30 20 06	800Lbs
73 30 20 07	1000Lbs
73 30 20 08	1200Lbs
73 30 20 09	1600Lbs
73 30 20 10	1800Lbs
73 30 20 11	2000Lbs
73 30 20 12	2500Lbs



HAND WINCH

- ▶ Pressed steel sheet body and bottom
- ▶ Black powder painting
- ▶ With webbing and hook
- ▶ Plastic handle
- ▶ Color box packing



Item no.	Contents
----------	----------

73 30 20 13	600Lbs
73 30 20 14	800Lbs
73 30 20 15	1000Lbs
73 30 20 16	1200Lbs
73 30 20 17	1600Lbs
73 30 20 18	1800Lbs
73 30 20 19	2000Lbs
73 30 20 20	2500Lbs

4PCS LUGGAGE CORD SET

- ▶ 4 pcs cords, folded
- ▶ With ABS ring and wire hook
- ▶ For easy use
- ▶ Plastic bag + head card
- ▶ Contents: 8mmx24"; 8mmx32"; 8mmx36"; 8mmx40"



Item no.	Contents
----------	----------

73 20 60 02	
-------------	--

CAM BUCKLE TIE DOWN

- ▶ PE material
- ▶ Pull strength: less than 5000kgs



Item no.	Contents
----------	----------

73 30 00 02	50mmx8M
-------------	---------

ROPE PULLEY

- ▶ Breaking strength: 500lbs/800lbs
- ▶ Cable: Dia5.0mmx20m
- ▶ 20pcs/ctn



Item no.	Contents
----------	----------

73 20 20 01	500lbs
73 20 20 02	800lbs

WEBBING SLING

- ▶ Made of 100% EPS,



Item no.	Contents
----------	----------

73 20 60 03	
-------------	--

RATCHET TIE DOWN

- ▶ PE material
- ▶ Zinc plated ratchet buckle
- ▶ With S hook
- ▶ Packed in double blister card



Item no.	Contents
----------	----------

73 90 00 01	
-------------	--

ROUND SLING

- ▶ Made of 100% EPS,



Item no.	Contents
----------	----------

73 20 60 04	
-------------	--

2PCS RATCHET TIE DOWN SET

- ▶ PE material
- ▶ Zinc plated ratchet buckle with EPDM coating
- ▶ With S hook
- ▶ Packed on plastic holder



Item no.	Contents
----------	----------

73 30 00 03	
-------------	--

LUGGAGE CORD

- ▶ GS-Approval
- ▶ For quick convenient load binding
- ▶ Elastic design provide constant tension and firm hold
- ▶ Palstic bag+head card packing



Item no.	Contents
----------	----------

73 20 60 01	diameter:8mm, 12mm; length:18", 24", 32", 36", 36", 40", 48", 60", 80"
-------------	------------------------------------------------------------------------------

CAM BUCKLE TIE DOWN

- ▶ PE material
- ▶ Pull strength: less than 250kgs



Item no.	Contents
----------	----------

73 30 00 01	25mmx5m
-------------	---------

4PCS RATCHET TIE DOWN SET

- ▶ PE material
- ▶ Zinc plated ratchet buckle with EPDM coating
- ▶ With S hook
- ▶ Packed on plastic holder



Item no.	Contents
----------	----------

73 90 00 02	
-------------	--

FLOOR PULLER

- ▶ Pull strength: 500/1000/1500/2000LBS



Item no.	Contents
73 30 20 21	1"x10"
73 30 20 22	1"x15"
73 30 20 23	1"x20"

THREE-PLY ROPE

- ▶ Made of Nylon/PP/PE/PP+PE material



Item no.	Contents
73 20 60 05	1/4"x50FT
73 20 60 06	3/8"x50FT

CARGO NET

- ▶ Made of high quality black rubber
- ▶ 12pcs PP material hooks
- ▶ Rope diameter: 6mm



Item no.	Contents
73 20 60 07	60"x84"
73 20 60 08	48"x60"

MOVING PAD

- ▶ PE coating
- ▶ Recycled cotton inner



Item no.	Contents
73 40 20 09	72"x80"

ALUMINUM FOLDABLE HAND DOLLY

- ▶ Completed mounted
- ▶ Strong forkplate of sheet steel
- ▶ Ballbearing rubber wheels
- ▶ Cap acy max. 100 kg



Item no.	Contents
73 40 00 11	100kg

HAND TROLLEY

- ▶ Products weight:10.25
- ▶ Tire size:10"×3.5"
- ▶ Products size:1120*545*435mm
- ▶ Bottom width:185



Item no.	Contents
73 40 00 12	200kg

WHEEL BARROW

- ▶ Products weight:12.3kg
- ▶ Work capacity:100kg,
- ▶ Wheel size:13"×3"
- ▶ Products size:775*500*290mm



Item no.	Contents
73 40 00 13	100kg

PLATFORM HAND TRUCK

- ▶ Products weight:9.2kg
- ▶ Work capacity:150kg,
- ▶ Wheel size:4"
- ▶ Bottom size:738*479mm



Item no.	Contents
73 40 00 14	150kg

PLATFORM PULL TRUCK

- ▶ Wooden board



Item no.	Contents
73 40 00 15	150kg

ADJUSTABLE PLANT MOVER

- ▶ Steel tube with roller wheel



Item no.	Contents
73 40 00 16	L:30-45cm x H:9cm

PLANT SHELF

- ▶ Steel wire with powder painting with roller wheel

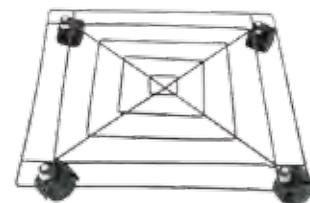

Item no.	Contents
73 40 00 17	L:33cm x W:33cmxH:7cm



PLANT SHELF

- ▶ Steel wire with powder painting with roller wheel



Item no.	Contents
73 40 00 18	Height:12.5cm, Diameter:25.5cm
73 40 00 19	Height:12.5cm, Diameter:30.5cm

MOVING PAD

- ▶ Soft material pad
- ▶ Round shape/hexagon shape/eight square shape



Item no.	Contents
73 40 00 23	

SUCTION DENT PULLER

- ▶ Aluminum body
- ▶ With 2 suction cup
- ▶ Cup diameter 11.5mm for car
- ▶ Windown mirror door etc.
- ▶ Heavy things without taking
- ▶ Color box packing



Item no.	Contents
73 40 20 03	80kgs

PLANT SHELF

- ▶ Steel wire with powder painting with roller wheel



Item no.	Contents
73 40 00 20	Height:7cm, Diameter:25.5cm

SUPER CARGO TIE DOWN

- ▶ Plastic handle
- ▶ 2-ply polyester webbing belt
- ▶ Double blister packing



Item no.	Contents
73 30 00 04	1"x6FT

SUCTION DENT PULLER

- ▶ Plastic body
- ▶ With 2 suction cup
- ▶ Cup diameter 11.5mm for car
- ▶ Windown mirror door etc.
- ▶ Heavy things without taking
- ▶ Color box packing



Item no.	Contents
73 40 20 04	50kgs

MOVING PAD

- ▶ Pressed steel with powder painting
- ▶ With roller wheel



Item no.	Contents
73 40 00 21	

SUCTION CUP

- ▶ Aluminum body
- ▶ Cup diameter 11.5mm for car
- ▶ Windown mirror door etc.
- ▶ Heavy things without taking
- ▶ Color box packing



Item no.	Contents
73 40 20 01	50kgs

SUCTION DENT PULLER

- ▶ Aluminum body
- ▶ With 3 suction cup
- ▶ Cup diameter 11.5mm
- ▶ For car, windown mirror door etc.
- ▶ Heavy things without taking
- ▶ Color box packing



Item no.	Contents
73 40 20 05	100kgs

MOVING PAD

- ▶ ABS with soft pad
- ▶ With roller wheel



Item no.	Contents
73 40 00 22	

SUCTION CUP

- ▶ Plastic body
- ▶ Cup diameter 11.5mm for car
- ▶ Windown mirror door etc.
- ▶ Heavy things without taking
- ▶ Color box packing



Item no.	Contents
73 40 20 02	25kgs

SUCTION DENT PULLER

- ▶ Plastic body
- ▶ With 3 suction cup
- ▶ Cup diameter 11.5mm for car
- ▶ Windown mirror door etc.
- ▶ Heavy things without taking
- ▶ Color box packing



Item no.	Contents
73 40 20 06	75kgs

SUCTION DENT PULLER

- ▶ Aluminum body
- ▶ With 4 suction cup
- ▶ Cup diameter 11.5mm.
- ▶ For car, windown mirror door etc.
- ▶ Heavy things without taking
- ▶ Color box packing



Item no.	Contents
73 40 20 07	125kgs

SUCTION DENT PULLER

- ▶ Plastic body
- ▶ With 4 suction cup
- ▶ Cup diameter 11.5mm
- ▶ For car, windown mirror door etc.
- ▶ Heavy things without taking
- ▶ Color box packing



Item no.	Contents
73 40 20 08	100kgs

EUROPEAN CROWBAR

- ▶ Forged carbon steel with heat treatment
- ▶ With black finish
- ▶ Polished head



Item no.	Contents
73 40 40 01	12"x13mm
73 40 40 02	18"x16mm
73 40 40 03	24"x16mm
73 40 40 04	30"x16mm
73 40 40 05	36"x18mm

HALF-HOOKED CROW BAR

- ▶ Forged carbon steel with heat treatment
- ▶ With black finish
- ▶ Polished head



Item no.	Contents
73 40 40 06	12"x13mm
73 40 40 07	18"x16mm
73 40 40 08	24"x16mm
73 40 40 09	30"x16mm
73 40 40 10	36"x18mm

CROW BAR WITH RUBBER COVER

- ▶ Forged carbon steel with heat treatment
- ▶ With black finish
- ▶ Polished head



Item no.	Contents
73 40 40 11	12"x13mm

T-TYPE CROWBAR

- ▶ Forged carbon steel with heat treatment
- ▶ With black finish
- ▶ Polished head



Item no.	Contents
73 40 40 12	12"
73 40 40 13	24"
73 40 40 14	30"
73 40 40 15	36"

EUROPEAN CROWBAR

- ▶ Forged carbon steel with heat treatment
- ▶ With black finish
- ▶ Polished head



Item no.	Contents
73 40 40 16	13-21"

4PCS ROUND LEVER NAIL PULLER SET

- ▶ Forged carbon steel with heat treatment
- ▶ With black finish
- ▶ Polished head
- ▶ Color box packing



Item no.	Contents
73 90 00 03	8"
	12"
	16"
	20"

4PCS PRY BAR SET

- ▶ Forged carbon steel with heat treatment
- ▶ With black finish
- ▶ Polished head
- ▶ Plastic handle
- ▶ Color box packing



Item no.	Contents
73 90 00 04	24"
	36"
	42"
	52"



QUALITY HAND PUMP

- ▶ Iron body, powder coating



Item no.	Contents
75 10 00 01	Φ38x450mm

HAND PUMP

- ▶ Aluminum Tube, plastic handle; With tank and gauge, with adapter-set, fixed hose by chain for inflating tires of cars, motor-cycle and bicycles, rubber boats and so on



Item no.	Contents
75 10 00 02	Φ38x450mm

QUALITY HAND PUMP

- ▶ Plastic body



Item no.	Contents
75 10 00 03	Φ38x530mm

FOOT PUMP

- ▶ GS-approval; With adapter-set, fixed to hose by chain, for inflating tires of cars, motor-cycle and bicycles, rubber boats, balls balloons and so on; Rubber coated feet for safe positioning; With a dial-type pressure gauge marked 0-100psi and 0-7kg/cm2(0-7bar); Color box packing



Item no.	Contents
75 10 20 01	Φ120x55mm

DOUBLE CYLINDER FOOT PUMP

- ▶ GS-approval; Suitable for applications where a high volume of air or fast pumping action is required. with adapter-set, fixed to hose by chain, for inflating tires of cars, motor-cycle and bicycles, rubber boats, balls balloons and so on; Rubber coated feet for safe positioning; With a dial-type pressure gauge marked 0-100psi and 0-7kg/cm2(0-7bar) ; Color box packing



Item no.	Contents
75 10 20 02	2xΦ120x55mm

AIR COMPRESSOR

- ▶ Suitable for the inflating of tyres, dinghies and sports equipment. Powered by the way of car cigarette lighter socket. Supplied complete with 12V/ DC car cigarette lighter plug. Two inflating adapter nozzles, one needles valve adapter and hose with clip-on tyres connector. Color box packing



Item no.	Contents
75 10 20 03	250 PSI

AIR COMPRESSOR

- ▶ Suitable for inflating tyres on cars, vans, 4x4s and lorries in 1.5 min. Automatic overload relay Gauge reads up to max. pressure of 10 bar/ 140 psi Max.air consumption 35 L/min Supply voltage 12V by cigarette lighter plug Water resistant; Accessory kit containing ball spikes, adaptors for bicycle tyres and air beds; With nylon carrier bag Different colors are available



Item no.	Contents
75 10 20 04	

AIR COMPRESSOR

- ▶ Suitable for inflating tyres on Bus, cars, vans, Truck 4x4s pressure of 7 bar/ 100 psi Max.air consumption 35 L/ min Supply voltage 12V by cigarette lighter plug Water resistant; Accessory kit containing ball spikes, adaptors for bicycle tyres and air beds; With nylon carrier bag Different colors are available



Item no.	Contents
75 10 20 05	

VEHICLE REPAIRING

ADJUSTABLE STRAP WRENCH

- ▶ Black rubber strap, 2 components PP+TPR handle



Item no.	Contents
75 40 80 01	4"x100mm
75 40 80 02	6"x150mm

DROP FORGED OIL FILTER WRENCH

- ▶ Heavy duty drop-forged slip joint wrench with double dipped comfort grip handle
- ▶ Fits 2-1/2"-3-1/2" filters



Item no.	Contents
75 40 80 03	

9"/10" OIL FILTER WRENCH

- ▶ Serrated jaws with spring loaded adjustment
- ▶ With double dipped comfort grip handle
- ▶ Fits 60MM-90MM / 80MM-120MM filters



Item no.	Contents
75 40 80 04	

JAWS OIL FILTER WRENCH

- ▶ Universal one-handed design
- ▶ Jaw slide open to fit around canister
- ▶ Fits 3" to 4" filters



Item no.	Contents
75 40 80 05	

3-PRONG OIL FILTER WRENCH

- ▶ 2-way, with 3/8" square drive
- ▶ 21mm male hexagon
- ▶ Fits 1-3/4" to 2-7/8" filters



Item no.	Contents
75 40 80 06	

3-PRONG OIL FILTER WRENCH

- ▶ 2-way, with 3/8" square drive
- ▶ 21mm male hexagon
- ▶ Fits 2-1/2" to 4-1-2" filters



Item no.	Contents
75 40 80 07	

3-PRONG OIL FILTER WRENCH

- ▶ 2-way, with 3/8" square drive
- ▶ 21mm male hexagon
- ▶ Fits 2-1/2" to 4" filters



Item no.	Contents
75 40 80 08	

CLINCHER TYPE OIL FILTER WRENCH

- ▶ Adjustable for a wide range of filters
- ▶ Has a cushioned gri for maximum comfort and safety
- ▶ Fit 3-5/8" - 3-3/4" P(75mm-95mm)



Item no.	Contents
75 40 80 09	

SWIVEL HANDLE OIL FILTER WRENCH

- ▶ 90-degree swivel to access filters in confined areas
- ▶ With stainless steel band
- ▶ Black wide band resists corrosion and prevent the filter form being crushed
- ▶ Dimples on band and vinyl handle ensure a positive grip
- ▶ a) Fits 2-3/8" to 2-7/8" filters
- ▶ b) Fits 3-7/8" to 3-3/8" filters
- ▶ c) Fits 3-3/8" to 3-3/4" filters
- ▶ d) Fits 3-3/4" to 4-3/8" filters



Item no.	Contents
75 40 80 10	

NYLON STRAP OIL FILTER WRENCH

- ▶ Sturdy non-slip nylon strap handles spin-type
- ▶ Use 1/2" square drive tool
- ▶ Fits 6" filters



Item no.	Contents
75 40 80 11	

SEAL PULLER

- ▶ Removes oil & grease seals
- ▶ Two tips fit most application



Item no.	Contents
75 99 00 01	

TRIM PAD REMOVER

- ▶ For quickly releasing door panel and upholstery clips
- ▶ Reduce damage to panels and loss of clips



Item no.	Contents
75 99 00 02	

DOOR HANDLE CLIP REMOVER

- ▶ For removing spring clips used to retain door and window handles
- ▶ Allows handle to be removed with the spring clip still on the post
- ▶ Tool compressor door handle spring just far enough so that handle can be removed
- ▶ Fits GM, FORD & other cars using "C" type clip



Item no.	Contents
75 99 00 03	

DOOR HANDLE CLIP REMOVER

- ▶ Multipurpose panel beating tool for removing and installing auto trim fittings & fixtures
- ▶ Tempered spring steel
- ▶ Includes:
 - ▶ 1-Headlam spring tool
 - ▶ 2-Windshield molding clip remover
 - ▶ 3-Door rubber plastic clip remover
 - ▶ 4-Serrated edge for panel seam detail neatening
 - ▶ 5-Molding remover
 - ▶ 6-Windshield wiper wrech
 - ▶ 7-Door rubber metal clip inserter
 - ▶ 8-Door weather strip clip remover
 - ▶ 9-Door handle clip remover
 - ▶ 10-Door trim bezel clip remover



Item no.	Contents
75 99 00 04	



SPARK PLUG BOOT PULLER

- ▶ For pulling boot off of spark plug
- ▶ Compact "L" - shaped boot puller pulls boot from the base to avoid damage to the wire connecting



Item no.	Contents
75 99 00 05	

EXTERNAL SNAP RING PLIERS

- ▶ For removing the installing external snap rings
- ▶ Straight 45 degree and 90 degree angle tips are included in a clear plastic storage box
- ▶ Comfort grip handles



Item no.	Contents
75 99 00 06	

INTERNAL SNAP RING PLIERS

- ▶ For removing and installing internal snap rings
- ▶ Straight 45 degree and 90 degree angle tips are included in a clear plastic storage box
- ▶ Comfort grip handles



Item no.	Contents
75 99 00 07	

RETURN SPRING PLIERS

- ▶ For removing and installing return springs on brakes where the return spring hooks over a post



Item no.	Contents
75 99 00 08	

HOSE CLAMP PLIERS

- ▶ For corbin style and other hose clamps 2 pairs jaws included ratchet handle lock holds pliers in clamp-open position for easy removal and installation



Item no.	Contents
75 99 00 09	

MINI RAZOR BLADE SCRAPER

- ▶ Offset scraping head and short handle are great for tight scraping jobs
- ▶ Each scraper has a rubber coated handle
- ▶ Each pieces comes complete with a blade



Item no.	Contents
75 99 00 10	

11" GASKET SCRAPER

- ▶ Designed to reach in tight places to remove stickers from windshields, bumpers, etc.
- ▶ Comes with three blades
- ▶ Knurled, slotted thumbscrew for easy change of blades
- ▶ Hollow handle stores all blades when not in use



Item no.	Contents
75 99 00 11	

2PC O-RING & HOOK SCRIBE SET

- ▶ Ideal for facilitating the removal and installation of o-rings and seals
- ▶ Also suitable for retrieving small items in confined areas
- ▶ Knurled handle design to ensure positive grip



Item no.	Contents
75 99 00 14	

ADJUSTER SPOON

- ▶ For adjusting clearance between brake shoes and drum
- ▶ Rotates brake star wheel adjuster through a hole in backing plate
- ▶ The size: 9" overall length



Item no.	Contents
75 99 00 15	

BALL JOINT SEPARATOR

- ▶ Wedge-type tool for separation tie rod end from steering knuckle
- ▶ Size:11-3/4"



Item no.	Contents
75 99 00 16	

2PC DOUBLE CUP VALVE GRINDERS

- ▶ For hand lapping valves and valve seats
- ▶ Hardwood handles, 9" tool with 1-1/8" cups, 8" tool with 5/8" and 13/16" cups
- ▶ Synthetic rubber cups are resistant to chemical agents
- ▶ Non-slip cups are groove locked to handle



Item no.	Contents
75 90 00 01	

TELESCOPING INSPECTION MIRROR

- ▶ Inspection mirror 1-1/4"(dia)
- ▶ Telescopic from 6-7/8" to 19-3/4"
- ▶ The material is brass tube



Item no.	Contents
75 99 00 17	

TELESCOPING INSPECTION MIRROR

- ▶ Inspection mirror 1-1/4"(dia)
- ▶ Telescopic from 8" to 35"
- ▶ The material is stainless steel



Item no.	Contents
75 99 00 18	

TELESCOPING MAGNETIC PICK-UP TOOL

- ▶ The magnetic power is 35 LBS / 6LBS
- ▶ Telescopic from 5" TO 24-3/4" / 5-1/4" TO 25-3/8"
- ▶ The material is brass tube



Item no.	Contents
75 45 00 01	

TELESCOPING MAGNETIC PICK-UP TOOL

- ▶ The magnetic power is 15LBS / 35LBS / 5LBS
- ▶ Telescopic from 5" to 25" / 5-1/8" to 25-1/4" / 5-1/8" to 23-3/4"
- ▶ The material is brass tube



Item no.	Contents
75 45 00 02	

TELESCOPING MAGNETIC PICK-UP TOOL

- ▶ The magnetic power is 2LBS/5LBS/8LBS
- ▶ Telescopic from 6-1/2" to 33"
- ▶ The material is stainless steel



Item no.	Contents
75 45 00 03	

TELESCOPING MAGNETIC PICK-UP TOOL

- ▶ The magnetic power is 16LBS
- ▶ Telescopic from 7-3/8" to 30"
- ▶ The material is stainless steel



Item no.	Contents
75 45 00 04	

FLEX MAGNETIC PICK-UP TOOL

- ▶ The magnetic power is 15LBS
- ▶ Overall length 19-3/4" / 24"



Item no.	Contents
75 99 00 19	

LIGHTED MAGNETIC PICK-UP TOOL

- ▶ Light shines through a hole in the magnet illuminates and retrieves metal objects in darkened areas
- ▶ Turn head clockwise to turn on , counter clockwise to turn off
- ▶ The magnetic power is 5LBS
- ▶ Overall length 22-1/4"



Item no.	Contents
75 99 00 20	

FLEX FLASHLIGHT

- ▶ Shock-resistant oxide aluminum body
- ▶ Water-resistant O-ring seal
- ▶ One mini bulk with 2AA battery
- ▶ But not including the battery



Item no.	Contents
75 99 00 21	

4 JAWS PICK-UP TOOL

- ▶ The head with 4 jaws for pick up tools
- ▶ Overall length 24"



Item no.	Contents
75 45 00 05	

2PC MAGNETIC PICK UP TOOL AND INSPECTION MIRROR SET

- ▶ 1pc telescoping inspection mirror with 2-1/4" mirror
- ▶ 1pc telescoping magnetic pick up tool The magnet power is 8LBS
- ▶ 1pc 8LBS pick up head
- ▶ 1pc 35LBS pick up head



Item no.	Contents
75 90 00 02	

MAGNETIC PARTS TRAY-4"/6"

- ▶ Stainless steel magnetic parts tray is perfect for holding those easy to lose small parts
- ▶ Strong magnetic base is covered with rubber



Item no.	Contents
75 45 20 01	

MAGNETIC PARTS TRAY-5.5"X9.5"

- ▶ Stainless steel magnetic parts tray is perfect for holding those easy to lose small parts
- ▶ Strong magnetic base is covered with rubber



Item no.	Contents
75 45 20 02	

SUPER SIZE MAGNETIC PARTS TRAY

- ▶ High polish stainless steel magnetic parts tray
- ▶ Four powerful, rubber covered magnetic hold tray securely to steel surfaces



Item no.	Contents
75 45 20 03	

MAGNETIC TOOL HOLDER

- ▶ Mount magnetic, Bar to organize, Shop garage, home commercial and more
- ▶ Maximum capacity of bar 30lbs(1364kg)
- ▶ Magnet strength 1000-1200 gauss



Item no.	Contents
75 45 20 04	

4PCS MAGNETIC TRAY, BAR TOOL SET

- ▶ 2pc 18-3/8" magnetic tool holder
- ▶ 1pc 5-1/2" x 9-1/2" magnetic tray
- ▶ 1pc 6" magnetic bowl
- ▶ 1pc 5LBS telescoping magnetic pick-up tool



Item no.	Contents
75 90 00 03	



MAGNETIC PICK-UP PAL

- ▶ Ability:50lbs



Item no.	Contents
75 99 00 23	

MAGNETIC WRIST BAND



Item no.	Contents
75 99 00 24	

DROP-FORGED COIL SPRING COMPRESSOR

- ▶ Drop-forged carbon steel jaws&lead screw both heat-treated ensure you obtain professional job performance
- ▶ The tool is designed for use in limited space under wheel arch
- ▶ Jaws design is fitting to wrap coil claws for safety



Item no.	Contents
75 99 00 25	

3-JAW GEAR PULLER

- ▶ Jaws drop-forged, Triangular thread 3"-4"-6"-8"...28"



Item no.	Contents
75 40 00 01	

2-JAW GEAR PULLER

- ▶ Jaws drop-forged, Triangular thread 3"-4"-6"-8"...28"



Item no.	Contents
75 40 00 02	

DROP FORGED 3-JAW GEAR PULLER

- ▶ Jaws drop-forged, Beam drop-forged, T-shaped thread 3"-4"-6"-8"-10"



Item no.	Contents
75 40 00 03	

DROP FORGED 2-JAW GEAR PULLER

- ▶ Jaws drop-forged, Beam drop-forged, T-shaped thread 3"-4"-6"-8"-10"



Item no.	Contents
75 40 00 04	

3-ARM GEAR PULLER

- ▶ Joint plate and jaw drop-forged 80mm,120mm



Item no.	Contents
75 40 00 12	

2-ARM GEAR PULLER BAR TYPE

- ▶ Beam drop-forged
- ▶ Joint plate and jaws, drop-forged, heat treatment
- ▶ Protective case on screw top for easily use 70mm,80mm,105mm,120mm,120mm,160mm,160mm,195mm,



Item no.	Contents
75 40 00 13	

BEARING SEPARATOR

- ▶ Drop forged with CrV steel 2",3",4"



Item no.	Contents
75 99 00 26	

2 SETS BEARING SEPARATOR ASSEMBLY

- ▶ 2" and 3"



Item no.	Contents
75 90 00 04	

9PC STEERING WHEEL PULLER

- ▶ 1pc yoke drop forged
- ▶ 2pc-washer bolt 3/8" - 16x76mm
- ▶ 2pc-washer bolt 5/16-18"x88mm
- ▶ 2pc-washer bolt 5/16-24"x76mm



Item no.	Contents
75 90 00 05	

INTERNAL & EXTERNAL PULLER

- ▶ Internal Dia 15-30mm;30mm-80mm / External Dia:15-80mm



Item no.	Contents
75 40 00 14	

HYDRAULIC GEAR PULLER AVOID ADJUSTING

- ▶ Jaws drop-forged with high quality carbon steel Longs stroke, pulling the article only one time Unique design for easy using Spring draw back or under loading 15T/3T/5T/10T



Item no.	Contents
75 40 00 15	

NUT SPLITTER

- ▶ 9-12MM 12-16MM 16-22MM 19-24MM/



Item no.	Contents
75 40 40 01	

HYDRAULIC NUT SPLITTER

- ▶ 7-22MM 22-36MM



Item no.	Contents
75 40 40 02	

2PC.NUT SPLITTER

- ▶ For splitting rusted or corroded nuts up to 5/8"
- ▶ Compact 5" length heat-treated cutter, plated body



Item no.	Contents
75 40 40 03	

9PCS 1/2"DR.DAMAGED BOLT/NUT REMOVER SET

- ▶ Include:10,11,12,13,14,15,16,17,19mm
- ▶ CRV steel



Item no.	Contents
75 90 00 06	

6PCS EXTRACTOR SET



Item no.	Contents
75 90 00 07	

8PCS EXTRACTOR SET



Item no.	Contents
75 90 00 08	

MINI PENCIL TYPE TIRE GAUGE

- ▶ 5-50PSI ,Plastic head



Item no.	Contents
75 99 00 29	

TIRE OPENER

- ▶ Drop forged with Cr-V steel



Item no.	Contents
75 99 00 51	300MM
	400MM
	500MM
	600MM

6PCS 1/2"DR CROWS FOOT SET



Item no.	Contents
75 90 00 09	1-5/8"
	1-3/4"
	1-7/8"
	2"
	2-1/8"
	2-1/4"

PENCIL TYPE TIRE GAUGE

- ▶ 5-50PSI , 10-120PSI
- ▶ Metal head



Item no.	Contents
75 99 00 28	

DIAL TYPE TIRE GAUGE

- ▶ 10-50PSI



Item no.	Contents
75 99 00 30	



DIAL TYPE TIRE GAUGE

- ▶ 10-75PSI



Item no.	Contents
75 99 00 31	

2 IN 1 DIGITAL TIRE GAUGE

- ▶ Tire depth and tire pressure measurement for the home or business accuracy within most countries operating standards. Functions: Check tire PRESSURES in psi or bar from 0 - 120 psi; Accuracy (@25 °C): ≤±1% psi; ≤±0.1% bar; Check tire tread DEPTH 0-15.8mm; Accuracy ±0.3mm



Item no.	Contents
75 99 00 32	

DIGITAL TIRE GAUGE

- ▶ Maintain correct tire pressures; Reduce tire wear and extend tire life; Increase fuel efficiency; Improve vehicle handling and safety Specifications: Ranges:2.0-99.5 PSI & 0.15-7.00 BAR; Display:25mm LCD; Power:3V lithium coin cell; Operating temperature:0 - 40°C



Item no.	Contents
75 99 00 33	

DIGITAL TIRE GAUGE

- ▶ Maintain correct tire pressures; Reduce tire wear and extend tire life; Increase fuel efficiency; Improve vehicle handling and safety; Specifications: Ranges:2.0-99.5 PSI & 0.15-7.00 BAR; Display:25mm LCD; Power:3V lithium coin cell; Operating temperature:0 - 40°C



Item no.	Contents
75 99 00 34	

MINI DIGITAL TIRE GAUGE

- ▶ 5.0-100PSI(0.35-7.00Bar)
- ▶ Display:6*10mm LCD
- ▶ Automatic shut-off
- ▶ CE approved
- ▶ Operating temperature:-5 - 50°C



Item no.	Contents
75 99 00 35	

BATTERY HYDROMETER

- ▶ With suction ball and plastic tube
- ▶ Easy operation by coloured measuring spindle:red area=recharge immediately ;blue area=50%;yellow area=battery ok



Item no.	Contents
75 99 00 36	

GAS PRESSURE TIPE INDICATOR

- ▶ valve cap, brass, 2.0



Item no.	Contents
75 99 00 37	

MOBILE TELEPHONE HOLDER



Item no.	Contents
75 99 00 38	

MOBILE TELEPHONE HOLDER



Item no.	Contents
75 99 00 39	

CAR ANTENNA



Item no.	Contents
75 99 00 40	

TWIN AIR HORN



Item no.	Contents
75 99 00 41	

TOW BALL



Item no.	Contents
75 99 00 42	

10 PCS CAR FUSE SET

- ▶ 3A/5A/7.5A/10A/2/15A/20A/2/25A/30A

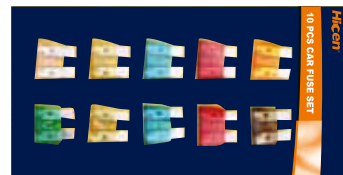

Item no.	Contents
75 90 00 10	

TOWING BRACE

- ▶ GS-approval; Specification: Capacity: 2000kg(2 Tons); Max. Distance between hooks:>1800mm; color box packing



Item no.	Contents
75 70 00 01	2000 Kg

TOWING BELT



Item no.	Contents
75 70 00 02	2"×2m 5000Kg

TOW ROPE

► Specification: Capacity: 2800 Kg; Size: 3 m



Item no.	Contents
75 70 00 03	2800 Kg

PORTABLE WARNING SIGNS



Item no.	Contents
75 60 00 01	

WARNING TRIANGLE



Item no.	Contents
75 60 00 02	

WARNING LIGHT

- Spotlight/softlight/blinking light
- softlight:bulb
- Use seperately or together
- With DC12V automobile cigarette lighter plug
- Use 6"C"size batteries(not included)
- Main material:ABS/PS



Item no.	Contents
75 60 00 03	

JUMP START

- Power out put : 12V/ DC, 900AMP, peak ; 400 AMP starting power
- Batteries type : sealed lead Acid, Rechargeable 17 AMP-Hours
- Features : safety switch, overload protection AC/DC power pack 12V / 3W indication light, volt meter
- Color box



Item no.	Contents
75 20 00 01	

BOOSTER CABLE

► Brass clamp ABS-coated, PVC-insulation cable ; GS-approval



Item no.	Contents
75 20 20 01	Φ16mm 2x3m,
75 20 20 02	Φ25mm 2x3.5m

OIL CAN

► Angled rigid spout, chrome plated; Iron body; Powder finish;O-seal ring in cover; Iron Robust pump, zinc plated



Item no.	Contents
75 30 20 02	200ML
75 30 20 03	300ML
75 30 20 04	500ML
75 30 20 05	600ML

OIL CAN

► Flexible spout, chrome plated; Iron body; Powder finish;O-seal ring in cover; Iron Robust pump, zinc plated



Item no.	Contents
75 30 20 06	200ML
75 30 20 07	300ML
75 30 20 08	500ML
75 30 20 09	600ML

OIL CAN

► Angled rigid spout, chrome plated; Iron body; Powder finish;O-seal ring in cover; Iron Robust pump, zinc plated



Item no.	Contents
75 30 20 10	200ML
75 30 20 11	300ML
75 30 20 12	500ML
75 30 20 13	600ML

OIL CAN

► Flexible spout, chrome plated; Iron body; Powder finish;O-seal ring in cover; Iron Robust pump, zinc plated



Item no.	Contents
75 30 20 14	200ML
75 30 20 15	300ML
75 30 20 16	500ML
75 30 20 17	600ML

OIL CAN

► Angled rigid spout, powder plated; Iron body; Powder finish; O-seal ring in cover; Brass Robust pump



Item no.	Contents
75 30 20 18	1 PINT

OIL CAN

► Angled rigid spout, powder plated; Iron body; Powder finish; O-seal ring in cover; Brass Robust pump



Item no.	Contents
75 30 20 19	6OZ



OIL CAN

- ▶ Flexible spout, metal plated; Iron body; Powder finish; O-seal ring in cover; Iron robust pump, zinc plated



Item no.	Contents
75 30 20 20	6OZ

OIL CAN

- ▶ Flexible spout, metal plated; Iron body; Powder finish; O-seal ring in cover; Iron robust pump, zinc plated



Item no.	Contents
75 30 20 21	6OZ

OIL CAN

- ▶ Angled rigid spout, powder plated; Iron body; Powder finish; O-seal ring in cover; Brass Robust pump



Item no.	Contents
75 30 20 22	180CC

OIL CAN

- ▶ Flexible spout; Iron body; Powder finish; O-seal ring in cover; Iron robust pump, zinc plated



Item no.	Contents
75 30 20 23	180CC

OIL CAN

- ▶ Plastic body; High pressure; Metal push handle, chrome plated



Item no.	Contents
75 30 20 24	

4 PIECE FUNNEL SET

- ▶ Plastic, 50, 75, 95, 115mm with hooks.



Item no.	Contents
75 30 20 25	

FUNNEL



Item no.	Contents
75 30 20 26	

LEVER GREASE GUN

- ▶ Germany type, has all features of standard lever gun plus 2 inlets in the head of eliminated the need for full stroke in tight places. Includes linger grip handle on the lever, air bleeder valve, filter fitting, 1/2 straight grease pipe and coupler.



Item no.	Contents
75 30 20 27	400CC
75 30 20 28	500CC

BARREL PUMP

- ▶ Metal, chrome-plated, with telescope tube, 20l/min; Color box packing



Item no.	Contents
75 30 20 29	

MINI GREASE GUN

- ▶ Useful tool for greasing garden machinery and automotive vehicles; In color box.



Item no.	Contents
75 30 20 30	100CC

PROFESSIONAL HEAVY DUTY GREASE GUN

- ▶ Black finish body with heavy duty spring and plunger assembly; Side level action. Suitable for cartridge or bulk filling; With flexible tube, rigid tube; In color box



Item no.	Contents
75 30 20 31	500CC

LEVER GREASE GUN

- ▶ Chrome-plated body with heavy duty spring and plunger assembly; completely with delivery tube and hydraulic connector. Side lever action. Suitable for grease cartridge loading. With flexible tube, rigid tube; In color box.



Item no.	Contents
75 30 20 32	500CC

PROFESSIONAL GREASE GUN

- ▶ Chrome-plated body with heavy duty spring and plunger. Lever action for using with standard grease gun cartridges and bulk. Supplied complete with delivery tube. In color box



Item no.	Contents
75 30 20 33	500CC

HEAVY DUTY GREASE GUN

▶ Completely professional black finished. With heavy duty spring and plunger. Side lever action. Suitable for grease cartridge loading. With flexible tube. In color box



Item no.	Contents
75 30 20 34	500 CC

AIR GREASE GUN

▶ Pistol-type, single shot gun suitable for agricultural, automotive and industrial applications. Three methods of grease loading, available: standard 400 cartridges, filler pump and bulk. With rigid and flexible tubes. In color box



Item no.	Contents
75 30 20 35	

GREASE GUN SET

▶ 1pc Pistol type Grease Gun in chrome-plating; 1 pc. High pressure hose in 300mm; 2 pc. Nozzle tube in 95mm and 145mm; 1 pc. Hydraulic mouth in M10X1; 1 pc. Grease cartridge in 120cc (around 85g); Suitable for standard fittings; In double blister package



Item no.	Contents
75 30 20 36	120CC

SAFETY WHEEL CHOCK



Item no.	Contents
75 99 00 43	

PNEUMATIC CAR CREEPER SEAT



Item no.	Contents
75 99 00 44	390X390X547MM

CREEPER SEAT



Item no.	Contents
75 99 00 45	414X360X365MM

FOLDABLE STEEL CAR CREEPER



Item no.	Contents
75 99 00 46	1006X440X105MM

ENGINE STAND

- ▶ *Square steel tube
- ▶ *Powder coating surface
- ▶ *Steel holder with heat treatment
- ▶ *With rolling wheel



Item no.	Contents
75 99 00 47	750lbs 1000lbs 1250lbs 1500lbs 2000lbs

ENGINE CRANE

- ▶ *Hydraulic structure,
- ▶ *adjustable arm length
- ▶ *Square steel tube
- ▶ *Powder coating surface
- ▶ *Forged carbon steel hook with heat treatment, Zinc plated
- ▶ *With rolling wheel



Item no.	Contents
75 99 00 48	0.75T 1T 2T

MOTORCYCLE LIFT TABLE

- ▶ *GS-Approval
- ▶ *Min.Height:110mm(4-5/16")
- ▶ *Max.Height:385mm(15-1/8")



Item no.	Contents
75 99 00 49	680kgs

MOTORCYCLE LIFT TABLE

- ▶ *Min.Height:195mm
- ▶ *Max.Height:780mm
- ▶ *Platform size:1825x660mm
- ▶ *Leading plate: 690x660mm



Item no.	Contents
75 99 00 50	450kgs

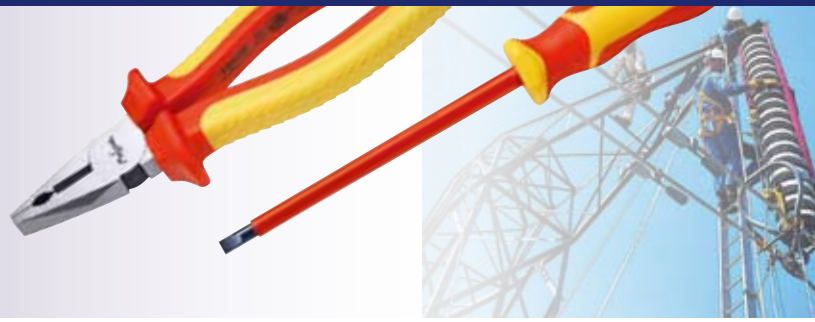

VOLTAGE TESTER

- ▶ Metal blade with transparent handle
- ▶ Neon light
- ▶ 100-250V
- ▶ VDE / GS / CE



Item no.	Contents
80 10 00 01	3x140

DIGITAL VOLTAGE TESTER

- ▶ Metal blade
- ▶ Plastic handle with digital indication
- ▶ 100-250V
- ▶ GS/CE



Item no.	Contents
80 10 00 05	150mm 190mm

VOLTAGE TESTER

- ▶ 6/12/24/50/120/230/400V
- ▶ LED digital indication
- ▶ GS/CE



Item no.	Contents
80 10 00 09	

VOLTAGE TESTER

- ▶ Metal blade with transparent handle
- ▶ Neon light
- ▶ 100-250V
- ▶ VDE / GS / CE



Item no.	Contents
80 10 00 02	3.5x190

VOLTAGE TESTER

- ▶ Metal blade with transparent handle
- ▶ Neon light
- ▶ 100-250V
- ▶ CE



Item no.	Contents
80 10 00 06	3x140mm

VOLTAGE TESTER

- ▶ 10-50VDC LED digital show
- ▶ CE



Item no.	Contents
80 10 00 10	

VOLTAGE TESTER

- ▶ Metal blade with transparent handle
- ▶ Neon light
- ▶ 100-250V
- ▶ GS / CE



Item no.	Contents
80 10 00 03	4x190mm

DIGITAL VOLTAGE TESTER

- ▶ 12/36/55/110/220V
- ▶ LED indicator & LCD digital readout
- ▶ no batteries needed
- ▶ continuity check
- ▶ CE



Item no.	Contents
80 10 00 07	3x130mm

VOLTAGE TESTER

- ▶ 2/3/4/5/9/12/12.5/13.5V
- ▶ LED digital show
- ▶ CE



Item no.	Contents
80 10 00 11	

VOLTAGE TESTER

- ▶ Metal blade with transparent handle
- ▶ Neon light
- ▶ 100-250V
- ▶ GS / CE



Item no.	Contents
80 10 00 04	3x140mm

VOLTAGE TESTER

- ▶ 70-1000VAC/50-60Hz
- ▶ CE/UL



Item no.	Contents
80 10 00 08	

CIRCUIT TESTER

- ▶ One hand wire
- ▶ With coiled cord
- ▶ Stainless steel probe
- ▶ Use replacement bulb
- ▶ CE



Item no.	Contents
80 10 00 12	

VOLTAGE TESTER

- ▶ 6-24V
- ▶ LED & buzzer indication
- ▶ CE



Item no.	Contents
80 10 00 13	3x116mm

CIRCUIT TESTER

- ▶ 6-24V
- ▶ With PVC handle
- ▶ With cable and clamp
- ▶ CE



Item no.	Contents
80 10 00 14	120mm

INSULATED TAPE

- ▶ Waterproof & fireproof material
- ▶ 0.13mmx19mmx10m
- ▶ Red, yellow, blue, white, green and black colors
- ▶ Skin card packing



Item no.	Contents
80 10 20 01	

175PCS CABLE TERMINAL SET

- ▶ 18 types of cable terminals
- ▶ Packed in transparent, plastic box with color card



Item no.	Contents
80 90 00 01	

300PCS CABLE TERMINAL SET

- ▶ 18 types of cable terminals
- ▶ Packed in transparent plastic box with color card



Item no.	Contents
80 90 00 02	

127PCS HEAT-SHRINKABLE WIRE WRAPASSORTMENT SET

- ▶ UL/CSA certificate



Item no.	Contents
80 90 00 04	30pcs 2.0x40mm 25pcs 2.5x40mm 20pcs 3.5x40mm 20pcs 5.0x40mm 16pcs 7.0x80mm 8pcs 10x80mm 8pcs 13x85mm

1000V INSULATED PLIER

- ▶ Combination pliers,
- ▶ Diagonal cutters,
- ▶ Long nose pliers



Item no.	Contents
80 30 20 01	

COMBINATION PLIERS

- ▶ VDE/GS approved
- ▶ EN60900 insulated standard
- ▶ ISO standard.
- ▶ 50CRV steel material
- ▶ Polished finish
- ▶ 2 colors TPE handle



Item no.	Size
80 30 10 01	A/B/C 6"
80 30 10 02	A/B/C 7"
80 30 10 03	A/B/C 8"

LONG NOSE PLIERS



Item no.	Size
80 30 10 04	A/B/C 6"
80 30 10 05	B 7"
80 30 10 06	A/B/C 8"

LONG NOSE PLIERS

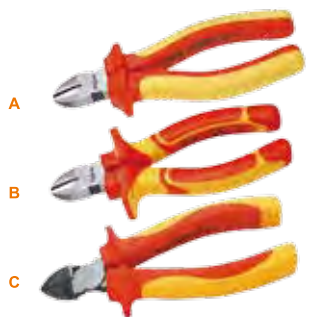

Item no.	Size
80 30 10 07	A/B/C 6"

BIG HEAD DIAGONAL CUTTERS



Item no. Size

80 30 10 08	A/B/C	7"
80 30 10 09	B	8"

BENT NOSE PLIERS



Item no. Size

80 30 10 10	A/B/C	6"
80 30 10 11	B	7"
80 30 10 12	A/B/C	8"

WIRE STRIPPERS

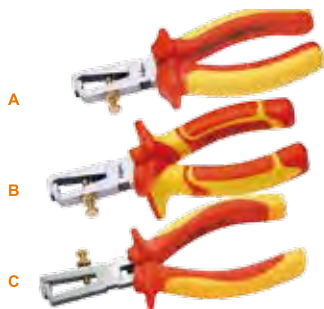

Item no. Size

80 30 10 13	A/B/C	6"
-------------	-------	----

ROUND NOSE PLIERS



Item no. Size

80 30 10 14	A/B/C	6"
-------------	-------	----

FLAT NOSE PLIERS



Item no. Size

80 30 10 15	B/C	6"
-------------	-----	----

BIG HEAD COMBINATION PLIERS



Item no. Size

80 30 10 16	B/C	6"/7"/8"
-------------	-----	----------

CABLE CUTTERS



Item no. Size

80 30 10 17	6"
-------------	----

WATER PUMP PLIERS



Item no. Size

80 30 10 18	10"
-------------	-----

VDE SCREWDRIVER

- ▶ VDE/GS approved
- ▶ EN60900 insulated standard
- ▶ ISO standard.
- ▶ #60Cr-Mo steel with heat treatment
- ▶ Hardness: HRC58-60
- ▶ Chrome plated blade with black tips with magnetic
- ▶ PE plastic coated blade
- ▶ 2 colors TPE handle



Item no. Contents

80 30 30 01	SL0.4x2.5x75
80 30 30 02	SL0.6x3x100
80 30 30 03	SL0.8x4x100
80 30 30 04	SL1.0x5.5x125
80 30 30 05	SL1.2x6.5x150
80 30 30 06	SL1.6x8x175
80 30 30 07	SLPH0x3x60
80 30 30 08	PH1x4.5x80
80 30 30 09	PH2x6x100
80 30 30 10	PH3x8x150
80 30 30 11	PZ0x3x60
80 30 30 12	PZ1x4.5x80
80 30 30 13	PZ2x6x100
80 30 30 14	PZ3x8x150
80 30 30 15	PH0x3x100
80 30 30 16	PH1x4.5x150
80 30 30 17	PH2x6x175
80 30 30 18	PH3x8x200
80 30 30 19	PZ0x3x100
80 30 30 20	PZ1x4.5x150
80 30 30 21	PZ2x6x175
80 30 30 22	PZ3x8x200

VDE SCREWDRIVER

- ▶ Cr-v steel with heat treatment,
- ▶ Chrome plated blade with black tips,
- ▶ With magnetic tips,
- ▶ Plastic blade cover,
- ▶ 2 colors TPR handle



Item no. Contents

80 30 30 23	SL3x75
80 30 30 24	SL4x100
80 30 30 25	SL5.5x125
80 30 30 26	SL6.5x150
80 30 30 27	SL8x175
80 30 30 28	PH0x75
80 30 30 29	PH1x80
80 30 30 30	PH2x100
80 30 30 31	PH3x150
80 30 30 32	PZ1x80
80 30 30 33	PZ2x100
80 30 30 34	PZ3x150

VDE SCREWDRIVERS

- ▶ VDE/GS approved
- ▶ EN60900 insulated standard
- ▶ ISO standard.
- ▶ #Cr-v steel with heat treatment
- ▶ Chrome plated blade with black tips with magnetic
- ▶ PE plastic coated blade
- ▶ 2 colors TPR handle



Item no. Contents

80 30 30 35	SL3x75mm
80 30 30 36	SL4x100mm
80 30 30 37	SL5.5x125mm
80 30 30 38	SL6.5x150mm
80 30 30 39	SL8x175mm
80 30 30 40	PH0x60mm
80 30 30 41	PH1x80mm
80 30 30 42	PH2x100mm
80 30 30 43	PH3x150mm
80 30 30 44	PZ0x60mm
80 30 30 45	PZ1x80mm
80 30 30 46	PZ2x100mm
80 30 30 47	PZ3x150mm

VDE SCREWDRIVER

- ▶ VDE/GS approved
- ▶ EN60900 insulated standard
- ▶ ISO standard.
- ▶ #60Cr-Mo steel with heat treatment
- ▶ Hardness: HRC58-60
- ▶ Chrome plated blade with black tips with magnetic
- ▶ PE plastic coated blade
- ▶ 2 colors TPE handle



Item no. Contents

80 30 30 01	SL0.4x2.5x75
80 30 30 02	SL0.6x3x100
80 30 30 03	SL0.8x4x100
80 30 30 04	SL1.0x5.5x125
80 30 30 05	SL1.2x6.5x150
80 30 30 06	SL1.6x8x175
80 30 30 07	SLPH0x3x60
80 30 30 08	PH1x4.5x80
80 30 30 09	PH2x6x100
80 30 30 10	PH3x8x150
80 30 30 11	PZ0x3x60
80 30 30 12	PZ1x4.5x80
80 30 30 13	PZ2x6x100
80 30 30 14	PZ3x8x150
80 30 30 15	PH0x3x100
80 30 30 16	PH1x4.5x150
80 30 30 17	PH2x6x175
80 30 30 18	PH3x8x200
80 30 30 19	PZ0x3x100
80 30 30 20	PZ1x4.5x150
80 30 30 21	PZ2x6x175
80 30 30 22	PZ3x8x200

7-PCS INSULATED SCREWDRIVER SET

- ▶ All screwdrivers with gs-approval,
- ▶ Blades made of cr-v, hardened tips,
- ▶ Per set in window-colorbox,
- ▶ Packing unit: 10 sets/export carton



Item no. Contents

80 90 00 05	SCREWDRIVER (+) PH1X80,PH2X100 (-)0.5X3.0X100, 0.8X4.0X100, 1.0X5.5X125, 1.2X6.5X15 1 PC. ELECTRIC TESTER 100-250V (WITH 1 M-OHM RESISTOR)
-------------	-----------------------------------------------------------------------------------------------------------------------------------------------------------

7-PCS INSULATED SCREWDRIVER SET

- ▶ All screwdrivers with GS-approval,
- ▶ Blades made of cr-v, hardened tips,
- ▶ Per set in window-colorbox,
- ▶ Packing unit: 10 sets/export carton



Item no. Contents

80 90 00 06	SCREWDRIVER (+) PH0X60,PH1X80,PH2X100 (-)0.5X3.0X100, 0.8X4.0X100, 1.0X5.5X125, 1.2X6.5X150
-------------	----------------------------------------------------------------------------------------------------------

8PCS VDE SCREWDRIVER SET



Item no. Contents

80 90 00 07	Slotted screwdriver: 0.5x3x100 0.8x4x100 1x5.5x125 1.2x6.5x150 Phillips screwdriver: PH0x60 PH1x80 PH2x100 140mm voltage tester
-------------	------------------------------------------------------------------------------------------------------------------------------------------------------------

2PCS VDE SCREWDRIVER SET



Item no.	Contents
80 90 00 08	Phillips screwdriver: PH0*60MM 140mm voltage tester

2PCS VDE SCREWDRIVER SET



Item no.	Contents
80 90 00 11	Phillips screwdriver: PH0*75MM 140mm voltage tester

4PCS VDE TOOL SET



Item no.	Contents
80 90 00 14	6" long nose plier 6" wire stripper 6" diagonal cutter 6" combination plier

5PCS VDE SCREWDRIVER SET



Item no.	Contents
80 90 00 09	Phillips screwdriver: PH0x60MM;PH1x80 Slotted screwdriver: 3x100;5.5x125 140mm voltage tester

5PCS VDE SCREWDRIVER SET



Item no.	Contents
80 90 00 12	Phillips screwdriver: PH0*75MM PH1*80MM Slotted screwdriver: 4*100MM 5.5*125MM 140mm voltage tester

6PCS VDE TOOL SET



Item no.	Contents
80 90 00 15	6" wire stripper 6" combination plier slotted screwdriver: 3x100 4x100 Phillips screwdriver: PH1x80 PH2x100

7PCS VDE SCREWDRIVER SET



Item no.	Contents
80 90 00 10	Phillips screwdriver: PH0x60MM PH1x80 PH2x100 Slotted screwdriver: 3x100 5.5x125 6.5x150 140mm voltage tester

7PCS VDE SCREWDRIVER SET



Item no.	Contents
80 90 00 13	Phillips screwdriver: PH0x75MM PH1x80MM PH2x100MM Slotted screwdriver: 4x100MM 5.5x125MM 6.5x150MM 140mm voltage tester

7PCS VDE TOOL SET



Item no.	Contents
80 90 00 16	wire stripper 6" diagonal cutter 6" combination plier Slotted screwdriver: 3x100 4x100 Phillips screwdriver: PH1x80 PH2x100

5PCS VDE TOOLS SET

► Color box with window packing



Item no.	Contents
80 90 00 17	8"long nose plier 7"combination plier slotted screwdriver: 0.8x4x100mm 1.0x5.5x125mm Phillips screwdriver: PH2x6x100mm

6PCS VDE TOOLS SET



Item no.	Contents
80 90 00 18	6" diagonal cutter 6" combination plier 8" long nose plier Slotted screwdriver 4x100 Phillips screwdriver PH2x100 190mm voltage tester

11PCS VDE TOOLS SET



Item no.	Contents
80 90 00 19	6"long nose plier 6"diagonal cutter 6"wire stripper Slotted screwdriver: 3x100; 4x100; 5.5x125 190mm VDE Voltage tester VDE red & black color insulated tape

11PCS VDE TOOLS SET



Item no.	Contents
80 90 00 20	6"diagonal cutter 6"combination plier 6"long nose plier Slotted screwdriver: 3x75; 4x100; 5.5x125; 6.5x150 Phillips screwdriver: PH0x75; PH1x80; PH2x100 140mm voltage tester

8PCS VDE TOOL SET



Item no.	Contents
80 90 00 21	6"diagonal cutter 7"combination plier 8" long nose plier Slotted screwdriver: 4x100, 5.5x125 Phillips screwdriver: PH1x80, PH2x100 140mm VDE voltage tester

8PCS VDE TOOL SET



Item no.	Contents
80 90 00 22	8" long nose pliers 7" combination pliers 6" diagonal cutters Slotted screwdriver: 3x75/4x100 Pozi screwdriver: PH1x80/PH2x100 Voltage tester

9PCS VDE TOOL SET



Item no.	Contents
80 90 00 23	6" diagonal cutter 6" combination plier 6" long nose plier Slotted screwdriver: 3x75/4x100 Phillips screwdriver: PH1x80/PH2x100 Pozi screwdriver: PZ1x80 Insulated tape

7PCS VDE TOOL SET



Item no.	Contents
80 90 00 24	6" diagonal cutter 6" combination plier 6" long nose plier 10" #D4 water pump plier Slotted screwdriver: 4x100 Phillips screwdriver: PH1x80 Voltage teste

6PCS INSULATED TOOL SET



Item no.	Contents
80 90 00 25	8" combination plier 8" long nose plier 8" big head diagonal cutter Slotted screwdriver: 5.5x125 Phillips screwdriver: PH2x100 Pozi screwdriver: PZ2x100



9PCS PROFESSIONAL PRESENTATION TOOL KIT



Item no.	Contents
80 90 00 26	9pcs Hex key set, plastic holder 1pcs 6" VDE long nose pliers 1pcs 4 IN 1 screwdriver 1pcs VDE voltage tester 1pcs 6" adjustable wrench 1pcs professional universal aluminum cutter 10pcs spare blades 1pcs saw blade 1pcs stainless steel electrician's scissors

9PCS PROFESSIONAL PRESENTATION TOOL KIT



Item no.	Contents
80 90 00 28	1pcs measuring tape, 3.5M 1pcs 8OZ claw hammer 1pcs 6" VDE long nose pliers 2pcs VDE screwdrivers: 0.8x4x100mm PH1x4.5x80mm 1pcs VDE voltage tester 1pcs LED flashlight 1pcs professional universal aluminum cutter 10pcs spare blades

10PCS PROFESSIONAL PRESENTATION TOOL KIT



Item no.	Contents
80 90 00 27	8pcs Hex key set, ball point, with aluminum holder 1pcs 6" VDE long nose pliers 2pcs VDE screwdrivers: 0.8x4x100mm PH1x4.5x80mm 1pcs VDE voltage tester 1pcs 6" adjustable wrench 1pcs professional universal aluminum cutter 10pcs spare blades 1pcs LED flashlight 1pcs stainless steel electrician's scissors

9PCS PROFESSIONAL PRESENTATION TOOL KIT



Item no.	Contents
80 90 00 29	1pcs measuring tape, 3M 1pcs 6" adjustable wrench 1pcs 6" VDE long nose pliers 2pcs VDE screwdrivers: 0.8x4x100mm PH1x4.5x80mm 1pcs 2 IN 1 voltage tester 1pcs LED flashlight 1pcs professional universal aluminum cutter 10pcs spare blades

EXTENSION LEAD

- ▶ Outdoor extension cords/ 2 wire
- ▶ 18AWG/2C 16AWG/2C
- ▶ 127V, 60Hz 13A 60°C
- ▶ American standard



Item no.	Contents
80 20 20 01	

EXTENSION LEAD

- ▶ 16AWG/3C 14AWG/3C 12AWG/3C
- ▶ American standard



Item no.	Contents
80 20 20 02	

EXTENSION LEAD

- ▶ 16AWG/3C 14AWG/3C 12AWG/3C
- ▶ American standard



Item no.	Contents
80 20 20 03	

EXTENSION LEAD

- ▶ Outdoor extension cords 3 Outlet
- ▶ 16AWG/3C 14AWG/3C 12AWG/3C
- ▶ American standard



Item no.	Contents
80 20 20 04	

EXTENSION LEAD

- ▶ Indoor extension cords
- ▶ 16AWG/2C 13A 125V 1625W UL
- ▶ 6ft/9ft/12ft/15ft/20ft
- ▶ American standard



Item no. Contents

80 20 20 05

MINI REMOTE CONTROL SWITCH

- ▶ 1pc control can be applied to 5pcs socket
- ▶ 1150/3680watt
- ▶ GS/CE approval



Item no. Contents

80 99 00 01

ENERGY METER

- ▶ LCD display
- ▶ Rechargeable LI-battery
- ▶ Rating voltage: 230V, 50/60HZ
- ▶ Operating voltage: 200-250V
- ▶ Max current: 10A
- ▶ Energy display: 0kwh-999.9kwh
- ▶ Max record time: 999.9hours



Item no. Contents

80 99 00 02

EXTENSION SOCKET



Item no. Contents

80 20 40 03



SPOT LIGHT

- ▶ 1000, 000 candle;
- ▶ Swivel handle and stand;
- ▶ Equipped with a 6V 4Ah sealed lead acid battery and a AV/ DC battery charger;
- ▶ Weather proof construction ;
- ▶ Using automobile cigarette lighter plug for charging (included);
- ▶ Camping, fishing, hunting & outdoors use



Item no.	Contents
85 20 40 01	

SPOT LIGHT

- ▶ Made of ABS,
- ▶ Battery type: 6V4AH,
- ▶ Bulb: 6W4AH, 700000/1000000 candle power;
- ▶ Color box packing



Item no.	Contents
85 20 40 04	

3 IN 1 LED SPOT LIGHT

- ▶ Three kind of illumination:
- ▶ 1. Press the switch on "I": light halogen bulb
- ▶ 2. Press the switch on "II", light 9 LED, work for 6-8hours, energy saving
- ▶ 3. Press another switch, light and fluorescent lamp
- ▶ battery: lead-acid rechargeable battery 6V 4AH
- ▶ with AC adaptor and 12V DC charger



Item no.	Contents
85 20 40 07	

SPOT LIGHT

- ▶ 1500, 000 candle;
- ▶ Swivel handle and stand
- ▶ Equipped with a 6V 4Ah sealed lead acid battery and a AV/ DC battery charger;
- ▶ Weather proof construction ;
- ▶ Using automobile cigarette lighter plug for charging (included);
- ▶ Camping, fishing, hunting & outdoors use



Item no.	Contents
85 20 40 02	

LED SPOT LIGHT

- ▶ Super bright 12pcs LED
- ▶ Built in 4V/2AH rechargeable battery
- ▶ Luminotron display while charging
- ▶ Discharge time:15hours
- ▶ One touch switch design
- ▶ AC Adapter:UL/GS
- ▶ Material: ABS/PVC
- ▶ Include AC adapter and DC adapter for charge



Item no.	Contents
85 20 40 05	

PLASTIC SPOT LIGHT

- ▶ Material:ABS
- ▶ Bulb type:4.8V/0.5A
- ▶ Battery:4xD
- ▶ Burn time: 5H
- ▶ Water proof level: IP44



Item no.	Contents
85 20 40 09	

SPOT LIGHT

- ▶ 1M to 2M CP rechargeable spotlight
- ▶ powerful 6V 25W halogen bulb
- ▶ 6V 4AH rechargeable battery(CE)
- ▶ Including AC-DC adaptor(GS. UL. BS.CE)
- ▶ and DC 12V car charger



Item no.	Contents
85 20 40 03	

LED SPOT LIGHT

- ▶ 500,000/1,000,000CP
- ▶ 19pcs LED rechargeable spotlight
- ▶ 6V 4AH lead-acid battery
- ▶ AC-DC adaptor
- ▶ DC 12V car plug



Item no.	Contents
85 20 40 06	

CAMPING LANTERN

- ▶ 4 LED
- ▶ 4x"AAA" battery(not included)



Item no.	Contents
85 20 40 10	

CAMPING LANTERN

- ▶ 7W*U tube
- ▶ 4x"D" battery(not included)



Item no.	Contents
85 20 40 11	

CAMPING LANTERN

- ▶ Super bright fluorescent U-tube: 7W Built in 6V/4Ah rechargeable battery
- ▶ Discharge time: 7W(6hours) Waterproof Handy carrying handle ;
- ▶ Operate manually or by remote control
- ▶ With infrared remote(effective range:8m)
- ▶ Different colors are available



Item no.	Contents
85 20 40 13	

KEROSENE LANTERNS

- ▶ 4 LED
- ▶ 4x"AAA" battery(not included)



Item no.	Contents
85 99 00 01	

CAMPING LANTERN

- ▶ 20LED
- ▶ 4x"D" battery(not included)
- ▶ Infrared remote control



Item no.	Contents
85 20 40 12	

DYNAMO/CHARGER CAMPING LANTERN

- ▶ 12LED
- ▶ Lantern with hand crank dynamo
- ▶ 3xAA 800MAH 3.6v
- ▶ With carry handle and hanger hook



Item no.	Contents
85 20 40 14	

TENT LIGHT

- ▶ 24LED
- ▶ 4xAA batteries



Item no.	Contents
85 20 40 17	

TENT LIGHT

- ▶ Super bright 5pcs LED
- ▶ Use 4x"AAA"size batteries
- ▶ Discharge time:8 hours
- ▶ Operate manually or by remote control
- ▶ With infrared remote(effective range:8m)
- ▶ With hanging chassis
- ▶ With magnet board
- ▶ Main material:ABS/PS



Item no.	Contents
85 20 40 18	

SOLAR RECHARGEABLE LANTERN

- ▶ 12LED Solarpanel max power:110ma
- ▶ Voltage at max power:4.2v
- ▶ 3xAA 800MAH 3.6v



Item no.	Contents
85 20 40 15	



PLASTIC TORCH

- ▶ 1 bulb torch:
- ▶ 2xD
- ▶ 2xAAA
- ▶ 1xAAA



Item no.	Contents
85 10 00 01	

8 LED FLASHLIGHT

- ▶ Push on/off button at the end of flashlight, Handy carrying strap; Φ22.2x100mm; Use 1 xAA Batteries



Item no.	Contents
85 10 00 08	

1W FLASHLIGHT

- ▶ Battery:3xAAA
- ▶ Lumens:60
- ▶ Product size:D33.5x110MM
- ▶ Working time:8H
- ▶ Waterproof:IP62



Item no.	Contents
85 10 00 11	

3 LED FLASHLIGHT

- ▶ 2xAAA/12Lu/D40x142/16H/IP62
- ▶ 2xD/12Lu/D70x208/40H/IP62
- ▶ 3xD/12Lu/D70x249/60H/IP62



Item no.	Contents
85 10 00 02	

9 LED FLASHLIGHT

- ▶ Push on/off button at the end of flashlight, Handy carrying strap; Φ30x100mm; Use 3xAAA Batteries



Item no.	Contents
85 10 00 09	

3W FLASHLIGHT

- ▶ Battery:3xAAA
- ▶ Bulb:3W(CREE) LED
- ▶ Lumens:120
- ▶ Product size:D36x141.5MM
- ▶ Working time:3.5H
- ▶ Waterproof:IP67



Item no.	Contents
85 10 00 12	

5 LED FLASHLIGHT

- ▶ Switch on/off by rotation; Handy carrying strap; Φ20.2x88mm; use 1xAA Batteries



Item no.	Contents
85 10 00 06	

5 LED FLASHLIGHT

- ▶ Battery3xAAA
- ▶ Lumens:56
- ▶ Size:D39x101MM
- ▶ Working Time:8H
- ▶ Waterproof:IP67



Item no.	Contents
85 10 00 10	

ALUMINIUM LED HAND TORCH WITH 10 HIGH INTENSITY LEDS

- ▶ Extensive lifetime of LED(100,000hrs)
- ▶ Ultra bright LED light
- ▶ Aluminium & rubber body
- ▶ Handy carrying strap (included)
- ▶ HIGH INTENSITY LEDS; BEST DESIGN
- ▶ WATER RESISTANT



Item no.	Contents
85 10 00 14	

LED/XENON

- ▶ Combination for super brightness and ultra-long run time.
- ▶ Computer-machined;
- ▶ Anodized aluminum;
- ▶ O-ring sealed;
- ▶ Adjustable focus;
- ▶ Micro-faceted reflector;
- ▶ 6LED+1 Xenon;
- ▶ μ 38x130mm
- ▶ use3 xAAA Batteries



Item no.	Contents
85 10 00 15	

LED FLASHLIGHT WITH 12V PLUG RECHARGER

- ▶ Rechargeable by cigarette lighter plug.
- ▶ Hard head can break the car window when emergency.



Item no.	Contents
85 10 30 01	

NIGHT INDICATOR LIGHT

- ▶ Material: ABS
- ▶ Bulb type:2.4V/0.75A krypton bulb
- ▶ Battery:2xD
- ▶ Burn time:5H



Item no.	Contents
85 10 30 09	

CORDLESS FLASHLIGHT

- ▶ Built-in rechargeable Nickel-Cadmium batteries
- ▶ Functional and useful
- ▶ With strong magnetic holder in the handle
- ▶ The operation time for a fully charged torch under constant discharge use is approx. 30-45 min



Item no.	Contents
85 10 30 02	

2 LED HAND-PRESSING FLASHLIGHT



Item no.	Contents
85 10 30 03	

SOLAR FLASHLIGHT



Item no.	Contents
85 10 30 05	

CRANK DYNAMO FLASHLIGHT



Item no.	Contents
85 10 30 06	

MINI LED FLASHLIGHT

- ▶ Aluminium body
- ▶ 3 LED



Item no.	Contents
85 10 00 17	

SOLAR FLASHLIGHT



Item no.	Contents
85 10 30 07	

SOLAR FLASHLIGHT



Item no.	Contents
85 10 30 08	

MINI LED FLASHLIGHT

- ▶ 1 LED; Use 3xAG3 Batteries; With key clip; Φ 15x67mm



Item no.	Contents
85 10 00 18	

MINI LED FLASHLIGHT

- ▶ 1 LED ; Use 4xAG3 Batteries; Colorful appearance; With key clip; Φ13.8x54mm



Item no.	Contents
85 10 00 19	

MINI LED GIFT LIGHT



Item no.	Contents
85 10 00 20	

MINI LED GIFT LIGHT



Item no.	Contents
85 10 00 21	

BICYCLE LIGHT

- ▶ 3xAA
- ▶ 3LED
- ▶ 10Lu
- ▶ D40x100MM
- ▶ 60H



Item no.	Contents
85 20 40 19	

HEAD LIGHT

- ▶ 3xAAA
- ▶ 1W
- ▶ 5Lu
- ▶ D42.5x93MM
- ▶ 30M/10H



Item no.	Contents
85 20 40 20	

HEAD LIGHT

- ▶ 3xAAA
- ▶ 7/10/12/14/18LED
- ▶ 25Lu
- ▶ D42.5x93MM
- ▶ 10M/14H



Item no.	Contents
85 20 40 21	

HEAD LIGHT

- ▶ 3xAAA
- ▶ 7/10/12/14/18+2LED
- ▶ 25Lu
- ▶ D42.5x93MM
- ▶ 10M/14H



Item no.	Contents
85 20 40 22	

HEAD LIGHT

- ▶ 3xAAA
- ▶ 8+2LED
- ▶ 25Lu
- ▶ D42.5x93MM
- ▶ 10M/14H



Item no.	Contents
85 20 40 23	

HAND LIGHT

- ▶ GS/CE-approval;
- ▶ Voltage: 220-240V, power: 8 W, power cable: 5 m with useful hang-up hook



Item no.	Contents
85 20 20 01	8W

FLUORESCENT WORKING LIGHT

- ▶ Voltage: 12V, power: 8 W
- ▶ With hanging hook



Item no.	Contents
85 20 40 24	

WORKING LAMP

- ▶ AC220-240V 50W
- ▶ 2x0.75mm² 5M cable



Item no.	Contents
85 20 20 02	

PORTABLE ELECTRIC HAND LAMP	
<ul style="list-style-type: none"> ▶ NOM standard ▶ SJTW 18AWG/3C 16AWG/3C ▶ Grounded and polarized plug and connectors, ▶ Portable electric hand lamp metallic cage 	
	
Item no.	Contents
85 20 20 03	

WORKING LIGHT	
<ul style="list-style-type: none"> ▶ With 45 LED, the same brightness as a 30 watt incandescent bulb. ▶ Material:aluminium ▶ Light output:9000-12000mcd ▶ Battery:3pcs AA alkaline battery(not included) ▶ Active life:3-4hours 	
	
Item no.	Contents
85 20 40 28	

WORKING LIGHT	
<ul style="list-style-type: none"> ▶ Shatterproof and shock resistant protective ▶ 24 super bright LED(1W) and 2 fluorescent lamps ▶ Luminance:about 335LM ▶ IP 54 ▶ Power cord:5m rubber 3x1.5mm2 	
	
	
Item no.	Contents
85 20 20 04	

12V WORKING LAMP	
<ul style="list-style-type: none"> ▶ Trouble light with plastic ▶ DC 12V/24V 50W 	
	
Item no.	Contents
85 20 40 25	

WORKING LIGHT	
<ul style="list-style-type: none"> ▶ With 27+9 LED ▶ With charger and cable connection to cigarette lighter (12V); ▶ With useful hang-up hook; ▶ Color box or double blister packing 	
	
Item no.	Contents
85 20 40 29	

MOBILE WORKING LIGHT	
<ul style="list-style-type: none"> ▶ High light output – Low heat emission ▶ Low energy consumption ▶ Long Lamp Life of up to 5000 hours ▶ Up to 5 times as bright as conventional incandescent bulbs ▶ Even and wide distribution of light ▶ 3 switch settings:24w-36w-60w ▶ Robust and shock-resistant housing ▶ Adjustable galvanised steel tube frame with ergonomic handle ▶ 2 Earthing type sockets 15.5a 250v on the back side 	
	
	
Item no.	Contents
85 20 20 05	

LED WORKING LIGHT	
<ul style="list-style-type: none"> ▶ Swivel body ▶ Rechargeable working light ▶ 26 super white LED ▶ Discharging time:4-5hours ▶ Charging time:4 hours ▶ Charge and discharge protection ▶ Material: ABS rubber ▶ With magnet 	
	
Item no.	Contents
85 20 40 26	

WORK LIGHT WIYH MAGNETIC	
<ul style="list-style-type: none"> ▶ 12V ▶ 3W bulb ▶ 3.5M cable 	
	
Item no.	Contents
85 20 40 30	

RECHARGEABLE TELESCOPIC WORK LIGHT	
<ul style="list-style-type: none"> ▶ With 30 super white LED and 1W super white LED on top of the lamp ▶ Luminance:about 12,000MCD ▶ Battery:3.7V 1600 MAH-L1 battery ▶ Lifetime of LED is rated up to 100,000 hours ▶ Discharging time:4hours ▶ Charging voltage:DC12V 500mA ▶ Charging time:4 hours ▶ Wattage:2 W 	
	
Item no.	Contents
85 20 40 27	

WORK LIGHT WIYH MAGNETIC	
<ul style="list-style-type: none"> ▶ 12V ▶ 10W bulb ▶ 3m cable 	
	
Item no.	Contents
85 20 40 31	

HALOGEN LAMP	
<ul style="list-style-type: none"> ▶ Two piece frame construction with tilt and lock facility. ▶ Weatherproof. Suitable for external use. ▶ Supplied completed with 150W or 500W halogen bulb and fitted with a metal grill to protect lens/bulb from damage and protect users hand from hot lens. ▶ With VDE approval cable and plug. 	
	
Item no.	Contents
85 20 20 06	

HALOGEN LAMP

- ▶ Two piece frame construction with tilt and lock facility.
- ▶ Weatherproof. Suitable for external use.
- ▶ Supplied completed with 150W or 500W halogen bulb and fitted with a metal grill to protect lens/bulb from damage and protect users hand from hot lens.
- ▶ With VDE approval cable and plug.



Item no.	Contents
85 20 20 07	150W
85 20 20 08	500W

127 LED ENERGY LIGHT

- ▶ Diffuser and casing of impact resistant polycarbonate
- ▶ 1 socket 230V in the back
- ▶ adjustable arm
- ▶ 230V,
- ▶ 127LED , 16cd white
- ▶ Cable 3x1.5mm², 5m(rubber)



Item no.	Contents
85 20 20 11	

4U ENERGY SAVING LAMP

- ▶ 110/230V/50/60Hz/2700K-6400K/8000 hours life



Item no.	Contents(w)
85 50 60 17	35
85 50 60 18	38
85 50 60 19	45
85 50 60 20	65
85 50 60 21	85

HALOGEN LAMP WITH STANDS

- ▶ Twist lock for quick & easy height adjustment
- ▶ Stands folds away for easy storage
- ▶ Fast, easy lock-pin mechanism
- ▶ For tripod legs



Item no.	Contents
85 20 20 09	

2U ENERGY SAVING LAMP

- ▶ 110/230V/50/60Hz/2700K-6400K/8000 hours life
- ▶ E14/E27/B22 lamp head



Item no.	Contents(w)
85 50 60 01	5
85 50 60 02	7
85 50 60 03	9
85 50 60 04	13
85 50 60 05	15
85 50 60 06	18

6U ENERGY SAVING LAMP

- ▶ 110/230V/50/60Hz/2700K-6400K/8000 hours life
- ▶ E27/E40 lamp head



Item no.	Contents(w)
85 50 60 22	105
85 50 60 23	125
85 50 60 24	150

108 LED ENERGY LAMP

- ▶ With 108 super white LED
- ▶ Luminance: about 95 LM
- ▶ Power cord:2x0.75mm²
- ▶ Lifetime of LED is rated up to 100,000hours
- ▶ Input voltage:110V-230V
- ▶ Input electricity:60mA
- ▶ Wattage:13.8W



Item no.	Contents
85 20 20 10	

3U ENERGY SAVING LAMP

- ▶ 110/230V/50/60Hz/2700K-6400K/8000 hours life
- ▶ E27/B22 lamp head



Item no.	Contents(w)
85 50 60 07	7
85 50 60 08	9
85 50 60 09	11
85 50 60 10	13
85 50 60 11	15
85 50 60 12	18
85 50 60 13	20
85 50 60 14	23
85 50 60 15	26
85 50 60 16	28

HALF SPIRAL LAMP

- ▶ 110/230V/50/60Hz/2700K-6400K/8000 hours life
- ▶ E27/B22/E40 lamp head



Item no.	Contents(w)
85 50 60 28	5
85 50 60 29	7
85 50 60 30	9
85 50 60 31	13
85 50 60 32	15
85 50 60 33	18
85 50 60 34	20
85 50 60 35	23
85 50 60 36	26
85 50 60 37	28
85 50 60 38	35
85 50 60 39	45
85 50 60 40	65
85 50 60 41	85
85 50 60 42	105
85 50 60 43	125
85 50 60 44	145

FULL SPIRAL ENERGY SAVING LAMP

- ▶ 110/230V/50/60Hz/2700K-6400K/8000 hours life
- ▶ E14/E27/B22/E40 lamp head



Item no. Contents(w)

85 50 60 45	5
85 50 60 46	7
85 50 60 47	9
85 50 60 48	13
85 50 60 49	15
85 50 60 50	18
85 50 60 51	20
85 50 60 52	23
85 50 60 53	26
85 50 60 54	28
85 50 60 55	35
85 50 60 56	45
85 50 60 57	65
85 50 60 58	85
85 50 60 59	105
85 50 60 60	125
85 50 60 61	145

UMBRELLA ENERGY SAVING LAMP

- ▶ 110/230V/50/60Hz/2700K-6400K/8000 hours life
- ▶ E27/B22 lamp head



Item no. Contents(w)

85 50 60 62	10
85 50 60 63	15
85 50 60 64	20
85 50 60 65	28
85 50 60 66	45
85 50 60 67	65

GLOBAL LAMP

- ▶ 110/230V/50/60Hz/2700K-6400K/8000 hours life
- ▶ E27/B22 lamp head



Item no. Contents(w)

85 50 60 68	7
85 50 60 69	9
85 50 60 70	11
85 50 60 71	13
85 50 60 72	15
85 50 60 73	18
85 50 60 74	20
85 50 60 75	23

PLUGGABLE 2U ENERGY SAVING LAMP

- ▶ 110/230V/50/60Hz/2700K-6400K/8000 hours life
- ▶ G 24d lamp head



Item no. Contents(w)

85 50 60 76	9
85 50 60 77	13
85 50 60 78	18

PLUGGABLE H ENERGY SAVING LAMP

- ▶ 110/230V/50/60Hz/2700K-6400K/8000 hours life
- ▶ 2G11 lamp head



Item no. Contents(w)

85 50 60 79	24
85 50 60 80	36
85 50 60 81	55

STERILIZING LAMP

- ▶ 110/230V/50/60Hz/2700K-6400K/8000 hours life
- ▶ E27/B22 lamp head



Item no. Contents(w)

85 99 00 03	5
85 99 00 04	7
85 99 00 05	9
85 99 00 06	11
85 99 00 07	13
85 99 00 08	15

MOSQUITO EJECTED LAMP

- ▶ 110/230V/50/60Hz/2700K-6400K/8000 hours life
- ▶ E27/B22 lamp head



Item no. Contents(w)

85 99 00 09	13
85 99 00 10	15
85 99 00 11	18
85 99 00 12	20
85 99 00 13	23
85 99 00 14	25

CIRCULAR LAMP

- ▶ 110/230V/50/60Hz/2700K-6400K/8000 hours life
- ▶ E27/B22 lamp head



Item no. Contents(w)

85 50 80 01	22
85 50 80 02	32

FLUORESCENT LAMP

- ▶ 110/230V/50/60Hz/2700K-6400K/8000 hours life
- ▶ G13 lamp head



Item no. Contents(w)

85 50 80 03	10
85 50 80 04	20
85 50 80 05	30
85 50 80 06	40



MINI GRINDER SET



Item no.	Contents
87 90 00 01	1pc Grinding/Engraving application Infinitely adjustable speed range 12000-23000 r.p.m, noise<75dB, with hanging hook 1pc GS/CE/EMS-approval, power plug 18V/1000MA 1pc screwdriver 4pcs clamping chucks Φ0.8mm/Φ1.2mm/Φ1.8mm/Φ2.3mm 6pcs HSS drills Φ0.8/Φ1.0/Φ1.2/Φ1.4/Φ1.6/Φ1.8 5pcs grinding stone 4pcs milling cutter 3pcs brushes 2pcs reception devices for mini grinding and cutting disc 2pcs mini grinding discs normal 2pcs mini grinding discs 10pcs mini cutting discs 1pc polishing felt

MINI GRINDER SET



Item no.	Contents
87 90 00 02	TUV/GS+CE+EMC-approval, 130W/230V/50HZ, Infinitely adjustable speed range 8000-30000 r.p.m. with hanging hook 8000-30000RPM 2.0M VDE approval H0.5VV-F2X0.75MM ² cable 10/16A/250V plug 1pc flexible axis 1.1m 1pc stand

MINI GRINDER SET



Item no.	Contents
87 90 00 03	TUV/GS+CE+EMC-approval, 130W/230V/50HZ, Infinitely adjustable speed range 8000-30000 r.p.m. 2.0M VDE approval H0.5VV-F2X0.75MM ² cable 10/16A/250V plug 1pc flexible axis 1.2m 1pc flexible axis 1.3m 2.0M VDE approval H0.5VV-F2X0.75MM ² cable 10/16A/250V plug

ELECTRICAL SPRAY GUN

- ▶ TUV/GS,CE approval
- ▶ with 3mmX11M wire rope. With urgent stop switch & reinforced breaking switch with position limit
- ▶ protection class up to IP54
- ▶ with thermal prevention device
- ▶ VDE cable
- ▶ Voltage: 220/230V,
- ▶ Power: 500Watts,
- ▶ Rated lifting weight: 125-250kg
- ▶ lifting height: 12/6m
- ▶ lifting speed: 8/4 m/min



Item no.	Contents
87 99 00 01	

ELECTRICAL SPRAY GUN

- ▶ TUV/GS/EMC-approval
- ▶ Rated Voltage:220V-240V/110V
- ▶ Frequency: 50/60Hz
- ▶ Rated Rated Input Power:45 W
- ▶ Capacity 200ml/min
- ▶ Bottle capacity:600 ml



Item no.	Contents
87 10 00 01	

ELECTRICAL SPRAY GUN

- ▶ TUV/GS/EMC-approval
- ▶ Rated Voltage:220V-240V/110V
- ▶ Frequency: 50/60Hz
- ▶ Rated Rated Input Power:100 W
- ▶ Capacity: 300ml/min
- ▶ Bottle capacity: 600/900 ml



Item no.	Contents
87 10 00 02	

CAR POLISHER

- ▶ TUV/GS/EMC-approval
- ▶ Voltage:230V / 50Hz
- ▶ Power:120W
- ▶ Polisher head dia.240mm
- ▶ No-load speed: 3000 R.P.M.
- ▶ With 2M cable
- ▶ With 2pcs covers



Item no.	Contents
87 40 40 01	

MULTI-FUNCTION RECHARGEABLE SCREWDRIVER

- ▶ 3.6/4.8/2.4V with LED light, turnable handle
- ▶ Forward/reverse, speed 150RPM
- ▶ Charge time:3-5H
- ▶ Power plug, GS-approval



Item no.	Contents
87 45 00 03	4.8V

26PCS ELECTRICAL SCREWDRIVER SET



Item no.	Contents
87 90 00 06	1pc Foldable 3.6/4.8V screwdriver, 16 torque setting, Max:2.5Nm with LED light 18pcs 25mm bits 2pcs 50mm bit 3pcs HSS drill 1pc bits holder 1pc 3-5 hours charger

RECHARGEABLE SCREWDRIVER

- ▶ 3.6/4.8V
- ▶ Forward/reverse, speed 150RPM
- ▶ Charge time:3-5H
- ▶ Power plug, GS-approval



Item no.	Contents
87 45 00 01	4.8V

MULTI-FUNCTION RECHARGEABLE CHUCK

- ▶ Apply for electric screwdriver and drill
- ▶ With 4pcs screwdriver PH1,PH2,SL4,SL6,2pcs HSS drill Φ3.2,Φ4



Item no.	Contents
87 80 20 01	

41PCS ELECTRICAL SCREWDRIVER SET



Item no.	Contents
87 90 00 07	1pc Foldable 3.6/4.8V screwdriver, 23 torque setting, Max:2.5Nm 28pcs bits 8pcs sockets 1pc bit holder 1pc sockets holder 1pc 5-7 hours charges 1pc charge base

RECHARGEABLE SCREWDRIVER

- ▶ 3.6/2.4V,with turnable handle
- ▶ Forward/reverse, speed 250RPM
- ▶ Charge time:3-5H
- ▶ Power plug, GS-approval



Item no.	Contents
87 45 00 02	3.6V

17PCS ELECTRICAL SCREWDRIVER SET



Item no.	Contents
87 90 00 05	1pc 3.6V/4.8V screwdriver with LED battery level indicator and spindle lock 15pcs 25mm bits 1pc 3-5 hours charger

CORDLESS DRILL

- ▶ Voltage: 14.4V/18V/21.6V
- ▶ No-load speed:0-350rpm /0-1250rpm
- ▶ Chuck:1-10MM
- ▶ Torque: 24 Torque setting Max: 20Nm
- ▶ With LCD and LED light



Item no.	Contents
87 15 00 01	



CORDLESS DRILL

- ▶ Voltage: 7.2V-18V
- ▶ No-load speed:0-550rpm
- ▶ Chuck:1-10MM
- ▶ Torque: 16+1 Torque setting:8-10 Nm
- ▶ with impact function



Item no.	Contents
87 15 00 02	

CORDLESS DRILL

- ▶ Voltage: 18V
- ▶ No-load speed:0-400/0-1150min-1
- ▶ Chuck:0.8-10MM
- ▶ Torque:16+1
- ▶ Charger:3-5hours



Item no.	Contents
87 90 00 10	

ELECTRIC TIRE WRENCH

- ▶ GS/CE/EMC/E-MARK/ROHS/PAHS
- ▶ Output DR. 1/2"
- ▶ Max torque: 380nN.m/271Ft.Lb
- ▶ No load speed: 5000rpm
- ▶ Voltage: DC12V
- ▶ Max current: 8A



Item no.	Contents
87 30 00 01	

CORDLESS DRILL

- ▶ Voltage: 20.4V-24V
- ▶ No-load speed:0-900rpm
- ▶ Chuck:2-13MM
- ▶ Torque: 16+1 torque setting:10 -12Nm
- ▶ With impact function



Item no.	Contents
87 15 00 03	

CORDLESS DRILL

- ▶ Voltage: 18V
- ▶ No-load speed:0-400/0-1150min-1
- ▶ Chuck:0.8-10MM
- ▶ Torque:23+1
- ▶ Quick charger: 1hours



Item no.	Contents
87 90 00 11	

ELECTRIC TIRE WRENCH

- ▶ GS/CE/EMC/E-MARK/ROHS/PAHS
- ▶ Output DR. 1/2"
- ▶ Max torque: 380nN.m/271Ft.Lb
- ▶ No load speed: 5000rpm
- ▶ Voltage: DC12V
- ▶ Max current: 8A



Item no.	Contents
87 30 00 02	

CORDLESS DRILL

- ▶ Voltage : 24V
- ▶ No load speed:0-400/0-1100rpm
- ▶ Chuck:2-13MM
- ▶ Torque: 8+1 torque setting Max:20Nm
- ▶ With impact function



Item no.	Contents
87 15 00 04	

CORDLESS DRILL

- ▶ Voltage: 12V
- ▶ No-load speed:0-500min-1
- ▶ Chuck:0.8-10MM
- ▶ Torque:16+1
- ▶ Quick charger: 1hours



Item no.	Contents
87 90 00 12	

ELECTRIC SCISSORS JACK

- ▶ Voltage: DC12V
- ▶ Max current:10A
- ▶ Capacity:1T/1.5T/2T
- ▶ Height:12CM-35CM
- ▶ Cable length:4.5M



Item no.	Contents
87 99 00 07	

**ELECTRIC TIRE WRENCH AND
SCISSORS JACK**



Item no.	Contents
87 90 00 08	1pc tire wrench 1pc 1.5T scissors jack
	1pc manual handle 1pc car fuse 15A 1pc extension bar
	1 couple battery clamp 4pcs sockets CR-V 17/19,21/23mm

ANGLE GRINDER SUPPORT

► For angle Grinder 115, 125mm; GS-Approval



Item no.	Contents
87 80 00 03	

KEYLESS CHUCK



Item no.	Contents
87 80 30 01	0.8-10 3/8-24UNF
87 80 30 02	0.8-10 1/2-20UNF
87 80 30 03	1.5-13 3/8-24UNF
87 80 30 04	1.5-13 1/2-20UNF

DRILL STAND

► Holding diameter: 43mm



Item no.	Contents
87 80 00 01	

ANGLE GRINDER SUPPORT

► For angle Grinder 180, 230mm; GS-Approval



Item no.	Contents
87 80 00 04	

KEYLESS CHUCK



Item no.	Contents
87 80 30 05	0.8-10 3/8-24UNF
87 80 30 06	0.8-10 1/2-20UNF
87 80 30 07	1.5-13 3/8-24UNF
87 80 30 08	1.5-13 1/2-20UNF

DRILL HOLDER

- Height 400mm
- Drilling Depth 60mm
- Holding Dia.: 43mm
- GS-Approval



Item no.	Contents
87 80 00 02	

ANGLE GRINDER SUPPORT

► For angle Grinder 180, 230mm; GS-Approval



Item no.	Contents
87 80 00 05	





KEYLESS CHUCK



Item no. Contents

87 80 30 09	0.8-10 3/8-24UNF
87 80 30 10	0.8-10 1/2-20UNF
87 80 30 11	1.5-13 3/8-24UNF
87 80 30 12	1.5-13 1/2-20UNF

KEY TYPE CHUCK



Item no. Contents

87 80 30 21	0.6-6
87 80 30 22	1.5-10
87 80 30 23	1.5-13
87 80 30 24	3-16

ELECTRIC TOOL WRENCH

- ▶ Adjustable 20-35mm
- ▶ steel, electrophoresis



Item no. Contents

87 80 50 05	
-------------	--

KEYLESS CHUCK WITH LOCK SYSTEM



Item no. Contents

87 80 30 13	0.8-10 3/8-24UNF
87 80 30 14	0.8-10 1/2-20UNF
87 80 30 15	1.5-13 3/8-24UNF
87 80 30 16	1.5-13 1/2-20UNF

ANGLE CHUCK

- ▶ Capacity 1.5-10mm
- ▶ with key



Item no. Contents

87 80 30 25	
-------------	--

ELECTRIC TOOL WRENCH

- ▶ 35mm
- ▶ steel, electrophoresis



Item no. Contents

87 80 50 06	
-------------	--

KEYLESS CHUCK WITH LOCK SYSTEM

- ▶ Fully metal shell



Item no. Contents

87 80 30 17	0.8-10 3/8-24UNF
87 80 30 18	0.8-10 1/2-20UNF
87 80 30 19	2-13 3/8-24UNF
87 80 30 20	2-13 1/2-20UNF

CHUCK KEY



Item no. Contents

87 80 50 01	6mm
87 80 50 02	10mm
87 80 50 03	13mm
87 80 50 04	16mm

FLEXIBLE POWER SHAFT

- ▶ Size:90cm



Item no. Contents

87 80 60 01	
-------------	--

BEVEL PLATEN

- ▶ Size 45x10, bore: 14x2
- ▶ Steel, black finish



Item no.	Contents
87 80 00 01	

MINI ELECTRON PLIER

- ▶ Cutting capacity:0.6mm
- ▶ 45# steel,black finished,hardened,heat treatment
- ▶ Dipped handles



Item no.	Contents
87 80 00 03	5"

PLAIN PLATEN

- ▶ Szie 45x10,bore : M14x2
- ▶ Steel, black finish



Item no.	Contents
87 80 00 01	

MINI ELECTRON PLIER

- ▶ Cutting capacity:0.6mm
- ▶ 45# steel ,black finished,hardened ,heat treatment
- ▶ Dipped handles



Item no.	Contents
87 80 00 02	5"

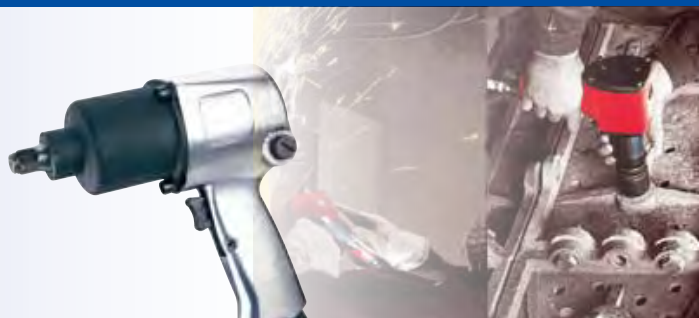

1/2" DR AIR IMPACT WRENCH

- ▶ In regulator to prevent over-torquing.
- ▶ Ideal for tire changing, shock & spring works and other automotive works
- ▶ Expansion Type:
88 30 00 01 A (with long anvil);
88 30 00 01 B (painted);
88 30 00 01 C (soft grip available)



Item no.	Contents
88 30 00 01	1/2"

1/2" HEAVY DUTY AIR IMPACT WRENCH (INDUSTRIAL LEVEL)

- ▶ Durable twin hammer impact mechanism.
- ▶ Pressure-feed lubrication)
- ▶ Adjustable power regulator, easy-to-service
- ▶ Two-piece construction.
- ▶ Variable speed, high torque.
- ▶ Sheer power and performance features to tackle the toughest jobs with ease and proven durability and economy.
- ▶ Ideal for tire changing and general assembling work and other workshop applications
- ▶ Front exhaust



Item no.	Contents
88 30 00 04	

1" DR AIR IMPACT WRENCH

- ▶ Built-in adjustable speed regulator. Oil bath lubrication.
- ▶ Removable side handle for greater control.
- ▶ Extended anvil reaches into deep truck wheels easily.
- ▶ Ideal for general repair work on trucks, tires and heavy equipment.
- ▶ Expansion type
88 30 00 07B (swing hammer instead of rocking dog)



Item no.	Contents
88 30 00 07	1"

1" DR AIR IMPACT WRENCH

- ▶ Reverse lever in forward and reverse, and 3-position power regulator.
- ▶ Components with durable and heavy duty materials.
- ▶ Removable side handle provides excellent control.
- ▶ Ideal for high volume repair works on trucks, tires and heavy equipment.



Item no.	Contents
88 30 00 08	1"

3/4" DR AIR IMPACT WRENCH

- ▶ Pistol grip for comfortably and easily handling Ideal for spring works, pion nut removal and major engine teardown.
- ▶ Expansion Type: A (painted); B (with long anvil); C (soft grip available)



Item no.	Contents
88 30 00 02	3/4"

1/2" COMPOSITE AIR IMPACT WRENCH

- ▶ Lightweight and durable composite motor housing, reversible
- ▶ Adjustable torque
- ▶ Built-in air regulator varies speed & power
- ▶ Ideal for tire changing and general assembling work and other workshop applications
- ▶ Front exhaust



Item no.	Contents
88 30 00 05	

1/2" DR AIR RATCHET WRENCH

- ▶ Useful for running small fasteners in tight space.
- ▶ Designed for body shop works, radiator, spark plug, air condition & water pump works.
- ▶ Expansion Type
88 30 00 09 A (painted)
88 30 00 09 B (soft grip available)



Item no.	Contents
88 30 00 09	

3/8" DR AIR IMPACT WRENCH

- ▶ Pistol grip for comfortably and easily handling.
- ▶ Ideal for exhaust system, air condition, and small engine works.



Item no.	Contents
88 30 00 03	3/8"

3/8" DR BUTTERFLY AIR IMPACT WRENCH

- ▶ Swivel air inlet provides easily handling Butterfly throttle for transmission, body panel, exhaust system and small engine repair.



Item no.	Contents
88 30 00 06	3/8"

3/8" DR AIR RATCHET WRENCH

- ▶ Useful for running small fasteners in tight space.
- ▶ Designed for body shop works, radiator, spark plug, air condition & water pump works.
- ▶ Expansion Type
88 30 00 10A (painted)
88 30 00 10B(soft grip available)



Item no.	Contents
88 30 00 10	

1/4" DR AIR RATCHET WRENCH

- ▶ Triple planetary gears design, with silencer for noise reduction.
- ▶ Ideal for small engine repair, headlight bench jobs.
- ▶ Expansion Type:
88 30 00 11A (painted)



Item no.	Contents
88 30 00 11	

1/2" AND 3/8" AIR RATCHET WRENCH

- ▶ Steel angle head & light aluminum body, ergonomic grip
- ▶ Most popular ratchet in the automotive industry like body shop, removing or replacing radiators, spark plugs, air conditioning, and water pumps
- ▶ Also compact and powerful for running small bolts in tight places
- ▶ Middle exhaust



Item no.	Contents
88 90 00 01	

1/2" & 3/8" AIR RATCHET WRENCH

- ▶ Steel angle head & lightweight aluminum housing with bicolor soft grip
- ▶ Most popular ratchet in the automotive industry like body shop, removing or replacing radiators, spark plugs, air conditioning, and water pumps
- ▶ Also compact and powerful for running small bolts in tight places
- ▶ Middle exhaust



Item no.	Contents
88 90 00 02	

17PC 1/2" AIR IMPACT WRENCH KIT



Item no.	Contents
88 90 00 03	AIR RATCHET WRENCH
	7-Air sockets:9,10,11,13,14,17,19mm
	1-3/8"x3" Extension bar
	1-Univ joint 1-Adaptor
	1-Oil pot 1-Nipple
	3-Bits 1-Blow case
	Dissimilarities: 1/2"x3" Extension bar instead of 3/8"x3" Extension bar
	1-3/8" to 1/2" Adaptor added

4" AIR HIGH SPEED GRINDER

- ▶ Built-in speed regulator.
- ▶ To fit with 4"(100mm) grinding wheel.
- ▶ Designed for light sanding works of feather edging, rust removal.
- ▶ Expansion Type:
88 40 00 01A (painted)



Item no.	Contents
88 40 00 01	4"

3" AIR CUT OFF TOOL

- ▶ Lightweight aluminum housing with bicolor soft grip
- ▶ Lever lock throttle for safety
- ▶ Chrome-plated steel guard protects you from sparks at operation
- ▶ To cut off mufflers, tail pipes and bolts quickly and efficiently
- ▶ Rear exhaust



Item no.	Contents
88 40 00 02	

3" AIR CUT-OFF TOOL

- ▶ To cut off mufflers and tail pipes quickly and efficiently.
- ▶ A chrome plated steel protect you from sparks.
- ▶ Expansion Type:
88 40 00 03A(painted)
88 40 00 03B(soft grip available)



Item no.	Contents
88 40 00 03	3"

150MM AIR HAMMER(ROUND/HEX)

- ▶ Economic powerful air hammer.
- ▶ Designed for exhaust system works, general cutting, chipping & scraping.
- ▶ Expansion type:
88 20 00 01A (painted)
88 20 00 01B (soft grip available)



Item no.	Contents
88 20 00 01	150mm

190MM AIR HAMMER(ROUND/HEX)

- ▶ Economic fast cutting air hammer.
- ▶ Designed for exhaust works, panel cutting and general repair.
- ▶ Expansion Type:
88 20 00 02A (painted)
88 20 00 02B (soft grip available)



Item no.	Contents
88 20 00 02	190mm



AIR NEEDLE SCALERAIR HAMMER

- ▶ Free speed RPM:4600
- ▶ Air CFM:4
- ▶ Consumption m3/min:0.113
- ▶ Chisel in.:1-5/8
- ▶ Shank mm:41
- ▶ Stroke in./mm:0.401/10.2
- ▶ Air inlet:1/4"



Item no.	Contents
88 20 00 03	

1/4" AIR DIE GRINDER

- ▶ Light weight, compact and easily handing.
- ▶ Ideal for grinding, edge-breaking, deburring, porting and polishing.
- ▶ Expansion Type:
88 40 00 04A(painted)
88 40 00 04B(soft grip available)



Item no.	Contents
88 20 00 04	1/4"

1/4" MINI AIR DIE GRINDER

- ▶ Light weight, compact and easily handing.
- ▶ Ideal for grinding, edge-breaking, deburring, porting and polishing.
- ▶ Expansion Type:
88 40 00 05A (painted)
88 40 00 05B (soft grip available)



Item no.	Contents
88 20 00 05	1/4"

AIR ANGLE DIE GRINDER

- ▶ Angle head provides easy access into tight space.
- ▶ Ideal for grinding, edge-breaking, deburring, porting and polishing.
- ▶ Expansion Type:
88 40 00 06A (painted)
88 40 00 06B (soft grip available)



Item no.	Contents
88 20 00 06	

1/4"(6MM) MINI AIR DIE GRINDER

- ▶ Lightweight aluminum housing with bi-color soft grip
- ▶ Lever lock throttle for safety
- ▶ Built-in regulator
- ▶ Also available for 1/8"(3mm)collet(optional)
- ▶ Used with a variety of accessories for weld beaking, smoothing sharp edges deburring, polishing and grinding
- ▶ Rear exhaust



Item no.	Contents
88 40 00 07	

1/4"(6MM) MINI EXTENDED AIR DIE GRINDER (1" & 3" & 5" SHAFT, CHROME PLATED)

- ▶ Lightweight aluminum housing with bi-color soft grip
- ▶ Lever lock throttle for safety
- ▶ Built-in regulator
- ▶ Also available for 1/8"(3mm)collet(optional)
- ▶ 1" & 3" & 5" inch extended collet tube to reach deeper area or tighter space
- ▶ Used with a variety of accessories for weld beaking, smoothing sharp edges deburring, polishing and grinding
- ▶ Rear exhaust



Item no.	Contents
88 90 00 04	

1/4"(6MM) AIR ANGLE DIE GRINDER

- ▶ Angle head provides easy access into tight space
- ▶ Lever lock throttle for safety
- ▶ Ideal for grinding, edge-breaking, deburring, and polishing
- ▶ Rear exhaust



Item no.	Contents
88 40 00 08	

1/4"(6MM) AIR ANGLE DIE GRINDER

- ▶ lightweight aluminum housing with bi-color soft grip and golden black anodized angle head
- ▶ Lever lock throttle for safety
- ▶ Built-in regulator
- ▶ Angle head provides easy access into tight space
- ▶ Also available for 1/8"(3mm) collet(optional)
- ▶ Used with a variety of accessories for grinding, edge-breaking, deburring and polishing
- ▶ Rear exhaust



Item no.	Contents
88 40 00 09	

1/4"(6MM) AIR ANGLE DIE GRINDER



Item no.	Contents
88 90 00 05	1pc-air angle die grinder 5 pcs-1/4"(6mm)shank grinding stones 5 pcs-1/8"(3mm)shank grinding stones 1pc-nipple 2pcs-wrenches 1pc-1/8"(3mm)collet 1pc-blow mould case

3" AIR CUT OFF TOOL & 1/4" DIE GRINDER KIT



Item no.	Contents
88 90 00 06	1pc-air cut off tool 2 pcs-cutting wheels 10 pcs-mounted stones 1 pc-safety guard 2 pcs-open end wrench 1 pc-allen wrench 1 pc-cutting wheel shank 1 pc-nipple 1 pc -collet 1 pc-mounted stone holder 1 pc blow mould case

MICRO AIR DIE GRINDER

- ▶ Slim and comfortable design for greater accessibility
- ▶ Built-in variable speed twist air regulator
- ▶ Convenient hose with hose protector
- ▶ Nipple and wrenches included
- ▶ Ideal for final cleaning and polishing of dies, jewelry and hobby use too.
- ▶ Rear exhaust



Item no.	Contents
88 80 00 01	

MICRO AIR DIE GRINDER KIT



Item no.	Contents
88 90 00 07	1pc-micro die grinder 1pc-mini oiler 1pc-oil pot 2pcs-hand wrenches 1pc-female nipple 10 pcs-mounted stone 1pc-plastic case

3/8" AIR DRILL

- ▶ Quiet operation with built-in muffler.
- ▶ Variable speed throttle for easily starting.
- ▶ Designed for drilling, honing, and hole sawing.
- ▶ Expansion Type:
88 15 00 01A (painted)
88 15 00 01B (soft grip available)



Item no.	Contents
88 15 00 01	3/8"

1/2"KEYLESS REVERSIBLE AIR DRILL

- ▶ Convenient one-hand operation with side-mounted F/R lever.
- ▶ More power and longer life.
- ▶ Powerful choice for drilling, honing and hole sawing.
- ▶ Expansion Type:
88 15 00 02A (painted)
88 15 00 02B (soft grip available)



Item no.	Contents
88 15 00 02	1/2"

3/8" KEYLESS AIR DRILL(COMPOSITE GRIP)

- ▶ Durable lightweight aluminum housing
- ▶ Variable speed throttle for easy start
- ▶ Ergonomic choice for drilling, honing, and hole sawing
- ▶ 360° handle exhaust rotation directs air away from working area



Item no.	Contents
88 15 00 03	3/8"

1/2" REVERSIBLE AIR DRILL

- ▶ Convenient side mounted f/r lever
- ▶ Variable speed throttle
- ▶ Heavy duty ball and needle bearing
- ▶ More power and longer life
- ▶ Powerful choice for drilling, honing, and hole sawing
- ▶ Handle exhaust



Item no.	Contents
88 15 00 04	1/2"

3/8" IN LINE GRINDER/DRILL

- ▶ Lightweight aluminum housing with bicolor soft grip and golden
- ▶ black anodized angle head
- ▶ Lever lock throttle for safety
- ▶ Functions as a grinder when fitted with grinding accessories and also
- ▶ as a high-speed drill when fitted with a drill for wood-working, hole drilling of aluminum and other soft metal
- ▶ Rear exhaust



Item no.	Contents
88 15 00 05	3/8"

HIGH SPEED AIR TIRE BUFFER/DRILL

- ▶ Lightweight aluminum housing with bi-color soft grip and golden black anodized head sleeve
- ▶ Variable speed throttle for easy start
- ▶ Functions as a high-speed tire buffer when fitted with tire buffing accessories
- ▶ and also as a 3/8" high-speed drill when fitted with a drill for wood-working, hole drilling of aluminum and other soft metal
- ▶ Rear exhaust



Item no.	Contents
88 15 00 06	

3/8" AIR STRAIGHT DRILL

- ▶ Variable speed throttle for easily starting.
- ▶ Quiet operation with rear exhaust.
- ▶ Ideal for drilling, honing and hole sawing.



Item no.	Contents
88 15 00 07	3/8"

4" AIR ANGLE GRINDER

- ▶ Dead handle for easy operation control.
- ▶ Come with Roll-type throttle.
- ▶ Designed for removing rust, smoothing welds.
- ▶ Expansion Type:
88 40 00 11A (painted)



Item no.	Contents
88 40 00 11	4"

5" AIR HIGH SPEED SANDER

- ▶ Built-in speed regulator.
- ▶ Comes complete with 3 resin fiber backing pads, 3", 4-1/2", 5"
- ▶ Designed for light sanding works of feather edging and rust removal.
- ▶ Expansion Type:
88 40 00 12A (painted)



Item no.	Contents
88 40 00 12	5"

6" AIR D.A. SANDER

- ▶ Swirl-free finishes form its dual action pad motion.
- ▶ Built-in regulator for positive speed control.
- ▶ Designed for sanding works of feather edging, metal preparation and blending body filler.



Item no.	Contents
88 40 00 13	6"



6" AIR D.A. SANDER

- ▶ Swirl-free finishes from its dual action pad motion.
- ▶ Built-in regulator for positive speed control.
- ▶ Designed for sanding works of feather edging, metal preparation and blending body filler.
- ▶ More delicate design of motor cover for better motor protection.



Item no.	Contents
88 40 00 14	6"

6" RANDOM ORBIT SANDER(NON-VACUUM)

- ▶ Free Speed:9000rpm
- ▶ Sanding Pad:6"/150mm
- ▶ Air Inlet(PT):1/4"
- ▶ Air Hose(ID):3/8"
- ▶ Avg.Air Consumption:12cfm/340l/min
- ▶ Sug.Air Comp:2.0HP



Item no.	Contents
88 40 00 15	6"

AIR ORBITAL SANDER

- ▶ Free Speed:8,000rpm
- ▶ Air Inlet(PT):1/4"
- ▶ Air Hose(ID):3/8"
- ▶ Avg.Air Consumption:6cfm/171l/min
- ▶ Sug.Air Comp:2.5HP



Item no.	Contents
88 40 00 16	

STRAIGHT LINE AIR SANDER

- ▶ Positive locking clamps hold paper secure.
- ▶ Low noise and vibration levels.
- ▶ No dead point design for comfortable operation performs on plastic fillers at any stage of hardening, feathers with ease and smoothness



Item no.	Contents
88 40 00 17	

AIR SCREW DRIVER

- ▶ 360 degree adjustable air regulator for variable speed.
- ▶ Reversible switch.
- ▶ Quick change chuck.
- ▶ Expansion Type:
88 45 00 01A(Gdd of head)



Item no.	Contents
88 45 00 01	

AIR SCREW DRIVER(308C)

- ▶ High torque remove tight screws easily.
- ▶ Air regulator for positive speed control.



Item no.	Contents
88 45 00 02	

PISTOL GRIP AIR SHEAR

- ▶ Shears plastic, tin, aluminum, steel and other metals.
- ▶ Use for duct work and auto body repair.
- ▶ Hardened steel blades cut up to 18-gauge steel.



Item no.	Contents
88 25 00 01	

IN-LINE AIR SHEAR

- ▶ Shears plastic, tin, aluminum, steel and other metals.
- ▶ Use for duct work and auto body repair.
- ▶ Hardened steel blades cut up to 18-gauge steel.



Item no.	Contents
88 25 00 02	

AIR NIBBLER

- ▶ Light weight and compact design.
- ▶ Cuts up to 16-gauge(1.5mm) steel without leaving burrs or deformed edges.
- ▶ Adjustable die can be placed in various cutting positions to suit applications.



Item no.	Contents
88 25 00 03	

HIGH SPEED AIR BODY SAW

- ▶ Level throttle and adjustable regulator.
- ▶ 10000 strokes per minute for fast and smooth cutting.
- ▶ Adjustable blade guard to control depth of cut.
- ▶ Excellent for body shop repair, muffler and exhaust work.
- ▶ Sun roof installations.



Item no.	Contents
88 25 00 04	

SPRAY GUN

- ▶ Optional nozzle:1.5-2.5mm
- ▶ Cup capacity:1000ml
- ▶ Pattern width:250mm



Item no.	Contents
88 10 00 01	

PROFESSIONAL PAINTING GUN

- ▶ Fluid nozzle:1.3mm,1.4mm,1.7mm,2.0mm
- ▶ Aluminum cup:1000CC
- ▶ Pattern width:160-220mm



Item no.	Contents
88 10 00 02	

PROFESSIONAL PAINTING GUN

- ▶ Fluid nozzle:1.4mm,1.7mm,1.8mm,2.0mm
- ▶ Aluminum cup:600CC
- ▶ Pattern width:140-260mm



Item no.	Contents
88 10 00 03	

SPRAY GUN

- ▶ Optional nozzle:1.2-2.5mm
- ▶ Cup capacity:600ml
- ▶ Pattern width:190mm



Item no.	Contents
88 10 00 06	

AIR BRUSHES(DUAL ACTION-SIDE GRAVITY FEED)

- ▶ Superb atomization and credible control
- ▶ Sprays an entire range of stipple effects from very fine to coarse textures
- ▶ Ideal for professional use where heavier paints are required(0.23mm nozzle) or when larger work is being created
- ▶ Dual-action trigger air-paint control
- ▶ Standard nozzle:0.23mm
- ▶ Optional nozzle:0.25,0.3mm
- ▶ Cup capacity:7 ml
- ▶ Working pressure:15-50 PSI



Item no.	Contents
88 10 00 09	

LOW PRESSURE SPRAY GUN

- ▶ Fluid nozzle:1.5mm
- ▶ Aluminum cup:1000CC
- ▶ Pattern width:200-290mm



Item no.	Contents
88 10 00 04	

AIR BRUSHES(DUAL ACTION-TOP FEED)

- ▶ Fulfills a wide range for those who require outstanding control,superior atomization and fine consistent details
- ▶ when spraying small amounts of paint in small-to-medium sized areas
- ▶ great for high precision and high detail work
- ▶ Dual-action trigger air-paint control
- ▶ Top feed cup cleans quickly for rapid color changes
- ▶ Standard nozzle:0.18mm
- ▶ Optional nozzle:0.2,0.25,0.3mm
- ▶ Cup capacity:2ml
- ▶ Working pressure:15-50 PSI



Item no.	Contents
88 10 00 07	

BLOWING GUN

- ▶ Blowing gun suitable for the removal of wood shavings,dust and general purpose cleaning
- ▶ Working pressure:4 bar
- ▶ Air consumption:150 lt/min



Item no.	Contents
88 10 00 10	

LOW PRESSURE SPRAY GUN

- ▶ Fluid nozzle:1.2mm
- ▶ Aluminum cup:800CC
- ▶ Pattern width:200-290mm



Item no.	Contents
88 10 00 05	

AIR BRUSHES(DUAL ACTION-TOP FEED)

- ▶ Fulfills a wide range for those who require outstanding control,superior atomization and fine consistent details
- ▶ when spraying small amounts of paint in small-to-medium sized areas
- ▶ great for high precision and high detail work
- ▶ Dual-action trigger air-paint control
- ▶ Top feed cup cleans quickly for rapid color changes
- ▶ Standard nozzle:0.18mm
- ▶ Optional nozzle:0.2,0.25,0.3mm
- ▶ Cup capacity:2ml
- ▶ Working pressure:15-50 PSI



Item no.	Contents
88 10 00 08	

AIR GREASE GUN

- ▶ Pistol-type, single shot gun suitable for agricultural, automotive and industrial applications.
- ▶ Three methods of grease loading, available:standard 400 cartridges, filler pump and bulk.
- ▶ With rigid and flexible tubes.
- ▶ In color box



Item no.	Contents
88 10 00 11	



FINISH NAILER

- ▶ Aluminum oxidized magazine for durability and large capacity.
- ▶ 360°adjustable air deflector for appropriate air direction.
- ▶ Quick-release nosepiece for fast clearing of jams.
- ▶ Economical air consumption with low noise.
- ▶ Single or Sequential firing style is available.



Item no.	Contents
88 50 00 01	

2 IN 1 COMBI NAILER

- ▶ 2-In-1 magazine design, shoot both 18 Ga. Brads and 18 Ga. Staples.
- ▶ Touch-strike security system is safe for the operator.
- ▶ Adjusting wheel to control the nails depth.
- ▶ Adjustable Air Exhaust.



Item no.	Contents
88 50 00 02	

BRAD NAILER

- ▶ Quick clear nose



Item no.	Contents
88 50 00 03	

WIDE CROWN STAPLER

- ▶ Easily open magazine latch for fast loading by one hand.
- ▶ Continuous operation for high efficiency.
- ▶ Touch -strike security system is safe for the operator.



Item no.	Contents
88 50 00 05	

21°ROUND HEAD FRAMING NAILER

- ▶ Rubber nose-piece protects the working surface.
- ▶ Large piston for increased power.
- ▶ 360°adjustable deflector for appropriate air direction.
- ▶ Rubber comfortable grip.
- ▶ Safety system protects the operator.
- ▶ Tool hook can be installed.
- ▶ Single fire or Sequential fire available.
- ▶ Standard equipment:
- ▶ Nailer, carrying case, oil, allen wrenches, googgle and operating manual.
- ▶ Application: Framing, Wall Sheathing, Roof Sheathing, Floor Decking



Item no.	Contents
88 50 00 04	

3/16" AIR HYDRAULIC RIVETER KIT

- ▶ Kit including 3 sizes of rivets (3/16", 5/32", 1/8", 10pc per package)
- ▶ and all necessary accessories for replacement like nosepieces (3/16", 5/32", 1/8", 3/32"), nipple, oil pot, return springs, O-rings, wrenches, and etc.



Item no.	Contents
88 90 00 08	3/16"

17PCS 1/2" AIR IMPACT WRENCH KIT



Item no.	Contents
88 90 00 09	1-Mini oiler (or Univ, joint)
	1-Oil pot
	1-Nipple
	1-1/2" DR 10mm Extension bar
	10-1/2" DR sockets:9,10,11,13,14,17,19,22,24,27mm
	1-4mm Hex key wrench
	1-Blow mold case

14PCS 3/4" AIR IMPACT WRENCH KIT



Item no.	Contents
88 90 00 10	8-impact sockets 26,27,29,30,32,35,36,38mm
	2-Hex wrenches 4mm,5mm
	1-Nipple
	1-Oil pot
	1-Blow mold case

14PCS 3/4" AIR IMPACT WRENCH KIT



Item no.	Contents
88 90 00 11	1/2" AIR IMPACT WRENCH
	6" D.A.SANDER
	6mm AIR DIE GRINDER
	150mm AIR HAMMER
	3/8" AIR DRILL
	1-4mm Hex key wrench
	1-Oil pot
	10-1/2" DR sockets:9,10,11,13,14,17,19,22,24,27mm
	1-1/2" DR 5" Extension bar
	1-6" Pad
	2-Hand wrenches
	5-6mm mounted grinding stones
	5-3mm mounted grinding stones
	1-Collet chunk
	1-Spring retainer
	4-125mm round shank chisels
	1-Chuck key
	4-50mm Bits

14PCS AIR WRENCH KIT



Item no.	Contents
88 90 00 12	1/2" AIR IMPACT WRENCH 3/8" AIR RATCHET WRENCH 7-1/2" DR.Air impact sockets:7/16", 1/2", 9/16", 5/8", 11/16", 3/4", 13/16" 1-3/8" to 1/2" Adaptor 1-Mini oiler 1-Hex wrench 1-Oil pot 1-Nipple Dissimilarities: 3-Sockets 7/8", 15/16", 1" added 1-3/8" to 1/2" Adaptor deleted

17PCS 1/2" AIR IMPACT WRENCH KIT



Item no.	Contents
88 90 00 13	AIR RATCHET WRENCH 7-Air sockets:9,10,11,13,14,17,19mm 1-3/8"x3" Extension bar 1-Univjoint 1-Adaptor 1-Oil pot 1-Nipple 3-Bits 1-Blow case Dissimilarities: 1/2"x3" Extension bar instead of 3/8"x3" Extension bar 1-3/8" to 1/2" Adaptor added

1/4"(6MM) AIR DIE GRINDER KIT



Item no.	Contents
88 90 00 14	2-Hand wrenches 1-3mm (1/8") Collet 5-1/4"(6mm) Shank grinding stones 5-1/8"(3mm) Shank grinding stones 1-Nipple 1-Blow mold case

1/4"(6MM) AIR ANGLE DIE GRINDER KIT



Item no.	Contents
88 90 00 15	AIR ANGLE DIE GRINDER 10-Mounted stones 1-Nipple 2-Wrenches 1-1/8"(3mm) Collet 1-Blow mold case

3/8" AIR DRILL KIT



Item no.	Contents
88 90 00 16	AIR DRILL 10-Twist drill bits:1.5,2, 2.5,3,3.5,4,4.5,5,5.5,6mm 1-Oil pot 1-Mini oiler 1-Drill chuck key 1-Nipple 1-Blow mold case

9PCS AIR HAMMER KIT



Item no.	Contents
88 90 00 17	1-150mm / 190mm AIR HAMMER 4-Chisels 1-Nipple 1-Oil pot 1-Sping retainer 1-Blow mold case



32PCS AIR TOOL KIT



Item no. Contents

88 90 00 18	1/2" AIR IMPACT WRENCH 1/2" AIR RATCHET WRENCH 150mm AIR HAMMER AIR DIE GRINDER 1-Spring retainer 10-1/2" DR Sockets:7/16", 1/2",9/16",5/8",11/16",3/4", 13/16",7/8",15/16",1" 5Nipples 3-Chisels 1-quick coupler 2-Hand wrenches 5-1/4" Mounted grinding stones
-------------	------------------------------------------------------------------------------------------------------------------------------------------------------------------------------------------------------------------------------------------------------------------------------------------------

71PCS AIR TOOL KIT



Item no. Contents

88 90 00 19	1-1/2" Air impact wrench 1-3/8" Air ratchet wrench 1-150mm Air hammer 1-1/4" Air die grinder 1-Air blow gun 8-Impact sockets:9,10,11, 12,13,14,17,19mm 1-3/8" to 1/2" Adaptor 1-Screw bit holder 1-Air quick coupler female 5-Male nipples 1-Female nipples 3-Chisels 1-Spring retainer 1-Ball foot air chuck 1-Rubber nozzle 1-Safety nozzle 1-High speed nozzle 1-Tapered nozzle 1-Sanding drum 1-1/4" Male-female nipple 1-1/8" Collet 2-Sport needle 10-Sanding sleeve 9-Screw bit 2-Hand wrenches 1-4mm Hex wrench 1-Tape 1-Oil pot 1-Blow mold case
-------------	--------------------------------------------------------------------------------------------------------------------------------------------------------------------------------------------------------------------------------------------------------------------------------------------------------------------------------------------------------------------------------------------------------------------------------------------------------------------------------------------------------------------------------------------------------------------------------------------------------------------------------------------------

17 PCS AIR TOOLS KIT



Item no. Contents

88 90 00 20	1 pc 1/2" air impact wrench 1 pc 150 mm air hammer 4 pc impact sockets: 17,19,22,24mm 1 pc 1/2" to 5" drive extension bar 1 pc 4 mm hex key 1 pc spring retainer 4 pc 125 mm round shank chisels 2 pc 1/4" PT male industrial plug 1 pc oil pot 1 pc blow mould case
-------------	-------------------------------------------------------------------------------------------------------------------------------------------------------------------------------------------------------------------------------------------------------------------------------------------------

15 PCS 1/2" AIR IMPACT WRENCH KIT



Item no. Contents

88 90 00 21	1 pc 1/2" air impact wrench 10 pc impact sockets:9,10,11, 13,14,17,19, 22,24,27mm 1 pc 1/2" to 5" drive extension bar 1 pc 1/4" NPT male industrial plug 1 pc oil pot 1 pc blow mould case
-------------	--------------------------------------------------------------------------------------------------------------------------------------------------------------------------------------------------------------

1" AIR IMPACT WRENCH KIT



Item no. Contents

88 90 00 22	1-1" AIR IMPACT WRENCH 2-Air sockets 38mm 41mm 1-1/2" Nipple 1-Wrench
-------------	--------------------------------------------------------------------------------

74 PCS AIR TOOL KIT



Item no. Contents

88 90 00 23	1 pc 3/8" air ratchet wrench 1 pc 1/4" air die grinder 1 pc 1/8" collet 1 pc blow gun 4 pc impact sockets: 1/2", 5/8", 9/16", 3/4" 1 pc 3/8" to 1/2" drive adaptor 1 pc 3/8" to 1/4" dr. screwdriver bit holder 4 pc 1/4" NPT male industrial plug 1 pc 1/4" NPT(F) quick coupler 9 pc air power nut drivers: 5/32", 3/16", 7/32", 1/4", 9/32", 5/16", 11/32", 3/8", 7/16" 12 pc bits 1 pc 60 mm bit holder 1 pc oil pot 9 pc air power nut drivers: 5/32", 3/16", 7/32", 1/4", 9/32", 5/16", 11/32", 3/8", 7/16" 12 pc bits 1 pc 60 mm bit holder 1 pc oil pot 1 pc tape 1 pc 1/4" NPT(N/M) connector 1 pc 1/4"NPT(F/F) connector 1 pc rubber nozzle 1 pc safety nozzle 1 pc inflation needle 1 pc tapered nozzle 1 pc high pressure nozzle 1 pc blow gun adaptor 1 pc dual head tire gauge 10 pc sanding drumsleeves 2 pc sanding drum 10 pc mounted grinding stones 2 pc 14-19mm hand wrenches 1 pc blow mould case
-------------	---------------------------------------------------------------------------------------------------------------------------------------------------------------------------------------------------------------------------------------------------------------------------------------------------------------------------------------------------------------------------------------------------------------------------------------------------------------------------------------------------------------------------------------------------------------------------------------------------------------------------------------------------------------------------------------------------------------------------------------------------------------------------------------------------------------------------------------------------------------------------------------------------------------------------------------------------------------------------------------------------------------------------

15 PCS AIR TOOL KIT



Item no.	Contents
88 90 00 24	1pc-1/2" air impact wrench
	1pc-3/8" air ratchet wrench
	7pcs-1/2"dr.air impact socket 9,10,11,13,14,17,19mm
	1pc-3/8" to 1/2" adaptor
	1pc-mini oiler
	1pc-hex wrench
	1pc-oil pot
	1pc-nipple
	1pc-blow mould case

PVC REINFORCED AIR HOSE

- ▶ Made of high class plastic, with fabric being resistant of tiering interior diam. 6 mm,
- ▶ for a working pressure of 15 bar complete with both connection



Item no.	Contents
88 80 00 02	6mmx10m
88 80 00 03	6mmx15m

PU REINFORCED AIR HOSE

- ▶ Lightweight & easy to handle
- ▶ Resists kinking
- ▶ -20 F to +125 F working temperature
- ▶ Reinforced with polyester fibers
- ▶ Brass 1/4" PT male swivel fittings
- ▶ Oil and grease resistant



Item no.	Contents
88 80 00 04	1/4"x30'
88 80 00 05	1/4"x100'

PU COILED AIR HOSE

- ▶ Strong tensility, strong anti-avulsion, free from wear and tear, anti-high temperature, anti-low temperature, anti-high pressure, anti-bending, anti-oil corruption, strong spring ability, non-toxic,
- ▶ For a working pressure of 15 bar complete with both connection



Item no.	Contents
88 80 00 06	1/4"x15'
88 80 00 07	3/8"x25'

5 PCS AIR TOOLS KIT SUCTION/GRAVITY SPRAY GUN

- ▶ Contains:painting gun,blowing gun,washing gun,inflating gun,spiral hose,mainly used for car maintaining,it can supply spraying paint,blowing off dust,pumping air to cars
- ▶ Kit can be supplied with italian fitting,german quick coupling american quick coupling japanese quick coupling



Item no.	Contents
88 90 00 25	

5 PCS AIR TOOLS KIT SUCTION/GRAVITY SPRAY GUN

- ▶ Contains:painting gun,blowing gun,washing gun,inflating gun,spiral hose,mainly used for car maintaining,it can supply spraying paint,blowing off dust,pumping air to cars
- ▶ Kit can be supplied with italian fitting,german quick coupling american quick coupling japanese quick coupling



Item no.	Contents
88 90 00 26	

MALE NIPPLE(BRASS)



Item no.	Contents
88 80 20 01	

MALE NIPPLE(BRASS)



Item no.	Contents
88 80 20 02	

MALE NIPPLE(BRASS)



Item no.	Contents
88 80 20 03	

FEMALE NIPPLE(BRASS)



Item no.	Contents
88 80 20 04	

FEMALE NIPPLE(BRASS)



Item no.	Contents
88 80 20 05	

MALE NIPPLE(STEEL)



Item no.	Contents
88 80 20 06	



FEMALE NIPPLE(STEEL)



Item no.	Contents
88 80 20 07	

3WAY AIR QUICK COUPLER



Item no.	Contents
88 80 20 11	

5WAY AIR QUICK COUPLER



Item no.	Contents
88 80 20 15	

FEMALE NIPPLE(STEEL)



Item no.	Contents
88 80 20 08	

3WAY AIR QUICK COUPLER



Item no.	Contents
88 80 20 12	

PNEUMATIC TOOLS

FEMALE NIPPLE(STEEL)



Item no.	Contents
88 80 20 09	

4WAY AIR QUICK COUPLER



Item no.	Contents
88 80 20 13	

2WAY AIR QUICK COUPLER



Item no.	Contents
88 80 20 10	

2WAY AIR QUICK COUPLER



Item no.	Contents
88 80 20 14	



3PCS PLASTIC TOOL BOX



Item no.	Contents
90 10 40 01	Small: 13.5" 345x185x125mm Middle: 16" 410x240x175mm Big: 20" 510x305x225mm

PLASTIC TOOL BOX

- ▶ Made of durable plastic
- ▶ Sturdy carrying handle and pad lock eye for extra security
- ▶ With removable transparent plastic box with 9 different size grids
- ▶ With single clip closure
- ▶ Solid loose with swing tag



Item no.	Contents
90 10 40 02	12"

PLASTIC TOOL BOX WITH TRAY

- ▶ Material: pp



Item no.	Contents
90 10 40 03	40x17x17.5cm

PLASTIC TOOL BOX WITH TRAY

- ▶ Material: pp



Item no.	Contents
90 10 40 04	40x17x17.5cm

STEEL & PLASTIC TOOL BOX

- ▶ High-impact resistant polypropylene (pp)
- ▶ U-sheet steel bottomed
- ▶ Sturdy one-hand handle made of high-impact resistant polypropylene(PP) and sturdy hinged steel locks for safe and convenient carriage
- ▶ Unique promotion packs, featuring a "case-in-case" design, are perfect suitable as a "crowd-puller"
- ▶ Classic tool cased for workshop, craft, household, leisure activities and happy purposes



Item no.	Contents
90 10 00 02	Small: 406X204X181mm Middle: 495X255X222mm Big: 581X297X266mm

STAINLESS & PLASTIC TOOL BOX

- ▶ Material: pp+satinless steel+stainless steel top
- ▶ Three pieces toolbox in one set



Item no.	Contents
90 10 20 01	Small: 395x185X170mm

DRAWER STEEL & PLASTIC TOOL BOX

- ▶ Material: pp+sheet iron



Item no.	Contents
90 30 00 01	49.7x25.3x28.9cm Inner size:46x22x10cm Drawer inner size:39x21.5x11cm Bearing: 40KG

DRAWER STEEL & PLASTIC TOOL BOX

- ▶ Material: pp+sheet iron



Item no.	Contents
90 30 00 02	49.7x25.3x40.7cm Inner size:46x22x10cm Drawer inner size:39x21.5x5cm Bearing:40KG

DRAWER STEEL & PLASTIC TOOL BOX

- ▶ Material: pp+sheet iron



Item no.	Contents
90 30 00 03	Size: 49.7x25.3x40.7cm Inner size:46x22x10cm Drawer inner size:39x21.5x11cm Bearing: 40KG

STEEL ROLLER TOOL BOX

- ▶ 4 Kinds of cases (A,B,C,D) for you to choose to make up of the set you need
- ▶ Features of subsidiary cases:
- ▶ A: tool case with one big drawer and two rubber wheels and the handle, 520x320x440mm
- ▶ B: tool case with two drawers made of sheet steel, 495x252x480mm
- ▶ C: tool case with one big drawer made of sheet steel, 495x252x180mm
- ▶ D: tool case of plastic and sheet steel combined, 495x254x225mm
- ▶ Ergonomically curved handle for safe and convenient carriage
- ▶ Built-in plug socket and a hidden pulled-out cable of 8 meters' long offer you and your electric tools convenient and efficient working environment
- ▶ Various combinations can be made as your requirement



Item no.	Contents
90 20 00 01	

MEDICINE BOX

- ▶ Material: high-impact resistant PP
- ▶ Sturdy hinge locks
- ▶ Portable lift-out insert tray available



Item no.	Contents
90 10 40 05	29.7x20.7x11.6cm

DOUBLE SIZE TOOL ORGANIZER WITH FIXED COMPARTMENTS

- ▶ Material: pp
- ▶ One side has 8 various compartments another side has 5 equal compartments



Item no.	Contents
90 10 40 06	17.2x10.6x4.6cm

DOUBLE SIDE TOOL ORGANIZER WITH REMOVABLE COMPARTMENTS

- ▶ Material: pp
- ▶ One side has 10 various compartments
- ▶ Another side has 2 divider make compartments from 10-22



Item no.	Contents
90 10 40 07	29.5x22x7.6cm

TRANSPARENT ORGANIZER WITH FIXED COMPARTMENTS

- ▶ Material: pp
- ▶ The organizer has 17 various compartments totally



Item no.	Contents
90 10 40 08	27.5x18.5x4.2cm

ORGANIZER WITH FIXED COMPARTMENTS

- ▶ Material: pp



Item no.	Contents
90 10 40 09	29x18x4.5cm

STORAGE BIN

- ▶ 4-side locker for endless expanding
- ▶ Each bin has 4 removable divider to make compartments from 1 to 4
- ▶ Hanging hole on back side
- ▶ Material: ps



Item no.	Contents
90 10 40 10	17.5x9x4.6cm

STORAGE BIN

- ▶ Material: pp



Item no.	Contents
90 10 40 11	10.8x12.4x6cm

STORAGE BIN

- ▶ Side locker can connect bin each other
- ▶ Additional column can expand many layers
- ▶ Material: pp



Item no.	Contents
90 10 40 12	18x12.5x8cm

MULTIDRAWER ORGANIZER

- ▶ PS material body, PE material drawers(30pcs small drawers, 9pcs big drawers) with hanging holes on the backside
- ▶ Packed in plastic shrinking



Item no.	Contents
90 10 40 13	375x160x470mm

MULTIDRAWER ORGANIZER

- ▶ PS material body, PE material drawers(18pcs big drawers) with hanging holes on the backside
- ▶ Packed in plastic shrinking



Item no.	Contents
90 10 40 14	375x160x470mm



MULTIDRAWER ORGANIZER

- ▶ PS material body, PE material drawers(8pcs small drawers) with hanging holes on the backside
- ▶ Packed in plastic shrinking



Item no.	Contents
90 10 40 15	260x160x240mm

- ▶ Material:pp
- ▶ One big box with 8 pieces of little box and one belt



Item no.	Contents
90 10 40 16	39.5x22.5x15.5cm Inner size:33x21x12cm Little box size: 18x9x3cm Bearing:10KG

ELECTRONIC COMPONENT BOX

- ▶ Double-face organizer with removable bins
- ▶ Material:pp+ps
- ▶ One side with removable bins and another side with removable septa



Item no.	Contents
90 10 40 17	Small:320x270x52mm Middle:380x300x80mm Big:480x380x80

ELECTRONIC COMPONENT BOX

- ▶ Material:pp



Item no.	Contents
90 10 40 18	41.5x22.5x24cm

PLASTIC TOOL BOX

- ▶ Material:pp
- Sturdy and durable
- With two clip closures
- Load capacity:≤ 80kg
- Lifting capacity≤20kg



Item no.	Contents
90 10 40 20	35x18x16cm 42x21x19.5cm 47.2x23x21cm

STEEL & PLASTIC TOOL BOX

- ▶ Material:pp+sheet iron+stainless steel
- Sturdy one-hand handle and two hinged steel locks for safe and convenient carriage



Item no.	Contents
90 10 40 21	36x18.5x17cm 41x21.5x18.3cm 45x24.5x19cm

PLASTIC TOOL BOX

- ▶ Material:pp
- Double-deck
- With two clip closures



Item no.	Contents
90 10 40 22	34x18x13cm 40x25x18cm 49x29x23cm

STEEL & PLASTIC TOOL BOX

- ▶ Material:pp+sheet iron
- ▶ With two hinged steel locks
- ▶ Thickness of sheet iron:0.8mm



Item no.	Contents
90 10 40 23	36x18.5x18cm 40x20x19cm 45x24x20cm

PLASTIC TOOL BOX

- ▶ Material:pp
- ▶ Sturdy and durable



Item no.	Contents
90 10 40 24	36x16x18cm 40x20x20cm 45x23x20cm

TROLLERY TOOL BAG

- ▶ Sturdy Retractable 22" Handle
- ▶ Rubber Logo Plate
- ▶ Roller Wheels
- ▶ 22 pockets for Storage
- ▶ Plastic Parts Organizer included
- ▶ Heavy Canvas Construction
- ▶ Wire reinforced Bag Opening



Item no.	Contents
90 10 60 01	15"

43 POCKETS TOOL BAG

- ▶ Rubber Logo Plate
- ▶ 43 pockets for Storage
- ▶ Heavy Canvas Construction
- ▶ Clear Side Pocket
- ▶ Shoulder Strap



Item no.	Contents
90 10 60 02	22.5"

11 POCKETS TOOL BAG

- ▶ Rubber Logo Plate
- ▶ 11 pockets for Storage
- ▶ Heavy Canvas Construction
- ▶ Mesh Side Pockets
- ▶ Shoulder Strap
- ▶ Plastic Parts Organizer included in separate compartment
- ▶ Wire reinforced Bag Opening



Item no.	Contents
90 10 60 03	12"

28 POCKETS TOOL BAG

- ▶ Rubber Logo Plate
- ▶ 28 pockets for Storage
- ▶ Heavy Canvas Construction
- ▶ Shoulder Strap
- ▶ Plastic parts organizer included in separate compartment



Item no.	Contents
90 10 60 04	8"

27 POCKET BUCKET BAG

- ▶ heavy duty bucket bag
- ▶ plastic padded feet
- ▶ reinforced & side edges



Item no.	Contents
90 10 60 05	L410XW220XH260mm

21 POCKET TOOL BAG

- ▶ Steel Swivel Handle With Soft Grip
- ▶ Heavy Duty Durable Material
- ▶ Rubber Feet On Base



Item no.	Contents
90 10 60 06	13",16",18"

HEAVY DUTY TOOL BAG

- ▶ Steel Carry Handle With Padded Grip
- ▶ Heavy Duty Water Resistant Rubber Base
- ▶ Cover Flap With Velcro & Metal latches
- ▶ 16 Internal&External Pockets
- ▶ Card Holder/I.D Slip
- ▶ Internal Plastic Loops



Item no.	Contents
90 10 60 07	W440xD250Xh360mm

LEATHER TOOL BAG

- ▶ The double bag, uses in putting the tool and the material, is advantageous for the worker to operate, raises the working efficiency.
- ▶ Material:cow leather



Item no.	Contents
90 10 60 08	L57cmXW23cm

POCKET HANDY TOOLS BAG

- ▶ Round bucket with rigid walls
- ▶ Removable rubber grip handle&padded shoulder strap provide easy access and extra comfort
- ▶ Ideal for hand tools and other small items commonly used by electricians, plumbers and technicians



Item no.	Contents
90 10 60 10	

TOOL BAG

- ▶ Opens wide for easy access
- ▶ Padded reinforced web carrying handle



Item no.	Contents
90 10 60 11	

SQUARE TOOL BAG

- ▶ With 30 pockets in total
- ▶ Surface protected by waterproof coating
- ▶ Extra padded carrying handle and adjustable shoulder strap



Item no.	Contents
90 10 60 12	

TOOL BAG

- ▶ Opens wide for easy access
- ▶ Padded reinforced web carrying handle



Item no.	Contents
90 10 60 13	

TOOL BAG WITH TUBULAR HANDLE

- ▶ A great value in large tool bag
- ▶ Open main storage compartment, with side pockets



Item no.	Contents
90 10 60 14	

SUPER OPEN MOUTH TOLS BAG

- ▶ Central zipper allows for quick access and maximum visibility to contents when opened
- ▶ Ideal for carrying hand tools and other cedium to small size items
- ▶ Injected polypropylene hard base extends life of bag by strengthening base
- ▶ Rubber grip handle and padded shoulder strap for extra comfort



Item no.	Contents
90 10 60 15	

TOOL BAG WITH FOLDING SEAT

- ▶ Seat and tool tote
- ▶ Keep tools and supplies right at hand
- ▶ Folds in half for easy storage and carrying
- ▶ Steel tube frame with a detachable fabric organizer



Item no.	Contents
90 10 60 16	

TOOL BAG WITH TUBULAR HANDLE

- ▶ A great value in large tool bag
- ▶ With tubular handle
- ▶ Classic design of stainless foamed rod



Item no.	Contents
90 10 60 17	

TOOL BAG WITH TUBULAR HANDLE

- ▶ It features 49 interior pockets and 10 exterior pockets for a wide variety of storage uses
- ▶ Zippered top for easy opening and closing
- ▶ The shoulder strap for hands-free use and a zipper top for easy opening and closing
- ▶ Front and back fold out panels for extra storage



Item no.	Contents
90 10 60 18	

ROLLING TOOL BAG

- ▶ It features 49 interior pockets and 10 exterior pockets for a wide variety of storage uses
- ▶ Zippered top for easy opening and closing
- ▶ Telescoping handle for easy use
- ▶ Front and back fold out panels for extra storage



Item no.	Contents
90 10 60 19	

MULTI-PURPOSE TOOL POUCH

- ▶ Quick-release buckle
- ▶ Large easy access main pockets for pliers and measuring tape, etc
- ▶ Small pockets for pliers, wrenches, etc



Item no.	Contents
90 10 60 20	

MINI POUCH

- ▶ pockets for screwdrivers, pliers etc



Item no.	Contents
90 10 60 21	

PROFESSIONAL UTILITY COMBO SYSTEM

- ▶ Stay open pockets design allows for easy access to pocket contents
- ▶ With steel hammer loop



Item no.	Contents
90 10 60 22	

PROFESSIONAL UTILITY COMBO SYSTEM

- ▶ Stay open pockets design allows for easy access to pocket contents
- ▶ With steel hammer loop



Item no.	Contents
90 10 60 23	

PROFESSIONAL UTILITY COMBO SYSTEM

- ▶ Stay open pockets design allows for easy access to pocket contents
- ▶ Quick release buckle



Item no.	Contents
90 10 60 24	

MINI POUCH

- ▶ 4 pocket compact pouch
- A-padded and reinforced pouch easily slips into back pocket
- B-snap loop secures to belt or tool bag handle
- C-4 front pockets hold tools, pencils, wallet and more
- D-clip loop attaches tape roll or keys
- E-Abrasion-resistant material



Item no.	Contents
90 10 60 25	

TOOL POUCH

- ▶ Open pocket for easy access and more capacity with steel hammer loop



Item no.	Contents
90 10 60 26	

PACK BAG

- ▶ 6 pockets in total
- Surface protected by waterproof coating



Item no.	Contents
90 10 60 27	



MINI POUCH

- ▶ with magnetic function
- ▶ with steel hammer loop



Item no.	Contents
90 10 60 28	

MINI POUCH

- ▶ pockets for screwdrivers, pliers etc



Item no.	Contents
90 10 60 29	

ALUMINUM TRUCK BOX

- ▶ Light weight for easy moving
- ▶ Waterproof
- ▶ Stainless hinge for long time using



Item no.	Contents
90 10 20 03	1755x400x400mm

ALUMINUM TRUCK BOX

- ▶ Light weight for easy moving
- ▶ Waterproof
- ▶ Stainless hinge for long time using



Item no.	Contents
90 10 20 04	small:760X335X245mm
90 10 20 04	middle:1230x380x380mm
90 10 20 04	big:1450x520x460mm

ALUMINUM TRUCK BOX

- ▶ Light weight for easy moving
- ▶ Waterproof
- ▶ Stainless hinge for long time using



Item no.	Contents
90 10 20 05	small:900x500x700mm
	middle:1210x500x700mm
	big:1450x500x700mm

CANTILEVER TOOL BOXES WITH TRAYS



Item no.	Contents
90 10 00 03	495x200x290mm

PORTABLE TOOL BOX



Item no.	Contents
90 10 00 04	360x150x115mm

DRAWER PORTABLE TOOL BOX



Item no.	Contents
90 10 00 05	510x218x250mm

PROFESSIONAL CHEST AND ROLLER CABINET

- ▶ Random combination & independent use of top & middle & bottom cabinets
- ▶ Internal locking system for extra security
- ▶ Multi-layer drawer design meets various storage needs
- ▶ Side locking device and automatic resetting function of each drawer
- ▶ Concave side panel structure creates high load capacity as well as fine stereo profile
- ▶ Ball bearing slide on all drawers
- ▶ Gas spring lid stay, plastic top, drawer mat
- ▶ Internal locking system for extra security
- ▶ Side locking device and automatic resetting function of each drawer
- ▶ Vibration reducing corner
- ▶ 5"x2" casters



Item no.	Contents
90 30 00 04	overall size:724x470x420mm overall:724X470X867mm overall with caster: 724X470X1032mm

TOOL CART

- ▶ Knock down structure for easy transportation
- ▶ The top moving parts can easily lock/unlock two drawers by moving in/out
- ▶ Special caster structure for quick assembling
- ▶ 4"x1" caster
- ▶ Ball bearing slide



Item no.	Contents
90 20 00 03	overall:705X370X710mm overall with caster: 705X370X30mm N.W.:27.5KG G.W.:30.5KG

TOOL CART

- ▶ Knock down structure for easy transportation
- ▶ Light compact easy-to-use mobile and flexible
- ▶ Powder coating finish
- ▶ Two swivel and two swivel with brake pin bearing
- ▶ 4"X1" caster for longer use



Item no.	Contents
90 20 00 04	overall:712X440X694mm overall with caster: 712X440X814mm N.W.:25.5KG G.W.:27KG

ROLLER CABINET

- ▶ Shine coating finish
- ▶ Wrinkle pressed sheet metal
- ▶ smooth action slide
- ▶ 2.5"X1" caster



Item no.	Contents
90 20 00 05	overall 559X307X705mm overall with casters: 559X307X785mm

PROFESSIONAL ROLLER CABINET

- ▶ Drawers can be opened in 2 way
- ▶ Sliding doors at 2 side for security locking
- ▶ 2 outer designed 6.5" caster for stable using
- ▶ Moving parts can be padlocked



Item no.	Contents
90 20 00 06	overall: 754X404X750mm overall with caster: 754X404X865mm

PROFESSIONAL ROLLER CABINET

- ▶ Heavy duty 5"X2" caster
- ▶ Powder coating finish
- ▶ Internal locking system for extra security
- ▶ 2 millimeter protective drawer liner



Item no.	Contents
90 20 00 07	overall:680X458X802 overall with caster: 680X458X945

CHEST AND ROLLER CABINETS

- ▶ Top chest can be put into roller cabinet in transportation



Item no.	Contents
90 20 00 08	chests 600x260x340mm, N.W.:11.2KG cabinets 616x330x658 (with caster742) mm N.W.:15KG

WORK STATION

- ▶ Shine coating finish
- ▶ Knock down structure
- ▶ Ball bearing drawer slid
- ▶ Durable metal top
- ▶ Rubber pad top
- ▶ Tools holder not included



Item no.	Contents
90 99 00 03	overall 1500X640X865MM N.W.:67KG G.W.:73.9KG

7PCS COMBINED TOOL KITS



Item no.	Contents
90 90 10 01	1Pcs 6" Combination pliers 1Pcs 2m Measuring tape 2Pcs 5x75+- Screwdriver 1Pcs 80v-500v Voltage tester 1Pcs 6"Adjustable wrench 1Pcs Iron case

24PCS COMBINED TOOL KITS



Item no.	Contents
90 90 10 02	1Pcs 4.5" Combination pliers 1Pcs Utility knife 8Pcs 6.7.8.9.10.11.12.13mm 1/4"sockets 1Pcs Flat gourd-form handle 10Pcs Bits 1Pcs 2m Measuring tape 1Pcs 6cm 1/4"Jonit bar 1Pcs Iron case

7PCS COMBINED TOOL KITS



Item no.	Contents
90 90 10 03	1Pcs 6" Combination pliers 1Pcs 2m Measuring tape 2Pcs 5x75+- Screwdriver 1Pcs 80v-500v Voltage tester 1Pcs Flashlight 1Pcs Iron case



24PCS COMBINED TOOL KITS



Item no.	Contents
90 90 10 04	1Pcs 4.5" Long nose pliers 3Pcs 3-5mm Hex key 4Pcs 7.8.9.10mm 1/4"sockets 1Pcs Flat gourd-form handle 10Pcs Bits 1Pcs 6cm 1/4"Jonit bar 1Pcs 3" 1/4"Jonit bar 2Pcs Precision screwdriver 1Pcs Iron case

8PCS COMBINED TOOL KITS



Item no.	Contents
90 90 10 05	1Pc 7" Combination pliers 1Pc 2m Measuring tape 1Pc Utility knife 2Pcs 100x6 +- Screwdriver 1Pc 80v-500v Voltage tester 1Pc Claw hammer 1Pc polyster zipper bag

9PCS COMBINED TOOL KITS



Item no.	Contents
90 90 10 06	1Pcs 4.5" Long nose pliers 1Pcs 4.5" Diagonal pliers 1Pcs Electrical voltage tester 2Pcs (-)2.4(+):PHO Precision screwdriver 1Pcs Impact and punch down tool 1Pcs Coaxial stripper plier 1Pcs Computer plier 1Pc polyster zipper bag

15PCS COMBINED TOOL KITS



Item no.	Contents
90 90 10 07	1Pcs 4.5" Long nose pliers 1Pcs 4.5" Diagonal pliers 1Pcs Electrical voltage tester 2Pcs (-)2.4(+):PHO Precision screwdriver 2Pcs 100x6 +- Screwdriver 1Pcs 8" Adjustable wrench 5Pcs 2-6mm Hex key 1Pcs Multimeter 1Pcs Polyster zipper bag

29PCS COMBINED TOOL KITS



Item no.	Contents
90 90 10 08	1Pcs 4.5" Long nose pliers 1Pcs 4.5" Diagonal pliers 1Pcs Flat gourd-form handle 10Pcs Bits 5Pcs 2-6mm Hex key 2Pcs (-)2.4(+):PHO Precision screwdriver 7Pcs 7.8.9.10.11.12.13mm 1/4"sockets 1Pcs 3" 1/4"Jonit bar 1Pcs Polyster zipper bag

15PCS COMBINED TOOL KITS



Item no.	Contents
90 90 10 09	1Pcs 6" Combination pliers 1Pcs 2m Measuring tape 2Pcs 100x6 +- Screwdriver 1Pcs Claw hammer 1Pcs Alloy torch 1Pcs PVC tape 5Pcs 2-6mm Hex key 1Pcs 80v-500v Voltage tester 1Pcs Utility knife 1Pcs Polyster bag

8PCS COMBINED TOOL KITS



Item no.	Contents
90 90 10 10	1Pcs 6" Combination pliers 1Pcs 3m Measuring tape 2Pcs 100x6 +- Screwdriver 2Pcs (-)2.4(+):PHO Precision screwdriver 1Pcs Flashlight 1Pcs plastic box

8PCS COMBINED TOOL KITS



Item no.	Contents
90 90 10 11	1Pcs 6" Combination pliers 1Pcs 3m Measuring tape 2Pcs 100x6 +- Screwdriver 1Pcs 8" Adjustable wrench 1Pcs Claw hammer 1Pcs Utility knife 1Pcs plastic box

12PCS COMBINED TOOL KITS



Item no.	Contents
90 90 10 14	1Pcs 6" Long nose pliers 2Pcs Voltage tester 5Pcs 2-6mm Hex key 1Pcs Claw hammer 1Pcs Utility knife 1Pcs 2m Measuring tape 1Pcs plastic box

14PCS COMBINED TOOL KITS



Item no.	Contents
90 90 10 17	1Pcs 2m Measuring tape 1Pcs Utility knife 5Pcs 2-6mm Hex key 2Pcs 100x6 +- Screwdriver 1Pcs 6" Combination pliers 1Pcs 6" Adjustable wrench 1Pcs PVC tape 1Pcs 80v-500v Voltage tester 1Pcs blow mould box

9PCS COMBINED TOOL KITS



Item no.	Contents
90 90 10 12	1Pcs 6" Combination pliers 1Pcs 2m Measuring tape 2Pcs 5x75+- Screwdriver 1Pcs 6" Adjustable wrench 1Pcs 80v-500v Voltage tester 1Pcs Utility knife 1Pcs Alloy torch 1Pcs plastic box

12PCS COMBINED TOOL KITS



Item no.	Contents
90 90 10 15	1Pcs 6" Combination pliers 2Pcs 5x75+- Screwdriver 1Pcs Claw hammer 1Pcs 6" Adjustable wrench 1Pcs Utility knife 5Pcs 2-6mm Hex key 1Pcs plastic box

8PCS COMBINED TOOL KITS



Item no.	Contents
90 90 10 18	1Pcs Utility knife 1Pcs 2m Measuring tape 2Pcs 100x6 +- Screwdriver 1Pcs 6" Combination pliers 1Pcs 8" Adjustable wrench 1Pcs electrical voltage tester 1Pcs blow mould box

9PCS COMBINED TOOL KITS



Item no.	Contents
90 90 10 13	1Pcs 6" Combination pliers 1Pcs 2m Measuring tape 2Pcs 5x75+- Screwdriver 1Pcs 8" Adjustable wrench 1Pcs 80v-500v Voltage tester 1Pcs Utility knife 1Pcs Claw hammer

26PCS COMBINED TOOL KITS



Item no.	Contents
90 90 10 16	5Pcs 7,8,9,10,11 1/4"socket wrench kits 1Pcs Flat gourd-form handle 10Pcs Bits 1Pcs 3" 1/4"jonit bar 1Pcs 4.5" Long nose pliers 1Pcs 4.5" Diagonal pliers 1Pcs Utility knife 4Pcs Precision screwdriver 1Pcs Tweezers pliers 1Pcs blow mould box



27PCS COMBINED TOOL KITS



Item no.	Contents
90 90 10 19	1Pcs Flat gourd-form handle 1Pcs 4.5" Long nose pliers 1Pcs 6" Combination pliers 1Pcs PVC tape 1Pcs Bits holder 10Pcs Bits 1Pcs 8" Adjustable wrench 1Pcs Electrical voltage tester 1Pcs Utility knife 8Pcs 1.5-6mm Hex key 1Pcs Blow mould box

79PCS COMBINED TOOL KITS



Item no.	Contents
90 90 10 21	1Pcs 7" Combination pliers 1Pcs 8" Adjustable wrench 1Pcs Electrical voltage tester 1Pcs Utility knife 2Pcs 100x6 +- Screwdriver 1Pcs 2m Measuring tape 1Pcs Claw hammer 30Pcs Steel nail 40Pcs Screw 1Pcs Blow mould box

12PCS COMBINED TOOL KITS



Item no.	Contents
90 90 10 23	1Pcs Utility knife 2Pcs 100x6 +- High-level screwdriver 1Pcs 8" Adjustable wrench 1Pcs 9" Water pump pliers 1Pcs Seal strips 1Pcs 7" Combination pliers 1Pcs 2m Measuring tape 1Pcs Claw hammer 1Pcs Electrical voltage tester 1Pcs Flashlight 1Pcs Blow mould box

9PCS COMBINED TOOL KITS



Item no.	Contents
90 90 10 20	1Pcs 6" Combination pliers 1Pcs 6" Adjustable wrench 1Pcs Electrical voltage tester 1Pcs Alloy torch 2Pcs 100x6 +- Screwdriver 1Pcs Utility knife 1Pcs 2m Measuring tape 1Pcs Blow mould box

11PCS COMBINED TOOL KITS



Item no.	Contents
90 90 10 22	1Pcs 2m Measuring tape 2Pcs 100x6 +- High-level screwdriver 1Pcs 7" Combination pliers 1Pcs 8" Adjustable wrench 1Pcs Electrical tester 1Pcs Claw hammer 1Pcs PVC tape 2Pcs (-)2.4(+):PHO Precision screwdriver 1Pcs Blow mould box

16PCS COMBINED TOOL KITS



Item no.	Contents
90 90 10 24	1Pcs Utility knife 1Pcs Electrical voltage tester 1Pcs PVC tape 5Pcs 2-6mm Hex key 2Pcs 100x6 +- Screwdriver 1Pcs 75x3.2 + Screwdriver 1Pcs 2m Measuring tape 1Pcs 7" Combination pliers 1Pcs 8" Adjustable wrench 1Pcs Claw hammer 1Pcs Blow mould box

BOXES, CABINETS AND KITS

21PCS COMBINED TOOL KITS



Item no.	Contents
90 90 10 25	2Pcs 100x6 +- Screwdriver
	1Pcs 6" Long nose pliers
	1Pcs 6" Combination pliers
	1Pcs Inductive digital voltage tester
	1Pcs Small aluminium saw frame
	1Pcs PVC tape
	5Pcs 2-6mm Hex key
	1Pcs Utility knife
	1Pcs 8" Adjustable wrench
	1Pcs Claw hammer
	2Pcs (-)2.4(+):PHO Precision screwdriver
	1Pcs Scissor
	1Pcs Fittings box
	1Pcs 2m Measuring tape
	1Pcs Blow mould box

49PCS COMBINED TOOL KITS



Item no.	Contents
90 90 10 26	1Pcs Machinist hammer
	1Pcs Small aluminium saw frame
	1Pcs Electrical voltage tester
	1Pcs 2m Measuring tape
	2Pcs 100x6 +- Screwdriver
	2Pcs 150x3.2 +- Screwdriver
	1Pcs Scissor
	1Pcs 6" Long nose pliers
	1Pcs 7" Combination pliers
	5Pcs 2-6mm Hex key
	1Pcs 8" Adjustable wrench
	1Pcs 9" Water pump pliers
	1Pcs Utility knife
	1Pcs Tweezers pliers
	1Pcs PVC tape
	1Pcs Square handle with ball
	1Pcs Bits holder
	10Pcs Bits
	9Pcs 1/4"(5-13mm) Hexagonal socket
	6Pcs 8-19mm Combination wrench

58PCS COMBINED TOOL KITS



Item no.	Contents
90 90 10 27	8Pcs 1.5-6mm Hex key
	1Pcs Inductive digital voltage tester
	1Pcs 8" Adjustable wrench
	1Pcs 6" Long nose pliers
	1Pcs 7" Combination pliers
	1Pcs Utility knife
	1Pcs Claw hammer
	6Pcs 8-19mm Combination wrench
	1Pcs 2m Measuring tape
	2Pcs 100x6 +- Rubber screwdriver
	2Pcs 38x6 +- Screwdriver
	1Pcs Flashlight
	1Pcs Hacksaw frame
	20Pcs Bits
	1Pcs Bits holder
	9Pcs 9pcs 1/2" sockets
	1Pcs Blow mould box

42PCS COMBINED TOOL KITS



Item no.	Contents
90 90 10 29	5Pcs 2-6mm Hex key
	1Pcs Seal strips
	1Pcs PVC tape
	1Pcs 300mm Level
	7Pcs Electric drill bits
	1Pcs Electric drill handle
	1Pcs 500w/13mm Electric drill
	1Pcs Hacksaw frame
	1Pcs Spare saw blades
	1Pcs Electrical voltage tester
	1Pcs 8" Adjustable wrench
	1Pcs 6" Long nose pliers
	1Pcs 8" Combination pliers
	1Pcs Utility knife
	1Pcs 5m Measuring tape
	1Pcs Pipe wrench
	1Pcs Ball head hammer
	1Pcs Caulking gun
	1Pcs Pipe cutter
	2Pcs Rubber screwdrivers
	10Pcs Blades

60PCS COMBINED TOOL KITS



Item no.	Contents
90 90 10 28	2Pcs 100x6 +- Screwdriver
	2Pcs 150x3.2 +- Screwdriver
	5Pcs 2-6mm Hex key
	1Pcs 8" Adjustable wrench
	7Pcs Utility knife
	1Pcs 3m Measuring tape
	1Pcs Inductive digital voltage tester
	1Pcs Small saw frame with a plastic handle
	1Pcs Spare saw blades
	1Pcs PVC tape
	10Pcs Bits
	1Pcs Desoldering pump
	1Pcs Wire stripper
	1Pcs Multimeter
	1Pcs Soldering iron
	1Pcs Tweezers pliers
	1Pcs Square handle with ball
	1Pcs Solder wire
	1Pcs Machinist hammer
	1Pcs 6" Long nose pliers
	1Pcs 7" Combination pliers
	1Pcs 6" Diagonal pliers
	6Pcs Screwdriver case
	9Pcs 5-13mm 1/4" sockets
	1Pcs 1/4" bits holder
	1Pcs Blow mould box

62PCS UNIVERSAL TOOL SET, 1/4" & 3/8" DR.

- ▶ All in folding type blow mold case.
- ▶ Packing: color box



Item no.	Contents
90 90 10 30	<p>1/4" drive:</p> <p>9 - sockets: 5-6-7-8-9-10-11-12-13 mm</p> <p>1 - spinner handle with 2-tone soft grip</p> <p>3/8" drive:</p> <p>7 - sockets: 10-11-12-13-14-17-19 mm</p> <p>1 - ratchet handle with 2-tone grip</p> <p>1 - 70 mm extension bar</p> <p>1 - 21 mm (13/16") spark plug socket</p> <p>8 - hex key wrenches: 1.5-2-2.5-3-4-5-5.5-6 mm</p> <p>1 - 1/4" (m) x 3/8" (f) adaptor</p> <p>5 - combination wrenches: 8-10-12-13-14 mm</p> <p>1 - pvc tape</p> <p>1 - 60 mm bit holder</p> <p>1 - utility knife</p> <p>2 - screwdrivers:</p> <p>1-slotted: 6 x 100 mm</p> <p>1-Phillips no.2 x 100 mm</p> <p>1 - 3-way ratchet screwdriver handle</p> <p>1 - 6" combination pliers w/2-tone vinyl grips</p> <p>1 - 200 mm adjustable wrench w/2-tone vinyl grips</p> <p>1 - 240 mm waterpump pliers w/2-tone vinyl grips</p> <p>18 - 25 mm (l) 1/4" hex bits (cr-v):</p> <p>3 - slotted: 4-5.5-7 mm</p> <p>3 - hex: 4-5-6 mm</p> <p>5 - tx: t10-t15-t20-t25-t30</p> <p>3 - pozidriv: no.1-2-3</p> <p>3 - phillips: no.1-2-3</p> <p>1 - socket adaptor</p> <p>1Pcs Blow mould box</p>

61 PCS ALUMINUM TOOL KIT



Item no.	Contents
90 90 10 31	<p>2 - mini pliers with vinyl grips, forged carbon steel, hardened & polished:</p> <p>1 - 115 mm (l) diagonal cutting pliers</p> <p>1 - 115 mm (l) combination pliers</p> <p>6 - precision screwdrivers, carbon steel:</p> <p>3 - phillips: no.00-0-1</p> <p>3 - slotted: 1.2-2-3 mm</p> <p>9 - 1/4" dr. sockets, carbon steel, non-hardened:</p> <p>5-6-7-8-9-10-11-12-13 mm</p> <p>8 - hex key wrenches: 1.5-2-2.5-3-4-5-5.5-6 mm</p> <p>1 - screwdriver handle for 1/4" hex bits</p> <p>1 - knife</p> <p>30 - 25 mm (l) carbon steel bits:</p> <p>5 - slotted: 3-4-4.5-5-6 mm</p> <p>4 - phillips: no.0-1-2-3</p> <p>4 - pozidriv: no.0-1-2-3</p> <p>6 - hex: 2-2.5-3-4-5-6 mm</p> <p>7 - tx: t10-t15-t20-t25-t27-t30-t40</p> <p>3 - robertson: s1-s2-s3</p> <p>1 - socket adaptor</p> <p>1 - pvc insulated tape</p> <p>1 - tweezers</p> <p>1 - assorted fastener in box</p> <p>1Pcs Blow mould box</p>

24PCS RATCHET SCREWDRIVER & BIT SET

- ▶ All in window blow mold case.
- ▶ Packing: color sleeve w/shrink



Item no.	Contents
90 90 10 32	<p>carbon steel sockets & cr-v steel bits.</p> <p>1 - ratchet screwdriver with 2-tone handle</p> <p>1 - 300 mm steel flexible extension bit holder</p> <p>9 - sockets (non-hardened): 5-6-7-8-9-10-11-12-13 mm</p> <p>1 - 55 mm (l) magnetic bit holder</p> <p>11 - bits with holder: 2 - slotted: 5-7 mm</p> <p>3 - phillips: no.1-2-3</p> <p>3 - pozidriv: no.1-2-3</p> <p>2 - tx: t15-t20</p> <p>1 - adaptor</p> <p>1Pcs Blow mould box</p>

BICYCLE REPAIRING TOOL KIT

- ▶ All the bits and sheet rubbers are packed in white blow mould box



Item no.	Contents
90 90 10 33	<p>45# steel</p> <p>3 - hex key:4,5,6mm</p> <p>1 - adjustable wrench</p> <p>1 - ratchet handle</p> <p>3 - sockets:8,9,10mm</p> <p>2 - pry bars,45# steel,chrome-plated</p> <p>1 - spoke key</p> <p>5 - bits:2 slotted,3 phillips,25mm adaptor</p> <p>6 - sheet rubbers:1pc 32*50mm, 2pcs 25*32mm,2pcs φ25mm</p> <p>1 - 6g glue</p> <p>1Pcs Blow mould box</p>

125PCS COMBINED TOOL KITS



Item no.	Contents
90 90 00 26	72Pcs tool kits A+B+C
90 90 00 27	126Pcs tool kits A+B+D
90 90 00 28	125Pcs tool kits A+B+E
90 90 00 29	103Pcs tool kits A+C+D
90 90 00 30	104Pcs tool kits A+C+E



A:
14pcs 1/2" socket
Din3124 standard, crv, satin chrome plated
14-15-16-17-18-19-20-21-22-23-24-27-30-32mm
10pcs 1/4"x25mm socket
Din3124 standard, crv, satin chrome plated
4-5-6-7-8-9-10-11-12-13mm
2 pcs crv quick release ratchet handle 1/4" & 1/2"
(With 72 teeth) din 3122 standard, satin chrome
Plated, double color tpr handle.
4pcs crv extention bars
1/4"x50, 1/4"x100, 1/2"x125, 1/2"x250mm
Din 3123 standard, satin chrome plated, knurled
Handle.
1pcs 1/2" crv adaptor, hardened, satin chrome .
2pcs spark plug socket: 16mm + 21mm
Crv, hardened, satin chrome.
2pcs universal joint 1/4" & 1/2"
Din 3123 standard, satin chrome .
1pcs 1/4" sliding bar 6x114mm
Din 3122 standard, satin chrome .
1pc 1/4" sock handle 8x65mm
Crv, satin chrome.
1pc flexible shafts 1/4"x150mm



B:
6pcs crv double open end wrench
Din3110 standard
6x7,8x9,10x11,12x13,14x15,16x17mm
1pcs 8" adjustable wrench
Carbon steel, head polished, satin chrome, soft
Plastic grip.
1pcs 3/8" ratchet handle
1pcs 3/8"x1/4" adaptor
9pcs hex key 1.5-2-2.5-3-4-5-6-8-10mm

Extra type, crv, satin chrome.
9pcs torx hex key t10-15-20-25-27-30-40-45-50
Crv, satin chrome.



C:
10" water pump pliers
7" combination pliers
8" slip nose pliers
1pcs machinist's hammer 300g
(Din1041, gs approved, fiberglass handle)
1pcs measuring tape 3mx16mm
1pcs multi- purpose knife
Including 3pcs blade 9mm



D:
7pcs electrician's screwdrivers (gs approval):
Ph: ph0x60, ph1x80, ph2x100,
Sl: 0.5x3x100, 0.8x4x100, 1.0x5.5x125, 1.2x6.5x150mm
1pcs voltage tester ce/gs approval
0.5x3x60mm, 250~100v, 1000kw
1pcs reversable ratchet handle
51pcs crv bits set plus 1pcs plastic case:
1pc 60mm quick change bit holder
5pcs sl: 3-4-5-6-7mm
5pcs hex: 2-3-4-5-6mm
9pcs torx with central hole:
T8h-t10h-t15h-t20h-t25h-t27h-t30h-t35h-t40h
9pcs torx : t8-t10-t15-t20-t25-t27-t30-t40-t45
8pcs ph: 2xph0-2xph1-2xph2-2xph3
4pcs pz: pz0-pz1-pz2-pz3
4pcs y: 1-2-3-4
3pcs x: 6-8-10
3pcs sl with central hole: 6-8-10mm



E::
7pcs screwdriver with hex bloster on shank
Din5265 & din8764, crv, satin chrome, black
And magnetic tips. 3x75mm, 4x100mm, 6.5x125mm,
8x150mm,
Ph1x80mm, ph2x100mm, ph3x150mm
1pcs reversable ratchet handle 17. 5
1pcs crv bits set plus 1pcs plastic case:
1pc 60mm quick change bit holder
5pcs sl: 3-4-5-6-7mm
5pcs hex: 2-3-4-5-6mm
9pcs torx with central hole:
T8h-t10h-t15h-t20h-t25h-t27h-t30h-t35h-t40h
9pcs torx : t8-t10-t15-t20-t25-t27-t30-t40-t45
8pcs ph: 2xph0-2xph1-2xph2-2xph3
4pcs pz: pz0-pz1-pz2-pz3
4pcs y: 1-2-3-4
3pcs x: 6-8-10
3pcs sl with central hole: 6-8-10mm
9pcs torx :
T8-t10-t15-t20-t25-t27-t30-t40-t45
8pcs ph: 2xph0-2xph1-2xph2-2xph3
4pcs pz: pz0-pz1-pz2-pz3
4pcs y: 1-2-3-4
3pcs x: 6-8-10
3pcs sl with central hole: 6-8-10mm

118PCS COMBINED TOOL KITS



Item no.	Contents
90 90 00 01	4pcs plier 5", carbon steel: Combination plier, Long nose plier, Diagonal plier and End cutter 6pcs screwdrivers, CRV: PH3X100, PH2X100, 6.5X100, PH1X75, PH0X75, 5X75 24pcs 50MM bits, carbon steel 30pcs 25MM bits, carbon steel 1pc 3.6V rechargeable screwdriver, with 1 charger plug 8pcs hex key set, carbon steel: 1.5-2.0-2.5-3.0-4.0-5.0-6.0-8.0mm, 1box hardware assortments 1pc insulated tape 1pc measuring tape 2m, 1pc machinist's hammer 200g, 1pc universal knife, 1pc adjustable wrench 6", carbon steel 1pc electric tester 18pcs 1/2" sockets, carbon steel without heat-treatment: 10-11-12-13-14-15-16-17-18-19-20-21-22-23-24-27-30-32mm, 10pcs 1/4" sockets, carbon steel without heat-treatment: 4-5-6-7-8-9-10-11-12-13mm, 2pcs ratchet wrenches, carbon steel 1pc bit adapter, carbon steel without heat-treatment 2pcs sliding bars, 1/2"x250mm, 1/4"x110mm, carbon steel without heat-treatment 2pcs extension bars, 1/2"x125mm, 1/4"x50mm, carbon steel without heat-treatment 1pc 1/2"x21 spark plug socket, carbon steel without heat-treatment 1pc screwdriver handle, carbon steel without heat-treatment 1pc metal tool box

118PCS COMBINED TOOL KITS



Item no.	Contents
90 90 00 03	155Pcs tool kits A+B+C
90 90 00 04	148Pcs tool kits A+D+E
90 90 00 05	145Pcs tool kits A+C+E



A:

- 14pcs 1/2" socket 14-15-16-17-18-19-20-21-22-23-24-27-30-32mm
- 12pcs 1/4" x25mm socket: 4-4.5-5-6-5.5-6-7-8-9-10-11-12-13mm
- 12pcs 1/4"x32mm socket +bit
- Hex: 8-6-5-4-3mm ph: ph1, ph2 sl: 3-4-5-5-6-5-8mm"
- Quick release ratchet handle(with 72 teeth)
- 4pcs extension bars: 1/4"x50, 1/4"x100, 1/2"x125, 1/2"x250mm
- 1pc 1/2" adaptor
- 2pcs spark plug socket: 16mm+21mm
- 2pcs extension bars 1/4"+1/2"
- 1pc 1/4" sliding bar
- 1pc 1/4" sock handle
- 1pc flexible shafts 1/4"x150mm
- 1pc adaptor 1/4"x25mm
- 1pc adaptor 1/4"x25mm
- 1pc 1/4" t-ratchet handle
- 51pcs cr-v bits set:
- 1pc 60mm quick change bit holder
- 5pcs sl: 3-4-5-6-7mm
- 5pcs hex: 2-3-4-5-6mm
- 9pcs torx: t8-t10-t15-t20-t25-t27-t30-t40-t45
- 8pcs ph: 2"ph0-2"ph1-2"ph2-2"ph3
- 4pcs pz: pz0- pz1- pz2- pz3- pz4
- 4pcs y: 1-2-3-4mm
- 3pcs x: 6-8-10mm
- 3pcs sl with central hole: 6-8-10mm"
- 9pcs.Hexagon socket screw keys
- 9pcs tx key set: t10-t15-t20-t25-t27-t30-t40-t45-t50



- B:**
- 1pc 9mm multi-purpose knife
 - 2pcs precision screwdrivers:
Slotted: 3.0x50mm ph0x50mm
 - 5pcs gs-approval insulated screwdrivers: ph1x80, Ph1x80 ph2x100, 0.8x4x100, 1.0x5.5x125, 1.2x6.5x150
 - 1pc gs-approval voltage tester 60mm
 - 10pcs punch and chisel set
 - 1pc machinist's hammer 300g
 - 1pc electrician's scissors



- C:**
- 1pc hand saw with 2 blades
 - 1pc measure tape 3mx16mm
 - 1pc 8" adjustable wrench
 - 3pcs pliers:
1pc 6" combination pliers;
1pc 6" long nose pliers;
1pc 10" waterpump pliers
 - 1pc precision vernier caliper 0-150x0.05



- D:**
- 6pcs crv combination wrench 10/12/14/16/18/20mm
 - 1pc measuring tape: 3mx16mm
 - 1pc 200mm adjustable wrench
 - 1pc 250mm groove joint pliers(gs approval)
 - 1pc 160mm combination pliers(gs approval)
 - 1pc 160mm long nose pliers(gs approval)



- E:**
- 1pc 9mm utility knife
 - 2pcs precision screwdrivers:
Slotted: 3.0x50mm
Phillips: ph0x50mm
 - 6pcs crv screwdriver (gs approval):
Slotted: 8.0x150mm, 6.5x100mm, 5.5x75mm
Phillips: ph3x150mm, ph2x100mm, ph1x75mm
 - 1pc voltage tester (gs approval): 100-250v
 - 1pc 300g mechanist's hammer (gs approval)
 - 1pc electrician's scissors

37PCS COMBI-TOOL SET

► Packed in blow mould case with transparent window



Item no.	Contents
90 90 00 07	1pc 125mm snip nose pliers 1pc 6 adj. wrench with red insulation 1 mini-spirit level 1pc bit driver 32pcs 25mm chrome-vanadium bits 1pc magnetic bit holder

37PCS COM-TOOL KIT

► Packed in blow mould case with transparent or cover window



Item no.	Contents
90 90 00 08	1pc power ratchet screwdriver handle, with 2 components soft grip 1pc 6 adj. wrench with power comfortable handle. 1pc reversible ratchet handle 1/4 , with 2 components soft grip 20 Cr-V 25mm bits SL: 3, 4, 5, 6 PH: 1, 2, 3 PZ: 0, 1, 2, 3 TORX: 10, 15, 20, 25 HEX 3, 4, 5, 6 1pc extension bar 1pc 25mm Cr-V adaptor 12pcs sockets: 4, 4.5, 5, 5.5, 6, 7, 8, 9, 10, 11, 12, 13mm

45PCS COMBINED TOOL SET

► Packed in nylon zip bag + double blister



Item no.	Contents
90 90 00 09	1pc 6" stub adj. Wrench with 2 components handle 1pc 1/4" Dr ratchet handle with 2 components handle 1pc stub powerful ratchet bit driver 2pcs precision screwdriver 5pcs insulated screwdriver 1000V SL: 3x100, 4x100, 5.5x125mm PH: 1#x80mm, 2#x100mm 2pcs mini-pliers with 2 components TPT handle: Combination pliers, side cutter 1pc 50mm bit extension bar 1pc 65mm bit extension bar 1pc 140mm voltage tester, GS-approval 9pcs sockets: 5, 6, 7, 8, 9, 10, 11, 12, 13mm 20pcs 25mm Cr-V bits: SL:3, 4, 5, 6 mm PH:0, 1, 2, 3 PZ: 0, 1, 2, 3 Torx:10, 15, 20, 25 Hex:3, 4, 5, 6

40PCS TOOL SET

► Packed in blow mold case



Item no.	Contents
90 90 00 10	1pc 6" long nose plier, polished head, double color mat dipped handle 8pcs Hex key 1/16", 5/64", 3/32", 1/8", 5/32", 3/16", 7/32", 1/4" 6pcs precision screwdriver 1.0, 1.4, 2.0, 2.4, 2.9, 3.8mm 1 utility knife 1pc ratchet 1/4" Dr handle 1pc bit extension bar 1pc socket adaptor 1pc bit driver handle with 1/4" Dr end of the handle 10pcs 25mm Cr-V bits SL: 4, 5, 6, 7 mm PH: 1, 2, 3 PZ: 1, 2, 3 11pcs sockets: 4, 4.5, 5, 6, 7, 8, 9, 10, 11, 12, 13mm

56PCS COMBINED TOOL SET



Item no.	Contents
90 90 00 11	9pcs screwdrivers, made from expert CrV steel, hardened, matte finished, magnetic tips, black finish, with double components anti-slip TPR handle, ergonomically designed. SL: 6X38mm 5X75mm 6X100mm 8X150mm PH: #2X38mm #1X75mm #2X100mm #3X150mm 1pcs magnetic bit driver, 10X50mm 2pcs precision screwdrivers: slot 2.5X50mm,PH00X50mm. 9pcs 1/4" 25mm CrV sockets, chrome plated,5-6-7-8-9-10-11-12-13mm. 20pcs 25mm CrV bits: SL:4-5-6mm PH:PH0-PH1-PH2-PH3 PZ:PZ1-PZ2-PZ3 Torx:T10-T15-T20-T25-T30 Hex:3-4-5-6 1pc CrV adaptor 1pc ratchet handle,1/4"Dr. 1pc adjustable wrench, chrome plated, with double components plastic handle 1pc 6" combination pliers and long nose pliers, satin nickel plated, with double components anti-slip plastic handle 9pc hex key, nickel plated, in plastic holder,1.5-2-2.5-3-4-5-6-8-10mm 1pc 50mm socket adaptor and 100mm socket adaptor 1pc 1/4" universal adaptor

BLACK PLASTIC TOOLBOX WITH FOUR BLACK TOOL TRAYS

- ▶ THE 4 TOOL TRAYS WILL BE LOCKED BY LONG BIC CABLE TIE
- ▶ WITH COLOUR BOX
- ▶ HANDLE OF TOOLBOX OUTSIDE THE COLOUR BOX
- ▶ DIN A 6 PRINTING CARD /TAG IN CUSTOMER'S MAKE-UP FIXED AT THE HANDLE



Item no.	Contents
90 90 00 16	1st tool tray: 6 pcs electrician screwdrivers,cr-v: flat:3*100,4*100,5.5*125,6.5*150 mm phillips:#1.80,#2*100 mm, 2pcs precision screwdriver each,cr-v, flat&phillips, -1pc.voltage tester 60 mm, 2nd tool tray: 1pc universal knife, 1pc ratchet screwdriver handle, 9pcs 1/4 dr. sockets: 5-6-7-8-9-10-11-12-13mm, 23 bits torx:t10-t15-t20-t25-t27-t30-t40 phillips:ph1-ph2-ph3 square:s1-s2 pozi:pz1-pz2-pz3 hex:#2/#3/#4/#5/#6 slotted:5-6-7 mm" -1pc.socket adapter, -1pc.bit adapter, -1pc.plastic box for screws and wall screws:50 pcs.3*30 mm, 30 pcs.4*40 mm,10 pcs.5*50 mm wall plugs:50 pcs.5 mm, 30 pcs.6 mm,10pcs.8 mm 3rd tool tray: -1 pc.machinest hammer -1 pc. mini hand saw with blade, -1 pc.torpedo level, -1 pc.insulation tape, 4th tool tray: -1 pc.combination plier 160 mm, -1pc.telephone plier 160 mm, -1 pc.waterpump plier 240 mm, -1 pc.adjustable wrench, -1 pc.measuring tape 3m*16mm, -1 pc.adjustable wrench, -1 pc.measuring tape 3m*16mm,

11PCS TOOL SET



Item no.	Contents
90 90 00 12	7 high quality electrician's screwdrivers, chrome-vanadium blades, din 7437 /7438, VDE, TÜV/GS approved 1 voltage tester, GS-approved 3 pliers with multilayered dull chromium plating, with 2-component-plastic handle with slip protection, GS approved

95PCS TOOL SET



Item no.	Contents
90 90 00 14	6Pcs VDE screwdriver 7Pcs go-through screwdriver 5Pcs precision screwdriver 1Pc 7in1 bits holder 40Pcs bits with 1 bits holder 1Pc flexible extension bar 1Pc 3/8" ratchet handle 18Pcs sockets 1Pc extension bar 1Pc spark plug 1Pc 3/8"M to 1/4"F adaptor 8Pcs hexkey 1Pc long nose plier 1Pc diagonal cutter 1Pc 8" adjustable wrench 1Pc multi-purpose knife

60PCS HOUSE HOLD TOOL SET

- ▶ IN FOLDABLE BLOW-MOULD-CASE WITH HANGING HOLES



Item no.	Contents
90 90 00 18	6pcs electrician screwdrivers (flat 3 x 100 / 4 x 100 / 5.5 x 125 /6.5 x 150 mm, phillips 1 x 80 / 2 x100) 2pcs precision screwdrivers (slotted / phillips) voltage tester 60 mm, torpedo level hand saw with blade, insulating tape machinest hammer assortment of staples (1000 x 6 mm),+nails +screws wall plugs in plastic box, tacker universal knife ratchet screwdriver handle 9 pcs. 1/4" dr. sockets, 23 bits,material is carbon steel,hardened socket adapter, measuring tape 3 m x 16 mm adjustable wrench, material is carbon steel water pump plier telephone plier

46 PCS TOOL SET

- ▶ Packed in blow mould case



Item no.	Contents
90 90 00 20	1PC Knife,with 6 blades 1pc 8" adjustable wrench 1pc 6" snip nose plier,1pc 6" combination plier,with dipped handle 1pc 8" multif scissors 6pcs precision screwdrivers 8pcs Hex keys 2pcs flat screwdrivers 1pc Claw hammer, with tubular steel handle,8 OZ 1pc measure tap,3m 1pc hacksaw with 1pc saw blades 9pcs sockets,material is carbon steel 1pc extention bars 11pcs bits,material is carbon steel 1pc quick release ratchet handle

100-PCS. TOOL KIT

► Packed in blow mould case



Item no.	Contents
90 90 00 19	1pc 9" water pump plier, carbon steel polish 1pc 10" locking grip plier 1pc Machinest hammer 1pc crimping plier 10pcs 1/2" sockets:10mm,11mm,12mm,13mm,14mm,15mm,17mm,19mm,22mm,24mm 2pc spark plug socket 1pc 1/2" Dr. 125mm extension bar 1pc quick release ratchet handle(with 72 teeth) 1pc T ratchet handle 1pc 1/4" T sliding bar 8pcs double open wrench: 10mm,11mm,12mm,13mm,14mm,15mm,17mm,19m 4pcs Hex key: 5mm,6mm,8mm,10mm, carbon steel ,black finish 40pcs accessories 1pc vottage test 1pc T ratchet handle 9pcs 1/4" sockets: 5mm,6mm,7mm,8mm,9mm,10mm,11mm,12mm,13mm 11pcs 1/4" bits: PH:1,2,3 SL:3,4,5,6,8 Hexgon:T15,T20,T30 5pcs screwdriver: PH:6X38,6X100 SL:6X38,6X100,8X200

75PCS TOOL SET



Item no.	Contents
90 90 00 21	810 W IMPACT DRILL 1pcs water pump plier 1pcs combination plier 2pcs screwdriver 1pcs machinest hammer 6pcs combination wrench, material is carbon steel 1pcs ratchet screwdriver handle 1pcs Ratchet handle 9pcs 1/4"x20mm socket set: 4-5-6-7-8-9-10-11-13mm 8pcs 1/2"x36mm sockets set: 10-11-12-13-14-17-19-21mm 24pcs bits ,harden ,phosphor plated 15pcs twister drill 1pcs measuring tape 1pcs voltage tester

135PCS TOOL SET WITH CABINET

► tool cabinets with 2pc inserts



Item no.	Contents
90 90 00 22	50pcs bits+1pc bits holder 14pcs 1/2" dr. sockets 12pcs 1/4" dr. sockets 12pcs socket bits 2pcs pliers 1pc water pump pliers 2pcs ratchet handles 12pcs sockets accessories 8pcs hex key 1pc measuring tape 1pc adjustable wrench 1pc utility knife 1pc voltage tester 8pcs screwdrivers 1pc quick change extension 1pc adaptor 1pc extension bar 1pc mini hand saw 1pc machinist's hammer

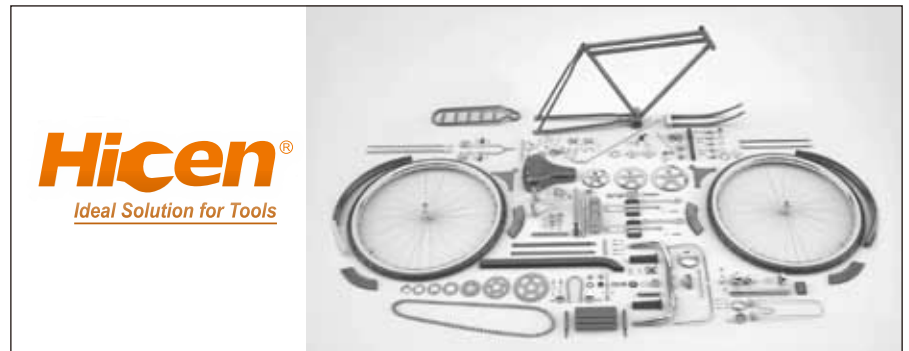

72PCS EMERGENCY TOOL SET



Item no.	Contents
90 90 00 31	2pc Screwdriver
	1pc Voltage tester
	1pc Slip joint plier
	3pc Combination spanners
	1pc Tire gauge
	1pc Wire stripper
	1pc Tape
	1pc Booster cable
	1pc Ratchet handle
	15pc Sockets
	1pc Extension bar
	2pc Spark plug sockets
	1pc Adaptor
	40pc Cable terminals

132PCS TOOL SET



Item no.	Contents
90 90 00 32	16pc Hexkeys
	1pc Knife
	1pc Long nose plier
	1pc Diagonal plier
	1pc Adjustable wrench
	5pc Combination spanner
	1pc Precision screwdriver blade holder
	1pc Bits holder
	1pc Claw hammer
	1pc Scissor
	1pc Measuring tape
	1pc Torpedo level
	20pc Bits
	80pc Hardwares

105PCS TOOL SET



Item no.	Contents
90 90 00 33	4pc Hexkeys
	3pc Precision screwdriver
	1pc Adjustable wrench
	1pc Knife
	1pc Long nose plier
	1pc Slip joint plier
	1pc Bits holder
	1pc Claw hammer
	1pc Scissor
	10pc Bits
	1pc Measuring Tape
	88pc Hardwares

36PCS EMERGENCY TOOL SET



Item no.	Contents
90 90 00 34	

39PCS TOOL SET



Item no.	Contents
90 90 00 35	8pc Hexkeys
	20pc Bits
	4pc Precision screwdrivers
	1pc Slip joint plier
	1pc Bits holder
	1pc Bit adaptor
	1pc Claw Hammer
	1pc Knife
	1pc Measuring Tape
	1pc Scissor

122PCS TOOL SET



Item no.	Contents
90 90 00 36	20pc Bits
	10pc Hexkeys
	4pc Precision screwdrivers
	1pc Slip joint pliers
	1pc Bits holder
	1pc bits adaptor
	1pc Knife
	1pc Claw hammer
	1pc Scissor
	1pc Measuring tape
	80pc Hardware

79PCS TOOL SET



Item no.	Contents
90 20 00 37	40pc Bits
	2pc Screwdriver
	1pc Bits holder
	1pc Kinfe
	15pc Sockets
	11pc Hex key
	1pc Ratchet handle
	1pc Adjustable wrench
	1pc Level
	1pc Spark plug socket
	1pc Extension bar
	1pc Adaptor
	1pc Long nose plier

116PCS TOOL SET



Item no.	Contents
90 20 00 39	1pc Longnose pliers
	1pc Adjustable wrench
	1pc Slip joint pliers
	2pc Screwdrivers
	1pc Bits holder
	20pc Bits
	1pc Torpedo level
	1pc Knife
	1pc Scissor
	1pc Measuring Tape
	5pc Precision screwdriver
	80pc hardwares

27PCS TOOL SET



Item no.	Contents
90 20 00 41	8pc Combination spanner
	1pc Measuring tape
	1pc Long nose pliers
	8pc Screwdrivers
	9pc Hexkeys

144PCS TOOL SET



Item no.	Contents
90 20 00 42	7pc Hexkeys
	5pc Combination spanners
	1pc Long nose pliers
	1pc Diagonal Pliers
	1pc Claw hammer
	1pc Torpedo level
	1pc Bits holder
	20pc Bits
	1pc Measuring tape
	2pc Screwdrivers
	1pc Voltage tester
	1pc Knife
	1pc Adjustable wrench
	100pc Hardwares

40PCS TOOL SET



Item no.	Contents
90 20 00 38	4pc Combination spanners
	2pc Precision screwdrivers
	1pc Knife
	1pc Long nose pliers
	1pc Torpedo level
	1pc Bits holder
	1pc Claw hammer
	20pc Bits
	8pc Hexkeys
	1pc Measuring Tape

47PCS TOOL SET



Item no.	Contents
90 20 00 40	1pc Knife
	1pc Adjustable wrench
	1pc Long nose pliers
	1pc Linesman pliers
	1pc Scissor
	6pc Precision screwdriver
	8pc Hexkeys
	2pc Screwdrivers
	1pc Claw hammer
	9pc Sockets
	1pc Measuring tape
	10pc Bits
	1pc Bits adaptor
	1pc Hack saw
	1pc Ratchet bits handle

166PCS TOOL SET



Item no.	Contents
90 90 00 43	1pc Adjustable wrench 1pc Knife 1pc Linesman pliers 1pc Long nose pliers 1pc Claw hammer 1pc Ratchet Handle 1pc Extension bar 1pc Spark plug socket 1pc Adaptor 18pc Sockets 6pc Combination spanner 1pc Ratchet bits holder 20pc Bits 1pc Measuring Tape 4pc Precision Screwdriver 1pc Torpedo level 16pc Hexkeys 90pc Hardwares

131PCS TOOL SET



Item no.	Contents
90 90 00 44	16pc Hexkeys 1pc Long nose pliers 1pc Adjustable wrench 1pc Bits holder 1pc Claw hammer 1pc Knife 1pc Torpedo level 1pc Measuring tape 6pc Precision screwdriver 20pc Bits 2pc Clamps 80pc Hardwares

29PCS TOOL SET



Item no.	Contents
90 90 00 45	5pc Hexkeys 6pc Precision Screwdriver 1pc Bits holder 1pc Adjustable wrench 1pc Long nose pliers 1pc Extension bar 4pc Sockets 10pc Bits

15PCS TOOL SET



Item no.	Contents
90 90 00 46	1pc Combination pliers 1pc Knife 1pc Claw Hammer 1pc Bits holder 1pc Adjustable wrench 10pc Bits

44PCS TOOL SET



Item no.	Contents
90 90 00 47	1pc Longnose pliers 1pc Bits holder 1pc Claw hammer 1pc Adjustabel wrench 40pc Hardware

42PCS TOOL SET



Item no.	Contents
90 90 00 48	8pc Hexkeys 10pc Bits 1pc Bits holder 1pc Knife 1pc Adjustable wrench 1pc Long nose pliers 16pc Sockets 1pc Ratchet handle 1pc Spark plug socket 1pc Extension bar 1pc Torch

7PCS TOOL SET



Item no.	Contents
90 90 00 49	2pc Screwdrivers 1pc Measuring tape 1pc Diagonal pliers 1pc Adjustable wrench 1pc Claw hammer 1pc Linesman pliers

11PCS TOOL SET



Item no.	Contents
90 90 00 50	1pc Adjustable Wrench 4pc Mini pliers 1pc Voltage tester 4pc precision screwdriver 1pc Torch

104PCS TOOL SET



Item no.	Contents
90 20 00 51	2pc Precision screwdriver 1pc Joint slip pliers 1pc Claw hammer 1pc Adjustable wrench 1pc Screwdriver 1pc Measuring tape 17pc Bits&adaptor 80pc Hardwares

110PCS TOOL SET



Item no.	Contents
90 20 00 52	1pc Long nose pliers 1pc Diagonal pliers 1pc Linesman pliers 2pc Screwdrivers 1pc Voltage tester 1pc Knife 1pc Claw hammer 1pc Tape 1pc Measuring tape 1pc Plastic box 99pc Hardwares

7PCS TOOL SET



Item no.	Contents
90 20 00 53	1pc Linesman pliers 2pc Screwdrivers 1pc Claw hammer 1pc Knife 1pc Measuring tape 1pc Adjustable wrench

142PCS TOOL SET



Item no.	Contents
90 20 00 54	1pc Hacksaw 1pc Voltage tester 2pc Clamps 1pc Scissor 1pc Long nose pliers 1pc Combination pliers 1pc Adjustable wrench 1pc Groove joint pliers 1pc Claw hammer 1pc Torpedo level 1pc Bits holder 10pc Bits 2pc Screwdrivers 8pc Hexkeys 1pc Measuring tape 1pc Tool box 108pc Hardwares

56PCS TOOL SET



Item no.	Contents
90 20 00 55	6 pcs combnation wrench 5 pcs screwdrivers 1 pc combnation plier 1 pc water pump plier 16 pcs sockets 1PC Universal Joint 1PC Extension Bar 2PC Spark Plug Socket 1PC Coupler 1PC Spinner Handle 1PC Machanical Hammer 14PCScrewdriver Bits 4PC Hex Key Wrench 1PC Quick Release Ratchel Handle

77PCS TOOL SET



Item no.	Contents
90 20 00 56	1 pc combantion plier 1 pc long nose plier 1 pc water pump wrench 1 pc Adjustable wrench 1 pc claw hammer 1 pc measuring tape 4 pcs screwdrivers 2 pc precision drivers 1 pc voltage tester 1 pc flashlight 1 pc house holder scissors 1 pc utility knife 1 pc insulated tape 60 pcs hardware set

99PCS TOOL SET



Item no.	Contents
90 90 00 57	8 pcs combination wrench 5 pcs screwdrivers 1 pc combination plier 1 pc water pump plier 1 pc crimping striper 29 pcs sockets 2PC Spark Plug Socket 2PC Universal Joint 2PC Extension Bar 2PC flexible Handle 1 pc spinner handle 1PC Mechanical Hammer 14PCScrewdriver Bits 4PCHex Key Wrench 1PC auto tester 25 pcs hardware set

72PCS TOOL SET



Item no.	Contents
90 90 00 58	8 pcs combination wrench 5 pcs screwdrivers 1 pc combination plier 1 pc water pump plier 29 pcs sockets 2PC Spark Plug Socket 2PC Universal Joint 2PC Extension Bar 2PC flexible Handle 1 pc spinner handle 1PC Mechanical Hammer 14PCScrewdriver Bits 4PCHex Key Wrench

45PCS TOOL SET



Item no.	Contents
90 90 00 59	8 pcs combination wrench 5 pcs screwdrivers 1 pc combination plier 1 pc water pump plier 18 pcs sockets 1PC Universal Joint 2PC Extension Bar 1PC sliding bar 1PC flexible Handle 1PC Mechanical Hammer 4PCHex Key Wrench 1PCQuick Release Ratchel Handle 1PC auto tester

75PCS TOOL SET



Item no.	Contents
90 90 00 60	6 pcs insulated screwdrivers 2 pcs precision driver 1 pc bit holder 1 pc voltage tester 1 pc Multi-purpose knife 1 pc Torpedo level 1 pc mini hack saw frame 1 pc adjustable wrench 1 pc combination plier 1 pc long nose plier 1 pc water pump plier 1 pc measuring tape 1 pc staple gun 1 pc insulated tape 1 pc machinist hammer 9 pcs sockets 1 pc bit adaptor 24 pcs screwdriver bits 20 pcs hardware sets

77PCS TOOL SET



Item no.	Contents
90 90 00 61	11 pcs combination wrench 7 pcs allen wrench 23 pcs sockets 3 pcs extension bar 1 pc sliding bar 1 pc spark pulg socket 2 pcs universal adaptor 2 pcs ratchet handle 4 pcs flexible socket wrench 22 pcs screwdriver bits

198PCS ALUMINUM TOOL BOX



Item no. Contents

90 90 00 62	1 pc carpenter plier
	1 pc water pump plier
	1 pc combination plier
	1 pc long nose plier
	4 pcs retainer pliers with binding clips
	1 pc diagonal plier
	1 pc scissors
	1 pc knife
	1 pc flashlight
	1 pc pick up tool
	5 pcs chisel
	3 pcs Precision screwdrivers
	32 pcs screwdriver bits
	1 pc voltage tester
	5 pcs screwdrivers
	1 pc bits handle
	1 pc hack saw frame
	9 pcs hex key wrench
	1 pc adjustable wrench
	1 pc machinist hammer
	1 pc measuring tape
	26 pcs sockets
	4 pcs extension bar
	2 pcs plug sockets
	2 pcs universal joint
	1 pc sliding bar
	1 pc coupler
	9 pcs combination wrench
	1 pc vernier caliper
	2 pcs ratchet handle
	76 pcs fasteners

120 PC ALUMINUM TOOL BOX



Item no. Contents

90 20 00 63	1 pc diagonal cutter plier
	1 pc long nose plier
	1 pc combination plier
	1 pc water pump plier
	1 pc tower pincer
	4 pcs screwdrivers
	4 pcs long screwdriver bits with holder
	9 pcs combination wrench
	1 pc Ad wrench
	1 pc utility knife
	1 pc aluminum level
	1 pc measuring tape
	1 pc machinist hammer
	1 pc garden scissor
	1 pc main tester
	1 pc mini hacksaw
	9 pcs hex wrench
	31 pc screwdriver bits
	23 pcs sockets
	3 pcs extension bar
	2 pcs ratchet handle
	2 pcs universal joint
	2 pcs sliding bar
	1 pc magnetic bit holder
	1 pc socket adaptor
	2 pcs spark plug socket
	1 pc fast release joint
	1 pc circlip plier
	1 pc flash light
	1 pc crimping plier
	1 pc terminal set
	1 pc vernier caliper
	5 pcs punch set
	1 pc bit holder

134PCS ALUMINUM TOOL BOX



Item no. Contents

90 20 00 64	1 pc combination plier
	1 pc long nose plier
	1 pc diagonal cutter plier
	1 pc water pump plier
	1 pc file
	1 pc multi-purpose knife
	1 case knife blade
	1 pc crimping plier
	6 pcs screwdrivers
	2 pcs precision driver
	1 pc spinner handle
	1 pc ratchet handle
	17 pcs sockets
	1 pc coupler
	1 pc socket adaptor
	1 pc spark plug socket
	2 pcs extension bar
	1 pc voltage tester
	8 pcs combination wrench
	1 pc mini hacksaw
	6 pcs saw blades
	1 pc utility knife
	9 pcs hex key set
	1 pc machinist hammer
	31 pcs screwdriver bits

186PCS ALUMINUM TOOL BOX



Item no. Contents

90 20 00 65	11 pcs screwdrivers
	3 pcs insulated screwdrivers
	1 pc bit holder
	1 pc Voltage tester
	25 pcs screwdriver bits
	1 pc magnetic bit holder
	9 pcs hex key set
	6 pcs precision screwdrivers
	1 pc magnetic pick up tool
	1 pc crimping plier
	1 pc locking plier
	1 pc utility knife
	1 pc machinist hammer
	1 pc Alu level
	1 pc measuring tap
	1 pc glue gun
	2 pcs glues
	2 pcs spring clamp
	1 pc combination plier
	1 pc long nose plier
	1 pc diagonal plier
	1 pc water pump plier
	10 pcs combination plier
	29 pcs sockets
	2 pcs spark plug socket
	3 pcs extension bar
	2 pcs sliding bar
	2 pc universal joint
	1 pc flexible socket adaptor
	1 pc spinner handle
	2 pcs ratchet handle
	60 pcs hardware set

186PCS ALUMINUM TOOL KIT



Item no. Contents

90 90 00 66



1ST TOOL TRAY:

- 10 combination wrenches: 6-8-10-11-12-13-14-15-17-19mm
- 1 - 7.5" diagonal plier
- 1 - 8" long nose plier
- 1 - 8" adjustable wrench
- 1 - 6" slip joint pliers
- 1 - 10" d4 water pump plier



2ST TOOL TRAY:

- 1 - 1/2" ratchet handle, 24 teeth, with 2-tone grip
- 1 - 1/4" ratchet handle, 24 teeth, with 2-tone grip
- 12 - 1/4" dr sockets: 4, 4.5, 5, 5.5, 6, 7, 8, 9, 10, 11, 12, 13mm
- 17 - 1/2" dr sockets: 10, 11, 12, 13, 14, 15, 16, 17, 18, 19, 20, 21, 22, 23, 24, 27, 30mm
- 1 - 1/4" sliding bar 6*100mm
- 1 - 1/4"*100mm extension bar
- 1 - 1/4"*50mm extension bar
- 1 - 1/4"dr universal joint
- 1 - 1/4" square black handle
- 1 - 1/2"*16mm spark plug socket
- 1 - 1/2"*21mm spark plug socket
- 1 - 1/2"*10" extension bar
- 1 - 1/2"dr universal joint
- 1 - 150mm hose
- 1 - 5bl magnetic pick-up tool



3ST TOOL TRAY:

- 9 - hex key set, carbon steel, nickel plated, with red plastic holder
- 1 - ratchet handle, with 2-tone grip
- 1 - 100-250v voltage tester
- 24 - 25mm bits, carbon steel, 2 red holders, 1pc 3" magnetic extension bar
- 1 - 25mm hook driver
- 11 - screwdrivers, carbon steel, with heat treatment, black finished magnetic tips:
 - 5 - slotted: 3*75, 3*100, 5*75, 6*100, 6*38mm
 - 6 - phillips: 3*75, 3*100, 5*75, 6*100, 6*38, 8*150mm
- 3 - insulated screwdrivers:
 - 2 - slotted: 4*100, 5.5*125mm
 - 1 - phillips: 4*100mm
- 6 - precision screwdrivers



4ST TOOL TRAY:

- 1 - 12oz claw hammer, 2-tone tpr handle
- 1 - 7" locking plier, carbon steel, nickel plated
- 1 - 8" crimping plier, 2-tone handle
- 1 - 10y tape, i.D.: 3.7cm, o.D.: 5.4cm
- 1 - 10" spiri lecel, aluminum alloy, with shrink
- 2 - 3" plastic spring clamps
- 1 - transparent organizer with 60pcs components
- 1 - 5m tape measure, 2-tone case
- 1 - zinc alloy knife, 2-tone body
- 1 - 10w hot glue gun, with 4 glue sticks
- 1 - abs roller tool box

